



GOVERNMENT OF TAMILNADU

HIGHER SECONDARY FIRST YEAR

# COMPUTER APPLICATIONS

A publication under Free Textbook Programme of Government of Tamil Nadu

Department of School Education

Untouchability is Inhuman and a Crime

## Government of Tamil Nadu

First Edition - 2018

Revised Edition - 2019, 2020, 2022

(Published under New syllabus)

NOT FOR SALE

## Content Creation



State Council of Educational  
Research and Training  
© SCERT 2018

## Printing & Publishing



Tamil Nadu Textbook and Educational  
Services Corporation

[www.textbooksonline.tn.nic.in](http://www.textbooksonline.tn.nic.in)

## PREFACE

Human civilization achieved the highest peak with the development of computer known as "Computer era".

Literate are those who have the knowledge in using the computer whereas others are considered illiterate inspite of the other degrees obtained.

The growth of the nation at present lies in the hands of the youth, hence the content of this book is prepared in such a way so as to attain utmost knowledge considering the future needs of the youth.

## HOW TO USE THE BOOK?

- This book does not require prior knowledge in computer Technology
- Each unit comprises of simple activities and demonstrations which can be done by the teacher and also students.
- Technical terminologies are listed in glossary for easy understanding
- The " Do you know?" boxes enrich the knowledge of reader with additional information
- Workshops are introduced to solve the exercises using software applications
- QR codes are used to link supporting additional materials in digital form

### How to get connected to QR Code?

- o Download the QR code scanner from the google play store/ apple app store into your smartphone
- o Open the QR code scanner application
- o Once the scanner button in the application is clicked, camera opens and then bring it closer to the QR code in the textbook.
- o Once the camera detects the QR code, a URL appears in the screen. Click the URL and go to the content page.



## CAREER GUIDANCE AFTER 12<sup>TH</sup>

COURSES	COLLEGES/ UNIVERSITIES	PROFESSION
B.E / B.Tech	All University and their affiliated Colleges and Self financing Colleges in India and Abroad.	Software Engineer, Hardware Engineer, Software Development, Healthcare Section, IT & ITes
<b>Science and Humanities</b>		
B.Sc (Computer Science) BCA B.Sc ( Maths, Physics, Chemistry, Bio-Chemistry, Geography, journalism, Library Sciences, Political Science, Travel and Tourism)	All University and their affiliated Colleges and Self financing Colleges in India and Abroad.	Government Job and Private Company BPO, Geologist, Journalist
<b>LAW</b>		
LLB B.A+LLB B.Com BBM+LLB BBA+LLB	All University and their affiliated Colleges and Self financing Colleges in India and Abroad.	Lawyer, Legal Officer, Govt Job
CA	The Institute of Chartered Accountant of India (ICAI)	CA Private and Govt.
Diploma	Government Polytechnic and Self-financing colleges	Junior Engineer (Government and Private)
<b>Commerce Courses</b>		
B.com-Regular, B.com-Taxation & Tax Procedure, B.com-Travel &Tourism, B.com-Bank Management, B.com-Professional, BBA/BBM-Regular, BFM- Bachelors in Financial Markets, BMS-Bachelors in Management Studies, BAF- Bachelors in Accounting & Finance, Certified Stock Broker & Investment Analysis, Certified Financial Analyst, Certified Financial Planner, Certified Investment Banker	All University and their affiliated Colleges and Self financing Colleges in India and Abroad.	Private Organization , Government ,Banking sectors and prospects for self – employment.

COURSES	COLLEGES/ UNIVERSITIES	PROFESSION
<b>Management Courses</b>		
Business Management Bank Management Event Management Hospital Management Human Resource Management Logistics Management	All University and their affiliated Colleges and Self financing Colleges in India and Abroad.	Private Organization , Government ,Banking sectors and prospects for self – employment.
<b>LAW</b>		
LLB B.A+LLB B.Com BBM+LLB BBA+LLB	All University and their affiliated Colleges and Self financing Colleges in India and Abroad.	Lawyer, Legal Officer, Private Organization , Government, Banking sectors and prospects for self – employment
CA-Chartered Accountant CMA-Cost Management Accountant. CS-Company Secretary (Foundation)	The Institute of Chartered Accountant of India (ICAI)	CA, Private Organization, Government ,Banking sectors and prospects for self – employment.
<b>Science and Humanities</b>		
B.Sc.Botany B.Sc.Zoology B.Sc.Dietician & Nutritionist B.Sc.Home Science B.Sc.Food Technology B.Sc.Dairy Technology B.Sc. Hotel Management B.Sc. Fashion Design B.Sc. Mass Communication B.Sc. Multimedia B.Sc. -3D Animation	All University and their affiliated Colleges and Self financing Colleges in India and Abroad	Government Job and Private Company BPO, Geologist, Journalist
<b>LAW</b>		
LLB B.A+LLB B.Com BBM+LLB BBA+LLB	All University and their affiliated Colleges and Self financing Colleges in India and Abroad.	Lawyer, Legal Officer, Govt Job
CA	The Institute of Chartered Accountant of India (ICAI)	CA Private and Govt.
Diploma	Government Polytechnic and Self-financing colleges	Junior Engineer (Government and Private)

# Table of Contents

Chapter No.	Title	Page No	Month
<b>UNIT I – FUNDAMENTALS OF COMPUTER AND WORKING WITH A TYPICAL OPERATING SYSTEMS (WINDOWS &amp; LINUX)</b>			
1	<b>Introduction to Computers</b>	1	June
2	<b>Number Systems</b>	14	June
3	<b>Computer Organisation</b>	32	June
4	<b>Theoretical Concepts of Operating System</b>	41	July
5	<b>Working with Windows Operating System</b>	48	July
<b>UNIT II-OFFICE AUTOMATION TOOLS (WORD PROCESSOR, SPREADSHEET AND PRESENTATION)</b>			
6	<b>Introduction to Word Processor</b>	67	July
7	<b>Working with OpenOffice Calc</b>	102	August
8	<b>Presentation Basics</b>	170	August
<b>UNIT III – WEB PAGE DEVELOPMENT USING HTML AND CSS</b>			
9	<b>Introduction to Internet and Email</b>	202	September
10	<b>HTML - Structural Tags</b>	219	September
11	<b>HTML - Formatting text, Creating Tables, List and Links</b>	238	October
12	<b>HTML - Adding multimedia elements and Forms</b>	268	October
13	<b>CSS - Cascading Style Sheets</b>	286	October
<b>UNIT IV – JAVASCRIPT</b>			
14	<b>Introduction to Javascript</b>	294	November
15	<b>Control Structure in Javascript</b>	315	November
16	<b>JavaScript Functions</b>	331	November
<b>UNIT V – COMPUTER ETHICS AND CYBER SECURITY</b>			
17	<b>Computer Ethics and Cyber Security</b>	337	December
<b>UNIT VI – TAMIL COMPUTING</b>			
18	<b>Tamil Computing</b>	343	December
	<b>Practical</b>	349	



E - book



Assessment

## Learning Objectives

After learning the concepts in this chapter, the students will be able

- To know about Computers
- To learn about various generations of computer
- To understand the basic operations of computers
- To know the components and their functions.
- To know about booting of a computer



**DO YOU KNOW?**

### Father of Computer

Charles Babbage is considered to be the father of computer, for his invention and the concept of Analytical Engine in 1837. The Analytical Engine contained an Arithmetic Logic Unit (ALU), basic flow control, and integrated memory; which led to the development of first general-purpose computer concept.





## Introduction to Computers

### 1.1 Introduction to Computers

Computers are seen everywhere around us, in all spheres of life, in the field of education, research, travel and tourism, weather forecasting, social networking, e-commerce etc. Computers have now become an indispensable part of our lives. Computers have revolutionised our lives with their accuracy and speed of performing a job, it is truly remarkable. Today, no organisation can function without a computer. In fact, various organisations have become paperless. Computers have evolved over the years from a simple calculating device to high speed portable computers.





The growth of computer industry started with the need for performing fast calculations. The manual method of computing was slow and prone to errors. So, attempts were made to develop fast calculating devices, the journey started from the first known calculating device (Abacus) which has led us today to an extremely high speed calculating devices.

### 1.2 Generations of Computers

Growth in the computer industry is determined by the development in technology.

Based on various stages of development, computers can be categorised into different generations.

SN	Generation	Period	Main Component used	Merits/Demerits
1	<b>First Generation</b>	1940-1956	 <b>Vacuum tubes</b>	<ul style="list-style-type: none"> <li>• Big in size</li> <li>• Consumed more power</li> <li>• Malfunction due to overheat</li> <li>• Machine Language was used</li> </ul>

First Generation Computers - ENIAC , EDVAC , UNIVAC 1 ENIAC weighed about 27 tons, size 8 feet × 100 feet × 3 feet and consumed around 150 watts of power				
2	<b>Second Generation</b>	1956-1964	 <p><b>Transistors</b></p>	<ul style="list-style-type: none"> <li>• Smaller compared to First Generation</li> <li>• Generated Less Heat</li> <li>• Consumed less power compared to first generation</li> <li>• Punched cards were used</li> <li>• First operating system was developed - Batch Processing and Multiprogramming Operating System</li> <li>• Machine language as well as Assembly language was used.</li> </ul>
Second Generation Computers IBM 1401, IBM 1620, UNIVAC 1108				
3	<b>Third Generation</b>	1964-1971	 <p><b>Integrated Circuits (IC)</b></p>	<ul style="list-style-type: none"> <li>• Computers were smaller, faster and more reliable</li> <li>• Consumed less power</li> <li>• High Level Languages were used</li> </ul>
Third Generation Computers IBM 360 series, Honeywell 6000 series				
4	<b>Fourth Generation</b>	1971-1980	 <p><b>Microprocessor</b> Very Large Scale Integrated Circuits (VLSI)</p>	<ul style="list-style-type: none"> <li>• Smaller and Faster</li> <li>• Microcomputer series such as IBM and APPLE were developed</li> <li>• Portable Computers were introduced.</li> </ul>
5	<b>Fifth Generation</b>	1980 - till date	 <p><b>Ultra Large Scale Integration (ULSI)</b></p>	<ul style="list-style-type: none"> <li>• Parallel Processing</li> <li>• Super conductors</li> <li>• Computers size was drastically reduced.</li> <li>• Can recognise Images and Graphics</li> <li>• Introduction of Artificial Intelligence and Expert Systems</li> <li>• Able to solve high complex problems including decision making and logical reasoning</li> </ul>



6	<b>Sixth Generation</b>	In future		<ul style="list-style-type: none"> <li>• Parallel and Distributed computing</li> <li>• Computers have become smarter, faster and smaller</li> <li>• Development of robotics</li> <li>• Natural Language Processing</li> <li>• Development of Voice Recognition Software</li> </ul>
---	-------------------------	-----------	---	--

Table1.1 Generations of computers

**DO YOU KNOW?** **The first digital computer**

The ENIAC (Electronic Numerical Integrator And Calculator) was invented by J. Presper Eckert and John Mauchly at the University of Pennsylvania and began construction in 1943 and was not completed until 1946. It occupied about 1,800 square feet and used about 18,000 vacuum tubes, weighing almost 50 tons. ENIAC was the first digital computer because it was fully functional.





### 1.3 Sixth Generation Computing

In the Sixth Generation, computers could be defined as the era of intelligent computers, based on Artificial Neural Networks. One of the most dramatic changes in the sixth generation will be the explosive growth of Wide Area Networking. Natural Language Processing (NLP) is a component of Artificial Intelligence (AI). It provides the ability to develop the computer program to understand human language.

**DO YOU KNOW?** **Optical Character Recognition (Optical Grapheme Recognition) engine for the Indus Scripts has been developed using Deep Learning Neural Networks (a sub-field of Artificial Intelligence).**

Given photographs, scans, or any image feed of an Indus Valley Civilization artifact, the system will be able to recognise the inscriptions (the symbol/grapheme sequences) from the image. There are totally 417 Symbols/Graphemes/Characters in the Indus Scripts and just 3700+ text inscriptions of data for the machine to learn and attain expert-level status.

### 1.4. Data and Information

We all know what a computer is? It is an electronic device that processes the input according to the set of instructions provided to it and gives the desired output

at a very fast rate. Computers are very versatile as they do a lot of different tasks such as storing data, weather forecasting, booking airlines, railway or movie tickets and even playing games.

**Data:** Data is defined as an unprocessed collection of raw facts, suitable for communication, interpretation or processing.

For example, 134, 16 'Kavitha', 'C' are data. This will not give any meaningful message.

**Information:** Information is a collection of facts from which conclusions may be drawn. In simple words we can say that data is the raw facts that is processed to give meaningful, ordered or structured information. For example Kavitha is 16 years old. This information is about Kavitha and conveys some meaning. This conversion of data into information is called data processing.

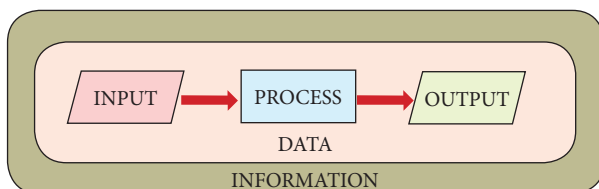

Figure 1.1 Data and Information

“A Computer is an electronic device that takes raw data (unprocessed) as an input from the user and processes it under the control of a set of instructions (called program), produces a result (output), and saves it for future use.”

## 1.5 Components of a Computer

The computer is the combination of hardware and software. Hardware is the physical component of a computer like motherboard, memory devices, monitor, keyboard etc., while software is the set of

programs or instructions. Both hardware and software together make the computer system to function.



Figure 1.2: Computer

Let us first have a look at the functional components of a computer. Every task given to a computer follows an Input- Process- Output Cycle (IPO cycle). It needs certain input, processes that input and produces the desired output. The input unit takes the input, the central processing unit does the processing of data and the output unit produces the output. The memory unit holds the data and instructions during the processing.

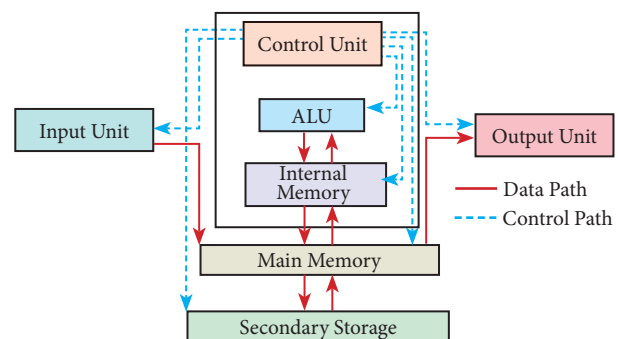

Figure 1.3 components of a computer

### 1.5.1 Input Unit

Input unit is used to feed any form of data to the computer, which can be stored in the memory unit for further processing. Example: Keyboard, mouse, etc.



### 1.5.2 Central Processing Unit

CPU is the major component which interprets and executes software instructions. It also control the operation of all other components such as memory, input and output units. It accepts binary data as input, process the data according to the instructions and provide the result as output.

The CPU has three components which are Control unit, Arithmetic and logic unit (ALU) and Memory unit.

#### 1.5.2.1 Arithmetic and Logic Unit

The ALU is a part of the CPU where various computing functions are performed on data. The ALU performs arithmetic operations such as addition, subtraction, multiplication, division and logical operations. The result of an operation is stored in internal memory of CPU. The logical operations of ALU promote the decision-making ability of a computer.

#### 1.5.2.2 Control Unit

The control unit controls the flow of data between the CPU, memory and I/O devices. It also controls the entire operation of a computer.

### 1.5.3. Output Unit

An Output Unit is any hardware component that conveys information to users in an understandable form. Example: Monitor, Printer etc.

### 1.5.4. Memory Unit

The Memory Unit is of two types which are primary memory and secondary memory. The primary memory is used

to temporarily store the programs and data when the instructions are ready to execute. The secondary memory is used to store the data permanently.

The Primary Memory is volatile, that is, the content is lost when the power supply is switched off. The Random Access Memory (RAM) is an example of a main memory. The Secondary memory is non volatile, that is, the content is available even after the power supply is switched off. Hard disk, CD-ROM and DVD ROM are examples of secondary memory.

### 1.5.5. Input and Output Devices

#### Input Devices:

(1) **Keyboard:** Keyboard (wired / wireless, virtual) is the most common input device used today. The individual keys for letters, numbers and special characters are collectively known as character keys. This keyboard layout is derived from the keyboard of original typewriter. The data and instructions are given as input to the computer by typing on the keyboard. Apart from alphabet and numeric keys, it also has Function keys for performing different functions. There are different set of keys available in the keyboard such as character keys, modifier keys, system and GUI keys, enter and editing keys, function keys, navigation keys, numeric keypad and lock keys.



Figure 1.4 Keyboard

(2) **Mouse:** Mouse (wired/wireless) is a pointing device used to control the





movement of the cursor on the display screen. It can be used to select icons, menus, command buttons or activate something on a computer. Some mouse actions are move, click, double click, right click, drag and drop.

Different types of mouse available are: Mechanical Mouse, Optical, Laser Mouse, Air Mouse, 3D Mouse, Tactile Mouse, Ergonomic Mouse and Gaming Mouse.

**DO YOU KNOW?**

**Who invented Mouse?**

The computer mouse as we know it today was invented and developed by Douglas Engelbart, with the assistance of Bill English, during the 1960's and was patented on November 17, 1970.

(3) **Scanner:** Scanners are used to enter the information directly into the computer's memory. This device works like a Xerox machine. The scanner converts any type of printed or written information including photographs into a digital format, which can be manipulated by the computer.



Figure 1.5 Scanner

(4) **Fingerprint Scanner:** Fingerprint Scanner is a fingerprint recognition device used for computer security, equipped with the fingerprint recognition feature that uses biometric technology.

Fingerprint Reader / Scanner is a very safe and convenient device for security instead of using passwords, which is vulnerable to fraud and is hard to remember.



Figure 1.6 Fingerprint Scanner

(5) **Track Ball:** Track ball is similar to the upside-down design of the mouse. The user moves the ball directly, while the device itself remains stationary. The user spins the ball in various directions to navigate the screen movements.



Figure 1.7 Track Ball

(6) **Retinal Scanner:** This performs a retinal scan which is a biometric technique that uses unique patterns on a person's retinal blood vessels.



Figure 1.8 Retinal Scanner

(7) **Light Pen:** A light pen is a pointing device shaped like a pen and is connected to a monitor. The tip of the light pen contains a light-sensitive element which detects the light from the screen enabling the computer to identify the location of the pen on the screen. Light pens



Figure 1.9 Light Pen



have the advantage of 'drawing' directly onto the screen, but this becomes hard to use, and is also not accurate.

**(8) Optical Character Reader:** It is a device which detects characters printed or written on a paper with OCR, a user can scan a page from a book. The Computer will recognise the characters in the page as letters and punctuation marks and stores. The Scanned document can be edited using a wordprocessor.



Figure 1.10 Optical Character Reader

**(9) Bar Code / QR Code Reader:** A Bar code is a pattern printed in lines of different thickness. The Bar code reader scans the information on the bar codes transmits to the Computer for further processing. The system gives fast and error free entry of information into the computer.

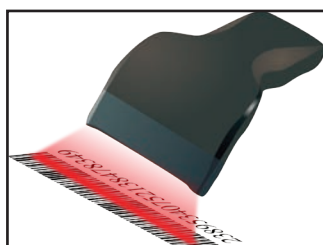

Figure 1.11 Bar code Reader

**QR (Quick response) Code:** The QR code is the two dimension bar code which can be read by a camera and processed to interpret the image.

**(10) Voice Input Systems:** Microphone serves as a voice Input device. It captures the voice data and send it to the Computer. Using the microphone along with speech recognition software can offer a completely



Figure 1.12 Voice input System

new approach to input information into the Computer.

**(11) Digital Camera:** It captures images / videos directly in the digital form. It uses a CCD (Charge Coupled Device) electronic chip. When light falls on the chip through the lens, it converts light rays into digital format.



Figure 1.13 Digital Camera

**(12) Touch Screen:** A touch screen is a display device that allows the user to interact with a computer by using the finger. It can be quite useful as an alternative to a mouse or keyboard for navigating a Graphical User Interface (GUI). Touch screens are used on a wide variety of devices such as computers, laptops, monitors, smart phones, tablets, cash registers and information kiosks. Some touch screens



Figure 1.14 Touch Screen

use a grid of infrared beams to sense the presence of a finger instead of utilizing touch-sensitive input.

**(13) Keyer :** A Keyer is a device for signaling by hand, by way of pressing one or more switches. Modern keyers have a large number of switches but not as many as a full size keyboard.

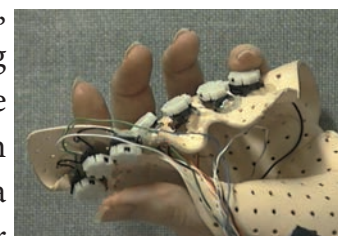

Figure 1.15 Keyer



Typically, this number is between 4 and 50. A keyer differs from a keyboard, which has "no board", but the keys are arranged in a cluster.

### Output Devices:

(1) **Monitor:** Monitor is the most commonly used output device to display the information. It looks like a TV. Pictures on a monitor are formed with picture elements called PIXELS. Monitors may either be Monochrome



which display text or images in Black and White or can be color, which display results in multiple colors. There are many types of monitors available such as CRT (Cathode Ray Tube), LCD (Liquid Crystal Display) and LED (Light Emitting Diodes). The monitor works with the VGA (Video Graphics Array) card. The video graphics card helps the keyboard to communicate with the screen. It acts as an interface between the computer and display monitor. Usually the recent motherboards incorporate built-in video card.

The first computer monitor was part of the Xerox Alto computer system, which was released on March 1, 1973.

(2) **Plotter:** Plotter is an output device that is used to produce graphical output on papers. It uses single color or multi color pens to draw pictures.



Figure 1.17 Plotter

(3) **Printers:** Printers are used to print the information on papers. Printers are divided into two main categories:

- Impact Printers
- Non Impact printers

### Impact Printers

These printers print with striking of hammers or pins on ribbon. These printers can print on multi-part (using carbon papers) by using mechanical pressure.



For example, Dot Matrix Printer

Matrix printers and Line matrix printers are impact printers.

A Dot matrix printer that prints using a fixed number of pins or wires. Each dot is produced by a tiny metal rod, also called a "wire" or "pin", which works by the power of a tiny electromagnet or solenoid, either directly or through a set of small levers. It generally prints one line of text at a time. The printing speed of these printers varies from 30 to 1550 CPS (Character Per Second).

Line matrix printers use a fixed print head for printing. Basically, it prints a page-wide line of dots. But it builds up a line of text by printing lines of dots. Line



printers are capable of printing much more than 1000 Lines Per Minute, resulting in thousands of pages per hour. These printers also uses mechanical pressure to print on multi-part (using carbon papers).

### Non-Impact Printers

These printers do not use striking mechanism for printing. They use electrostatic or laser technology. Quality and speed of these printers are better than Impact printers. For example, Laser printers and Inkjet printers are non-impact printers.

### Laser Printers

Laser printers mostly work with similar technology used by photocopiers. It makes a laser beam scan back and forth across a drum inside the printer, building up a pattern. It can produce very good quality of graphic images. One of the chief characteristics of laser printer is their resolution – how many Dots per inch(DPI). The available resolution range around 1200 dpi. Approximately it can print 100 pages per minute(PPM)



Figure 1.19 Laser Printer

### Inkjet Printers:

Inkjet Printers use colour cartridges which combined Magenta, Yellow and Cyan inks to create color tones. A black cartridge is also used for monochrome output. Inkjet printers work by spraying ionised ink at a sheet of paper. The speed of Inkjet printers generally range from 1-20 PPM (Page Per Minute).



Figure 1.20 Inkjet Printer

They use the technology of firing ink by heating it so that it explodes towards the paper in bubbles or by using piezoelectricity in which tiny electric currents controlled by electronic circuits are used inside the printer to spread ink in jet speed. An Inkjet printer can spread millions of dots of ink at the paper every single second.

**Speakers:** Speakers produce voice output (audio) . Using speaker along with speech synthesise



software, the computer can provide voice output. This has become very common in places like airlines, schools, banks, railway stations, etc.

### Multimedia Projectors:

Multimedia projectors are used to produce computer output on a big screen. These are used to display presentations in meeting halls or in classrooms.



Figure 1.22 Multimedia Projector



## 1.6 Booting of computer

An Operating system (OS) is a basic software that makes the computer to work. When a computer is switched on, there is no information in its RAM. At the same time, in ROM, the pre-written program called POST (Power on Self Test) will be executed first. This program checks if the devices like RAM, keyboard, etc., are connected properly and ready to operate. If these devices are ready, then the BIOS (Basic Input Output System) gets executed. This process is called Booting. Thereafter, a program called “Bootstrap Loader” transfers OS from hard disk into main memory. Now the OS gets loaded (Windows/Linux, etc.,) and will get executed. Booting process is of two types.

- 1) Cold Booting
- 2) Warm Booting

**Cold Booting:** When the system starts from initial state i.e. it is switched on, we call it cold booting or Hard Booting. When the user presses the Power button, the instructions are read from the ROM to initiate the booting process.

**Warm Booting:** When the system restarts or when Reset button is pressed, we call it Warm Booting or Soft Booting. The system does not start from initial state and so all diagnostic tests need not be carried out in this case. There are chances of data loss and system damage as the data might not have been stored properly.

## Points to Remember:

- Computers are seen everywhere around us, in all spheres of life.
- It is an electronic device that processes the input according to the set of instructions provided to it and gives the desired output at a very fast rate.
- Based on various stages of development, computers can be divided into six different generations.
- The computer is the combination of hardware and software.
- Hardware is the physical component of a computer.
- Input unit is used to feed any form of data to the computer.
- CPU interprets and executes software instructions.
- The ALU is a part of the CPU where various computing functions are performed on data.
- The control unit controls the flow of data between the CPU, memory and I/O devices.
- An Output Unit is any hardware component that conveys information to one or more people in user understandable form.
- The Memory Unit is of two kinds which are primary memory and secondary memory.

### Activity



### STUDENT ACTIVITY

1. Explain the classification of computers.
2. Give the details of motherboard names, RAM capacity used in the years 1993, 1995, 2005, 2008, 2016.
3. Mention two new input and output devices that are not given in this chapter.



## Evaluation



### PART - I

Choose the correct answer:

1. First generation computers used
  - (a) Vacuum tubes
  - (b) Transistors
  - (c) Integrated circuits
  - (d) Microprocessors
2. Name the volatile memory
  - (a) ROM
  - (b) PROM
  - (c) RAM
  - (d) EPROM
3. Identify the output device
  - (a) Keyboard
  - (b) Memory
  - (c) Monitor
  - (d) Mouse
4. Identify the input device
  - (a) Printer
  - (b) Mouse
  - (c) Plotter
  - (d) Projector
5. .... Output device is used for printing building plan.
  - (a) Thermal printer
  - (b) Plotter
  - (c) Dot matrix
  - (d) inkjet printer
6. Which one of the following is used to in ATM machines
  - (a) Touch Screen
  - (b) speaker
  - (c) Monitor
  - (d) Printer
7. When a system restarts which type of booting is used.
  - (a) Warm booting
  - (b) Cold booting
  - (c) Touch boot
  - (d) Real boot.



8. Expand POST
  - (a) Post on self Test
  - (b) Power on Software Test
  - (c) Power on Self Test
  - (d) Power on Self Text
9. Which one of the following is the main memory?
  - (a) ROM
  - (b) RAM
  - (c) Flash drive
  - (d) Hard disk
10. Which generation of computer used IC's?
  - (a) First
  - (b) Second
  - (c) Third
  - (d) Fourth

### PART - II

Very Short Answers

1. What is a computer?
2. Distinguish between data and information.
3. What are the components of a CPU?
4. What is the function of an ALU?
5. Write the functions of control unit.
6. What is the function of memory?
7. Differentiate Input and output unit.
8. Distinguish Primary and Secondary memory.

### PART - III

Short Answers

1. What are the characteristics of a computer?
2. Write the applications of computer.
3. What is an input device? Give two examples.
4. Name any three output devices.
5. Differentiate optical and Laser mouse
6. Write shortnote on impact printer
7. Write the characteristics of sixth generation.
8. Write the significant features of monitor.



## PART - IV

### Explain in detail

1. Explain the basic components of a computer with a neat diagram.
2. Discuss the various generations of computers.
3. Explain the following
  - a. Inkjet Printer
  - b. Multimedia projector
  - c. Bar code / QR code Reader

### References

- (1) Fundamentals of Computers – V. Rajaraman – PHI Publications
- (2) Computer Science text book – NCERT, New Delhi



### Internet Resources

- (1) [www.wikipedia.org](http://www.wikipedia.org)
- (2) <https://www.computerhope.com/jargon/c/computer.html>



Prepare a comparative study of various computers of past and present with respect to speed, memory, size, power consumption and other features

<b>Computer</b>	It is an electronic device that processes the input according to the set of instructions provided to it and gives the desired output at a very fast rate.
<b>Vacuum tube</b>	Vacuum tubes contain electrodes for controlling electron flow and were used in early computers as a switch or an amplifier.
<b>Transistors</b>	The transistor ("transfer resistance") is made up of semi-conductors. It is a component used to control the amount of current or voltage used for amplification/modulation of an electronic signal.
<b>Punched cards</b>	Punch cards also known as Hollerith cards are paper cards containing several punched or perforated holes that were punched by hand or machine to represent data.
<b>Machine Language</b>	Machine language is a collection of binary digits or bits that the computer reads and interprets.
<b>Assembly language</b>	An assembly language is a low-level programming language.

<b>Integrated Circuits</b>	The IC is a package containing many circuits, pathways, transistors, and other electronic components all working together to perform a particular function or a series of functions.
<b>Microcomputer</b>	Micro computer is used to describe a standard personal computer.
<b>High-level languages</b>	A high-level language is a computer programming language that isn't limited by the computer, designed for a specific job, and is easier to understand.
<b>Natural Language Processing (NLP)</b>	Natural Language Processing is a method used in artificial intelligence to process and derive meaning from the human language.
<b>Robotics</b>	Robot is a term coined by Karel Capek in the 1921 to play RUR (Rossum's Universal Robots). It is used to describe a computerized machine designed to respond to input received manually or from its surroundings.
<b>Nanotechnology</b>	Nanotechnology is an engineering, science, and technology that develops machines or works with one atom or one molecule that is 100 nanometers or smaller.
<b>Bioengineering</b>	A discipline that applies engineering principles of design and analysis to biological systems and biomedical technologies

### Learning Objectives

- To know how the computer interprets and stores data in the memory.
- To learn various data representations and binary arithmetic.
- To learn conversion between various Number Systems.

### 2.1 Introduction

The term data comes from the word **datum**, which means a raw fact. The data is a fact about people, places or some objects.

#### Example:

Let 'Name', 'Age', 'Class', 'Marks' and 'Subject' be some defined variables. Now, let us assign a value to each of these variables.

Name	=	Rajesh
Age	=	16
Class	=	XI
Mark	=	65
Subject	=	Computer Science

Figure 2.1 Example for Data

In the above example, the values assigned to the five different variables are called **data**. When the above data is processed, we get an information "Rajesh is 16 years old, studying in Class XI, has scored 65 marks in Computer Science subject".

## Number Systems

### 2.2 Data Representations

Computer handles data in the form of '0' (Zero) and '1' (One). Any kind of data like number, alphabet, special character should be converted to '0' or '1' which can be understood by the Computer. '0' and '1' that the Computer can understand is called **Machine language**. '0' or '1' are called '**Binary Digits**' (BIT). Therefore, the study of data representation in the computer is important.

- A **bit** is the short form of **Binary digit** which can be '0' or '1'. It is the basic unit of data in computers.
- A **nibble** is a collection of 4 bits (Binary digits).
- A collection of 8 bits is called **Byte**. A byte is considered as the basic unit of measuring the memory size in the computer.
- **Word length** refers to the number of bits processed by a Computer's CPU. For example, a word length can have 8 bits, 16 bits, 32 bits and 64 bits (Present day Computers use 32 bits or 64 bits)

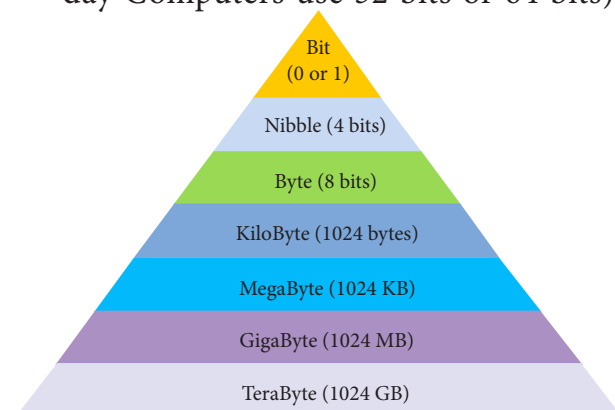

Figure 2.2 Data Representation

**Computer memory** (Main Memory and Secondary Storage) is normally represented in terms of KiloByte (KB) or MegaByte (MB). In decimal system, 1 Kilo

represents 1000, that is,  $10^3$ . In binary system, 1 KiloByte represents 1024 bytes that is  $2^{10}$ . The following table represents the various memory sizes:

Table 2.1 Memory Size (Read  $2^{10}$  as 2 power 10)



Name	Abbr.	Size
Kilo	K	$2^{10} = 1,024$
Mega	M	$2^{20} = 1,048,576$
Giga	G	$2^{30} = 1,073,741,824$
Tera	T	$2^{40} = 1,099,511,627,776$
Peta	P	$2^{50} = 1,125,899,906,842,624$
Exa	E	$2^{60} = 1,152,921,504,606,846,976$
Zetta	Z	$2^{70} = 1,180,591,620,717,411,303,424$
Yotta	Y	$2^{80} = 1,208,925,819,614,629,174,706,173$

Bytes are used to represent characters in a text. Different types of coding schemes are used to represent the character set and numbers. The most commonly used coding scheme is the **American Standard Code for Information Interchange** (ASCII). Each binary value between 0 and 127 is used to represent a specific character. The ASCII value for (blank space) is 32 and the ASCII value of numeric 0 is 48. The range of ASCII values for lower case alphabets is from 97 to 122 and the range of ASCII values for the upper case alphabets is 65 to 90.



The speed of a computer depends on the number of bits it can process at once. For example, a 64-bit computer can process 64-bit numbers in one operation, while a 32-bit computer break 64-bit numbers down into smaller pieces, making it slower.

### 2.3 Different Types of Number Systems

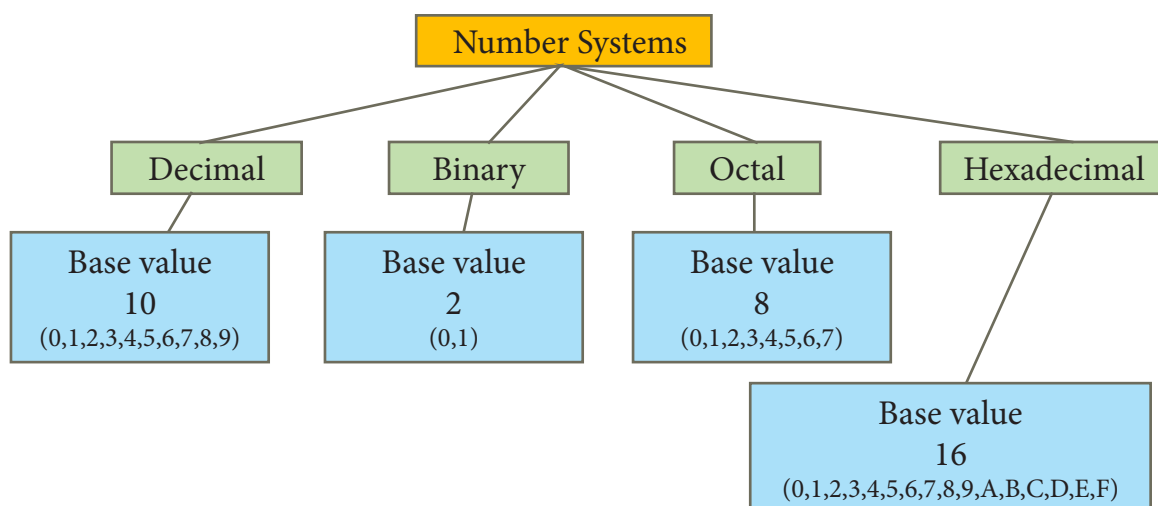

Figure 2.3. Number Systems

A numbering system is a way of representing numbers. The most commonly used numbering system in real life is Decimal number system. Other number systems are Binary, Octal, Hexadecimal number system. Each number system is uniquely identified by its **base value** or **radix**. Radix or base is the count of number of digits in each number system. Radix or base is the general idea behind positional numbering system.

### 2.3.1 Decimal Number System

It consists of 0,1,2,3,4,5,6,7,8,9(10 digits). It is the oldest and most popular number system used in our day to day life. In the positional number system, each decimal digit is weighed relative to its position in the number. This means that each digit in the number is multiplied by 10 raised to a power corresponding to that digit's position.

#### Example

$$\begin{aligned}(123)_{10} &= 1 \times 10^2 + 2 \times 10^1 + 3 \times 10^0 \\ &= 100 + 20 + 3 \\ &= (123)_{10}\end{aligned}$$

### 2.3.2 Binary Number System

There are only two digits in the Binary system, namely, 0 and 1. The numbers in the binary system are represented to the base 2 and the positional multipliers are the powers of 2. The left most bit in the binary number is called as the **Most Significant Bit (MSB)** and it has the largest positional weight. The right most bit is the **Least Significant Bit (LSB)** and has the smallest positional weight.

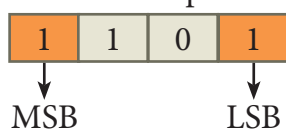

### Example

The binary sequence  $(1101)_2$  has the decimal equivalent:

$$\begin{aligned}(1101)_2 &= 1 \times 2^3 + 1 \times 2^2 + 0 \times 2^1 + 1 \times 2^0 \\ &= 8 + 4 + 0 + 1 \\ &= (13)_{10}\end{aligned}$$

### 2.3.3 Octal Number System

Octal number system uses digits 0,1,2,3,4,5,6 and 7 (8 digits). Each octal digit has its own positional value or weight as a power of 8.

#### Example

The Octal sequence  $(547)_8$  has the decimal equivalent:

$$\begin{aligned}(547)_8 &= 5 \times 8^2 + 4 \times 8^1 + 7 \times 8^0 \\ &= 5 \times 64 + 4 \times 8 + 7 \times 1 \\ &= 320 + 32 + 7 \\ &= (359)_{10}\end{aligned}$$

### 2.3.4 Hexadecimal Number System

A hexadecimal number is represented using base 16. Hexadecimal or Hex numbers are used as a shorthand form of binary sequence. This system is used to represent data in a more compact manner. Since 16 symbols are used, 0 to F, the notation is called hexadecimal. The first 10 symbols are the same as in the decimal system, 0 to 9 and the remaining 6 symbols are taken from the first 6 letters of the alphabet sequence, A to F, where A represents 10, B is 11, C is 12, D is 13, E is 14 and F is 15.

Table 2.2 Binary, Octal, Hexadecimal equivalent of Decimal Numbers

Decimal	Binary	Octal	Hexadecimal
0	0000	000	0000
1	0001	001	0001
2	0010	002	0002
3	0011	003	0003
4	0100	004	0004
5	0101	005	0005
6	0110	006	0006
7	0111	007	0007
8	1000	010	0008
9	1001	011	0009
10	1010	012	A
11	1011	013	B
12	1100	014	C
13	1101	015	D
14	1110	016	E
15	1111	017	F

**Example**

The hexadecimal sequence  $(25)_{16}$  has the decimal equivalent:

$$\begin{aligned}(25)_{16} &= 2 \times 16^1 + 5 \times 16^0 \\ &= 32 + 5 \\ &= (37)_{10}\end{aligned}$$

**Workshop**

1. Identify the number system for the following numbers

S. No.	Number	Number system
1	$(1010)_{10}$	Decimal Number system
2	$(1010)_2$	
3	$(989)_{16}$	
4	$(750)_8$	
5	$(926)_{10}$	

2. State whether the following numbers are valid or not. If invalid, give reason.

S.No.	Statement	Yes / No	Reason (If invalid)
1.	786 is an Octal number		
2.	101 is a Binary number		
3.	Radix of Octal number is 7		

**2.4 Number System Conversions****2.4.1 Decimal to Binary Conversion**

Generally two methods followed.

**Method 1:** To convert Decimal to Binary “Repeated Division by 2” method can be used. Any Decimal number divided by 2 will leave a remainder of 0 or 1. Repeated division by 2 will leave a sequence of 0s and 1s that become the binary equivalent of the decimal number. Suppose it is required to convert the decimal number N into binary form, dividing N by 2 in the

decimal system, we will obtain a quotient N1 and a remainder R1, where R1 can have a value of either 0 or 1. The process is repeated until the quotient becomes 0 or 1. When the quotient is ‘0’ or ‘1’, it is the final remainder value. Write the final answer starting from final remainder value obtained to the first remainder value obtained.

**Example**

Convert  $(65)_{10}$  into its equivalent binary number

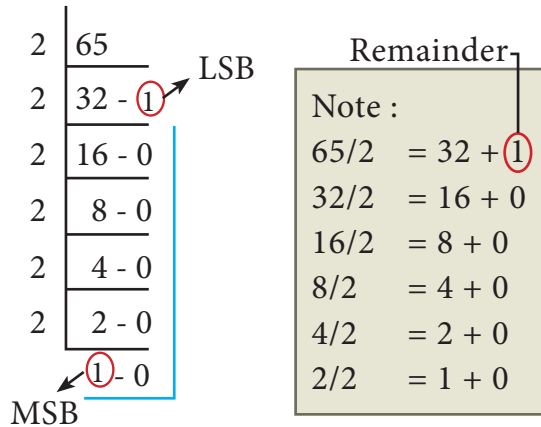

Remainder	
Note :	
65/2	= 32 + 1
32/2	= 16 + 0
16/2	= 8 + 0
8/2	= 4 + 0
4/2	= 2 + 0
2/2	= 1 + 0

**Method 2 : Sum of Powers of 2.**

A decimal number can be converted into a binary number by adding up the powers of 2 and then adding bits as needed to obtain the total value of the number.

- a) Find the largest power of 2 that is smaller than or equal to 65.

$$65_{10} > 64_{10}$$

- b) Set the 64's bit to 1 and subtract 64 from the original number

$$65 - 64 = 1$$

- c) 32 is greater than the remaining total. Therefore, set the 32's bit to 0.
- d) 16 is greater than the remaining total. Therefore, set the 16's bit to 0.
- e) 8 is greater than the remaining total. Therefore, set the 8's bit to 0.
- f) 4 is greater than the remaining total. Therefore, set the 4's bit to 0.
- g) 2 is greater than the remaining total. Therefore, set the 2's bit to 0.
- h) As the remaining value is equivalent to 1's bit, set it to 1.

$$1 - 1 = 0$$

Conversion is complete  $65_{10} = (1000001)_2$

**Example**

The conversion steps can be given as follows:

Given Number : 65

Equivalent or value less than power of 2 is : 64

(1)  $65 - 64 = 1$

(2)  $1 - 1 = 0$

Power's of 2	64	32	16	8	4	2	1
Binary Number	1	0	0	0	0	0	1

$$65_{10} = (1000001)_2$$

**2.4.2 Decimal to Octal Conversion**

To convert Decimal to Octal, "Repeated Division by 8" method can be used. The method is the same we have learnt in 2.4.1, but in this method, we have to divide the given number by 8.

**Example**

Convert  $(65)_{10}$  into its equivalent Octal number

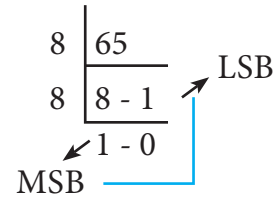

$(65)_{10} = (101)_8$

**2.4.3 Decimal to Hexadecimal Conversion**

To convert Decimal to Hexadecimal, "Repeated division by 16" method can be used. The method is the same as we have learnt in 2.4.1, but in this method, we have to divide the given number by 16.

**Example**

Convert  $(31)_{10}$  into its equivalent hexadecimal number.

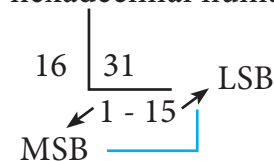

$(31)_{10} = (1F)_{16}$  (Refer Table 2.2 F=15)



### 2.4.4 Conversion of fractional Decimal to Binary

The method of **repeated multiplication by 2** has to be used to convert such kind of decimal fractions.

The steps involved in the method of **repeated multiplication by 2**:

- Step 1: Multiply the decimal fraction by 2 and note the integer part. The integer part is either 0 or 1.
- Step 2: Discard the integer part of the previous product. Multiply the fractional part of the previous product by 2. Repeat Step 1 until the same fraction repeats or terminates (0).
- Step 3: The resulting integer part forms a sequence of 0s and 1s that become the binary equivalent of decimal fraction.
- Step 4: The final answer is to be written from first integer part obtained till the last integer part obtained.

	Integer part
$0.2 \times 2 = 0.4$	0 (first integer part obtained)
$0.4 \times 2 = 0.8$	0
$0.8 \times 2 = 1.6$	1
$0.6 \times 2 = 1.2$	1
$0.2 \times 2 = 0.4$	0 (last integer part obtained)

**Note:** Fraction repeats, the product is the same as in the first step.

Write the integer parts from top to bottom to obtain the equivalent fractional binary number. Hence  $(0.2)_{10} = (0.00110011\dots)_2 = (0.00110011)_2$

### Workshop



3. Convert the following Decimal numbers to its equivalent Binary, Octal, Hexadecimal.

- 1) 1920      2) 255      3) 126

### 2.4.5 Binary to Decimal Conversion

To convert Binary to Decimal we can use positional notation method.

- Step 1: Write down the Binary digits and list the powers of 2 from right to left (Positional Notation)
- Step 2: For each positional notation written for the digit, now write the equivalent weight.
- Step 3: Multiply each digit with its corresponding weight
- Step 4: Add all the values.

Table 2.3 Positional Notation and Weight

Positional Notation	Weight	Positional Notation	Weight
$2^0$	1	$2^6$	64
$2^1$	2	$2^7$	128
$2^2$	4	$2^8$	256
$2^3$	8	$2^9$	512
$2^4$	16	$2^{10}$	1024
$2^5$	32		

### Example

Convert  $(111011)_2$  into its equivalent decimal number.

Weight	32	16	8	4	2	1
Positional Notation	$2^5$	$2^4$	$2^3$	$2^2$	$2^1$	$2^0$
Given number	1	1	1	0	1	1

$$\begin{aligned} 32+16+8+0+2+1 &= (59)_{10} \\ (111011)_2 &= (59)_{10} \end{aligned}$$

#### 2.4.6 Binary to Octal Conversion

Step 1: Group the given binary number into 3 bits from right to left.

Step 2: You can add preceding 0 to make a group of 3 bits if the left most group has less than 3 bits.

Step 3: Convert equivalent octal value using "2's power positional weight method"

Table 2.4 Octal numbers and their Binary equivalent

Octal	Binary Equivalent
0	000
1	001
2	010
3	011
4	100
5	101
6	110
7	111

#### Example

Convert  $(11010110)_2$  into octal equivalent number

Step 1: Group the given number into 3 bits from right to left.

$$011\ 010\ 110$$

Note: The left most groups have less than 3 bits, so 0 is added to its left to make a group of 3 bits.

Step-2: Find Octal equivalent of each group

$$\begin{array}{ccc} 011 & 010 & 110 \\ \underbrace{\hspace{1cm}} & \underbrace{\hspace{1cm}} & \underbrace{\hspace{1cm}} \\ 3 & 2 & 6 \\ (11010110)_2 & = & (326)_8 \end{array}$$

#### 2.4.7. Binary to Hexadecimal Conversion

Step 1: Group the given number into 4 bits from right to left.

Step 2: You can add preceding 0's to make a group of 4 bits if the left most group has less than 4 bits.

Step 3: Convert equivalent Hexadecimal value using "2's power positional weight method"

#### Example

Convert  $(1111010110)_2$  into Hexadecimal number

Step 1: Group the given number into 4 bits from right to left.

$$0011\ 1101\ 0110$$

Note: 0's are added to the left most group to make it a group of 4 bits

$$\begin{array}{ccc} 0011 & 1101 & 0110 \\ \underbrace{\hspace{1cm}} & \underbrace{\hspace{1cm}} & \underbrace{\hspace{1cm}} \\ 3 & D & 6 \\ (1111010110)_2 & = & (3D6)_{16} \end{array}$$

#### 2.4.8 Conversion of fractional Binary to Decimal equivalent

Follow the steps to convert fractional Binary number to its Decimal equivalent.

Step 1: Convert integral part of Binary to Decimal equivalent using positional notation method (Procedure is same as discussed in 2.4.5)

Step 2: To convert the fractional part of binary to its decimal equivalent.

Step 2.1: Write down the Binary digits in the fractional part

Step 2.2: For all the digits write powers of 2 from left to right starting from  $2^{-1}$ ,  $2^{-2}$ ,  $2^{-3}$ ,.....  $2^{-n}$ , now write the equivalent weight.

Step 2.3: Multiply each digit with its corresponding weight

Step 2.4: Add all the values which you obtained in Step 2.3

Table 2.5 Positional notation and weight

Positional notation	Weight
$2^{-1}$ (1/2)	0.5
$2^{-2}$ (1/4)	0.25
$2^{-3}$ (1/8)	0.125
$2^{-4}$ (1/16)	0.0625
$2^{-5}$ (1/32)	0.03125
$2^{-6}$ (1/64)	0.015625
$2^{-7}$ (1/128)	0.0078125

Step 3: To get final answer write the integral part (after conversion), followed by a decimal point(.) and the answer arrived at Step 2.4

**Example**

Convert the given Binary number  $(11.011)_2$  into its decimal equivalent Integer part  $(11)_2 = 3$  (Refer table 2.2)

$2^1$	$2^0$	.	$2^{-1}$	$2^{-2}$	$2^{-3}$
↑	↑		↑	↑	↑
1	1	.	0	1	1

$$3 + .(0 \times 0.5 + 1 \times 0.25 + 1 \times 0.125)$$

$$= 3.375$$

$$(11.011)_2 = (3.375)_{10}$$

**Workshop**

4. Convert the given Binary number into its equivalent Decimal, Octal and Hexadecimal number.

- 1) 101110101    2) 1011010    3) 101011111

**2.4.9. Octal to Decimal Conversion**

To convert Octal to Decimal, we can use positional notation method.

- Write down the Octal digits and list the powers of 8 from right to left (Positional Notation)

- For each positional notation of the digit write the equivalent weight.

- Multiply each digit with its corresponding weight

- Add all the values

**Example**

Convert  $(1265)_8$  to equivalent Decimal number

Weight	512	64	8	1
Positional Notation	$8^3$	$8^2$	$8^1$	$8^0$
Given number	1	2	6	5

$$(1265)_8 = 512 \times 1 + 64 \times 2 + 8 \times 6 + 1 \times 5$$

$$= 512 + 128 + 48 + 5$$

$$(1265)_8 = (693)_{10}$$

**2.4.10 Octal to Binary Conversion**

For each Octal digit in the given number write its 3 digits binary equivalent using positional notation.

**Example**

Convert  $(6213)_8$  to equivalent Binary number

6	2	1	3
↓	↓	↓	↓
110	010	001	011

$(6213)_8 = (110010001011)_2$

**Workshop**

5. Convert the following Octal numbers into Binary numbers.

- (A) 472      (B) 145      (C) 347  
 (D) 6247    (E) 645

### 2.4.11 Hexadecimal to Decimal Conversion

To convert Hexadecimal to Decimal we can use positional notation method.

1. Write down the Hexadecimal digits and list the powers of 16 from right to left (Positional Notation)
2. For each positional notation written for the digit, now write the equivalent weight.
3. Multiply each digit with its corresponding weight
4. Add all the values to get one final value.

#### Example

Convert  $(25F)_{16}$  into its equivalent Decimal number.

Weight	256	16	1
Positional Notation	$16^2$	$16^1$	$16^0$
Given number	2	5	F(15)

$$(25F)_{16} = 2 \times 256 + 5 \times 16 + 15 \times 1$$

$$= 512 + 80 + 15$$

$$(25F)_{16} = (607)_{10}$$

### 2.4.12 Hexadecimal to Binary Conversion

Write 4 bits Binary equivalent for each Hexadecimal digit for the given number using positional notation method.

#### Example

Convert  $(8BC)_{16}$  into equivalent Binary number

8	B	C
↓	↓	↓
1000	1011	1100
$(8BC)_{16} = (100010111100)_2$		

### Workshop

6. Convert the following Hexadecimal numbers to Binary numbers

- (A) A6      (B) BE  
(C) 9BC8    (D) BC9

### 2.5 Binary Representation for Signed Numbers

Computers can handle both positive (unsigned) and negative (signed) numbers. The simplest method to represent negative binary numbers is called **Signed Magnitude**. In signed magnitude method, the left most bit is Most Significant Bit (MSB), is called **sign bit or parity bit**.

The numbers are represented in computers in different ways:

- Signed Magnitude representation
- 1's Complement
- 2's Complement

#### 2.5.1 Signed Magnitude representation

The value of the whole numbers can be determined by the sign used before it. If the number has '+' sign or no sign it will be considered as positive. If the number has '-' sign it will be considered as negative.

#### Example:

+43 or 43 is a positive number

-43 is a negative number

In signed binary representation, the left most bit is considered as sign bit. If this bit is 0, it is a positive number and if it 1, it is a negative number. Therefore a signed binary number has 8 bits, only 7 bits used for storing values (magnitude) and the 1 bit is used for sign.

+43 is represented in memory as follows:

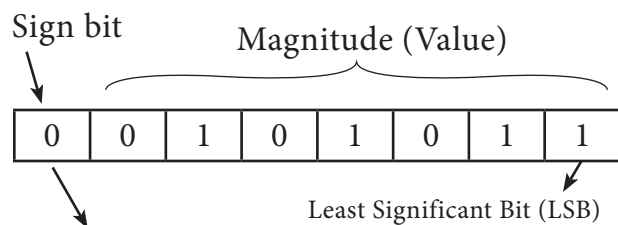

Most Significant Bit (MSB)  
(‘0’ represent that the number is positive)

-43 can be represented in memory as follows.

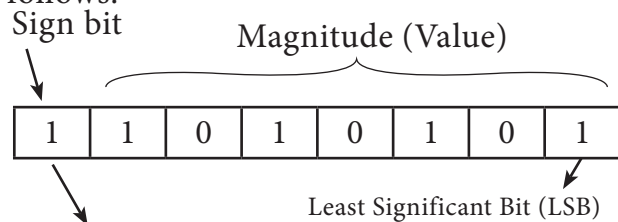

Most Significant Bit (MSB)  
(‘1’ represent that the number is negative)

### 2.5.2 1’s Complement representation

This is an easier approach to represent signed numbers. This is for negative numbers only i.e. the number whose MSB is 1.

The steps to be followed to find 1’s complement of a number:

- Step 1: Convert given Decimal number into Binary
- Step 2: Check if the binary number contains 8 bits , if less add 0 at the left most bit, to make it as 8 bits.
- Step 3: Invert all bits (i.e. Change 1 as 0 and 0 as 1)

#### Example

Find 1’s complement for  $(-24)_{10}$

Given Number	Binary Number	1’s Compliment
$(-24)_{10}$	00011000	11100111

### 2.5.3 2’s Complement representation

The 2’s-complement method for negative number is as follows:

- a. Invert all the bits in the binary sequence (i.e., change every 0 to 1 and every 1 to 0 ie.,1’s complement)
- b. Add 1 to the result to the Least Significant Bit (LSB).

#### Example

2’s Complement represent of  $(-24)_{10}$

Binary equivalent of +24:	11000
8bit format:	00011000
1’s complement:	11100111
Add 1 to LSB:	+1
<b>2’s complement of -24:</b>	<b>11101000</b>

#### Workshop

7. Write the 1’s complement number and 2’s complement number for the following decimal numbers:

- (A) 22 (B) -13 (C) -65 (D) -46

## 2.6 Binary Arithmetic

As decimal numbers, the binary numbers also permit computations like addition, subtraction, multiplication and division. The following session deals only with binary addition and subtraction.

### 2.6.1 Binary Addition

The following table is useful when adding two binary numbers.

A	B	SUM (A + B)	Carry
0	0	0	-
0	1	1	-
1	0	1	-
1	1	0	1

In  $1 + 1 = 10$ , is considered as sum 0 and the 1 as carry bit. This carry bit is added with the previous position of the bit pattern.

**Example Add:**  $1011_2 + 1001_2$   
 (Carry Bit) →

	1	1	1	1	1	}	10
+	1	0	0	0	1		
1	0	1	0	0	0		

$1011_2 + 1001_2 = 10100_2$

**Example** Perform Binary addition for the following:  $23_{10} + 12_{10}$

Step 1: Convert 23 and 12 into binary form

23 <sub>10</sub>					
2's power	16	8	4	2	1
Binary Number	1	0	1	1	1
$23_{10} = 00010111_2$					

12 <sub>10</sub>				
2's power	8	4	2	1
Binary Number	1	1	0	0
$12_{10} = 00001100_2$				

Step 2: Binary addition of 23 and 12:

Carry Bit →	1	1	1				
23 <sub>10</sub> = 0	0	0	1	0	1	1	1
12 <sub>10</sub> = 0	0	0	0	1	1	0	0
35 <sub>10</sub> = 0	0	1	0	0	0	1	1

### 2.6.2 Binary Substraction

The table for Binary Substraction is as follows:

A	B	Difference (A-B)	Borrow
0	0	0	0
1	0	1	0
1	1	0	0
0	1	1	1

When subtracting 1 from 0, borrow 1 from the next Most Significant Bit, when borrowing from the next Most Significant Bit, if it is 1, replace it with 0. If the next Most

Significant Bit is 0, you must borrow from a more significant bit that contains 1 and replace it with 0 and 0s upto that point become 1s.

**Example** Subtract  $1001010_2 - 10100_2$

	0	1	10	0	10	
-	<del>1</del>	<del>0</del>	<del>0</del>	<del>1</del>	0	1
(-)	1	0	1	0	0	
	1	1	0	1	1	0

**Example** Perform binary addition for the following:  $(-21)_{10} + (5)_{10}$

Step 1: Change -21 and 5 into binary form

21 <sub>10</sub>					
2's power	16	8	4	2	1
Binary Number	1	0	1	0	1
$21_{10} = 00010101_2$					

5 <sub>10</sub>			
2's power	4	2	1
Binary Number	1	0	1
$5_{10} = 00000101_2$			

Step 2:

21 <sub>10</sub>	0	0	0	1	0	1	0	1
1's Complement	1	1	1	0	1	0	1	0
2's Complement	1	1	1	0	1	0	1	1

Step 3:

Binary Addition of -21 and 5 :

Carry bit				1	1	1	1	
-21 <sub>10</sub>	1	1	1	0	1	0	1	1
5 <sub>10</sub>	0	0	0	0	0	1	0	1
-16 <sub>10</sub> (Result)	1	1	1	1	0	0	0	0

### Workshop

8. Perform the following binary computations:

- (A)  $10_{10} + 15_{10}$       (B)  $-12_{10} + 5_{10}$   
 (C)  $14_{10} - 12_{10}$       (D)  $(-2_{10}) - (-6_{10})$

## 2.7 Representing Characters in Memory

As represented in introduction, all the input data given to the computer should be in understandable format. In general, 26 uppercase letters, 26 lowercase letters, 0 to 9 digits and special characters are used in a computer, which is called character set. All these character set are denoted through numbers only. All Characters in the character set needs a common encoding system. There are several encoding systems used for computer. They are

- BCD – Binary Coded Decimal
- EBCDIC – Extended Binary Coded Decimal Interchange Code
- ASCII – American Standard Code for Information Interchange
- Unicode
- ISCII - Indian Standard Code for Information Interchange

### 2.7.1 Binary Coded Decimal (BCD)

This encoding system is not in the practice right now. This is  $2^6$  bit encoding system. This can handle  $2^6 = 64$  characters only.

### 2.7.2 American Standard Code for Information Interchange (ASCII)

This is the most popular encoding system recognized by United States. Most of the computers use this system. Remember this encoding system can handle English characters only. This can handle  $2^7$  bit which means 128 characters.

In this system, each character has individual number (Refer **Appendix**).

The new edition (version) ASCII -8, has  $2^8$  bits and can handle 256 characters are represented from 0 to 255 unique numbers.

The ASCII code equivalent to the uppercase letter 'A' is 65. The binary representation of ASCII (7 bit) value is 1000001. Also 01000001 in ASCII-8 bit.

### 2.7.3 Extended Binary Coded Decimal Interchange Code (EBCDIC)

This is similar to ASCII Code with 8 bit representation. This coding system is formulated by International Business Machine(IBM). The coding system can handle 256 characters. The input code in ASCII can be converted to EBCDIC system and vice - versa.

### 2.7.4 Indian Standard Code for Information Interchange (ISCII)

ISCII is the system of handling the character of Indian local languages. This as a 8-bit coding system. Therefore it can handle  $2^8$  characters. This system is formulated by the department of Electronics in India in the year 1986-88 and recognized by Bureau of Indian Standards (BIS). Now this coding system is integrated with Unicode.

### 2.7.5 Unicode

This coding system is used in most of the modern computers. The popular coding scheme after ASCII is Unicode. ASCII can represent only 256 characters. Therefore English and European Languages alone can be handled by ASCII. Particularly there was a situation, when the languages like Tamil, Malayalam, Kannada and Telugu could not be represented by ASCII. Hence, the Unicode was generated to handle all the coding system of Universal languages. This is 16 bit code and can handle 65536 characters.

Unicode scheme is denoted by hexadecimal numbers. The Unicode table of Tamil, Malayalam, Telugu and Kannada is shown in Table 2.6

Table 2.6

Unicode Table of Tamil								Unicode Table of Malayalam									
	0B8	0B9	0BA	0BB	0BC	0BD	0BE	0BF		0D0	0D1	0D2	0D3	0D4	0D5	0D6	0D7
0		ஐ 0B90		ர 0BB0	ீ 0BC0	ஓ 0BD0		ய 0BF0	0	ஃ 0D00	ஐ 0D10	ஔ 0D20	ஔ 0D30	ஃ 0D40		ஐ 0D60	ய 0D70
1				ற 0BB1	ு 0BC1			ள 0BF1	1	ஃ 0D01		ஔ 0D21	ஔ 0D31	ஃ 0D41		ஐ 0D61	ய 0D71
2	ஃ 0B82	ஓ 0B92		ல 0BB2	ு 0BC2			க 0BF2	2	ஃ 0D02	ஓ 0D12	ஔ 0D22	ஔ 0D32	ஃ 0D42		ஐ 0D62	ய 0D72
3	ஃ 0B83	ஓ 0B93	ண 0BA3	ள 0BB3				உ 0BF3	3	ஃ 0D03	ஓ 0D13	ஔ 0D23	ஔ 0D33	ஃ 0D43		ஐ 0D63	ய 0D73
4		ஓள 0B94	த 0BA4	ழ 0BB4				ம் 0BF4	4		ஓ 0D14	ஔ 0D24	ஔ 0D34	ஃ 0D44		ஐ 0D64	ய 0D74
5	அ 0B85	க 0B95		வ 0BB5				ஶ 0BF5	5	ஓ 0D05	க 0D15	ம 0D25	வ 0D35		ஃ 0D55		ஐ 0D75
6	ஆ 0B86			ஸ 0BB6	ெ 0BC6		ஔ 0BE6	பு 0BF6	6	ஓ 0D06	வ 0D16	ஔ 0D26	ஔ 0D36	ஃ 0D46	ஃ 0D56	ஔ 0D66	ஔ 0D76
7	இ 0B87			ஷ 0BB7	ே 0BC7	ள 0BD7	க 0BE7	ஶ 0BF7	7	ஓ 0D07	ஔ 0D17	ஔ 0D27	ஔ 0D37	ஃ 0D47	ஃ 0D57	ஔ 0D67	ஔ 0D77
8	ஈ 0B88		ந 0BA8	ஸ 0BB8	ை 0BC8		ஔ 0BE8	ஶ 0BF8	8	ஓ 0D08	ஔ 0D18	ஔ 0D28	ஔ 0D38	ஃ 0D48	ஃ 0D58	ஔ 0D68	ஔ 0D78
9	உ 0B89	ங 0B99	ள 0BA9	ஶ 0BB9				ஶ 0BF9	9	ஓ 0D09	ஔ 0D19	ஔ 0D29	ஔ 0D39		ஃ 0D59	ஔ 0D69	ஔ 0D79
A	ஊ 0B8A	ச 0B9A	ப 0BAA		ொ 0BCA		ஔ 0BEA	ஶ 0BFA	A	ஓ 0D0A	ஔ 0D1A	ஔ 0D2A	ஔ 0D3A	ஃ 0D4A	ஃ 0D5A	ஔ 0D6A	ஔ 0D7A
B					ோ 0BCB		ஔ 0BEB		B	ஓ 0D0B	ஔ 0D1B	ஔ 0D2B	ஔ 0D3B	ஃ 0D4B	ஃ 0D5B	ஔ 0D6B	ஔ 0D7B
C		ஐ 0B9C			ெள 0BCC		ஔ 0BEC		C	ஓ 0D0C	ஔ 0D1C	ஔ 0D2C	ஔ 0D3C	ஃ 0D4C	ஃ 0D5C	ஔ 0D6C	ஔ 0D7C
D					ஃ 0BCD		ஔ 0BED		D		ஔ 0D1D	ஔ 0D2D	ஔ 0D3D	ஃ 0D4D	ஃ 0D5D	ஔ 0D6D	ஔ 0D7D
E	எ 0B8E	ஞ 0B9E	ம 0BAE	ா 0BBE			ஔ 0BEE		E	ஓ 0D0E	ஔ 0D1E	ஔ 0D2E	ஔ 0D3E	ஃ 0D4E	ஃ 0D5E	ஔ 0D6E	ஔ 0D7E
F	ஏ 0B8F	ழ 0B9F	ய 0BAF	ி 0BBF			ஔ 0BEF		F	ஓ 0D0F	ஔ 0D1F	ஔ 0D2F	ஔ 0D3F	ஃ 0D4F	ஃ 0D5F	ஔ 0D6F	ஔ 0D7F



Table 2.6

Unicode Table of Telugu								Unicode Table of Kannada									
	0C0	0C1	0C2	0C3	0C4	0C5	0C6	0C7		0C8	0C9	0CA	0CB	0CC	0CD	0CE	0CF
0	౦	ఱ	త	ర	్		ఱు		0	ಁ	ಱ	ತ	ರ	್		ಱು	
1	౧		డ	ఱ	ృ		౞		1	౧		ಡ	ఱ	ృ		ಱು	ಱ
2	౨	ఱ	డ	ల	ౄ		౞		2	౨	ఱ	ಡ	ల	ౄ		ಱು	ಱ
3	౩	ఱ	ఱ	ళ	ృ		౞		3	౩	ఱ	ఱ	ళ	ృ		ಱು	ಱ
4		ఱ	ఱ	ఱ	ృ				4		ఱ	ఱ	ఱ	ృ			
5	౫	౫	ఱ	ఱ		్			5	౫	౫	ఱ	ఱ		్		
6	౬	ఱ	ఱ	ఱ	ృ	్	౦		6	౬	ఱ	ఱ	ఱ	్	౦		
7	౭	ఱ	ఱ	ఱ	ృ		౦		7	౭	ఱ	ఱ	ఱ	్	౦		
8	౮	ఱ	ఱ	ఱ	ృ	ఱ	౮	౮	8	౮	ఱ	ఱ	ఱ	్	౮		
9	౯	ఱ		ఱ		ఱ	౮	౮	9	౯	ఱ		ఱ		ఱ		
A	౧౦	ఱ	ఱ		్	ఱ	౮	౮	A	౧౦	ఱ	ఱ		్	ఱ		
B	౧౧	ఱ	ఱ		్		౮	౮	B	౧౧	ఱ	ఱ		్		ఱ	
C	౧౨	ఱ	ఱ		్		౮	౮	C	౧౨	ఱ	ఱ		్		ఱ	
D		ఱ	ఱ	ృ	్		౮	౮	D		ఱ	ఱ	ృ	్		౮	
E	౧౩	ఱ	ఱ	్			౮	౮	E	౧౩	ఱ	ఱ	్		౮	౮	
F	౧౪	ఱ	ఱ	్			౮	౮	F	౧౪	ఱ	ఱ	్		౮	౮	

Appendix  
American Standard Code for Information Interchange (ASCII)  
(Few specific characters only)

**Alphabets**

Alphabets	Decimal number	Binary number (8 bit)	Octal number	Hexadecimal number
A	65	01000001	101	41
B	66	01000010	102	42
C	67	01000011	103	43
D	68	01000100	104	44
E	69	01000101	105	45
F	70	01000110	106	46
G	71	01000111	107	47
H	72	01001000	110	48
I	73	01001001	111	49
J	74	01001010	112	4A
K	75	01001011	113	4B
L	76	01001100	114	4C
M	77	01001101	115	4D
N	78	01001110	116	4E
O	79	01001111	117	4F
P	80	01010000	120	50
Q	81	01010001	121	51
R	82	01010010	122	52
S	83	01010011	123	53
T	84	01010100	124	54
U	85	01010101	125	55
V	86	01010110	126	56
W	87	01010111	127	57
X	88	01011000	130	58
Y	89	01011001	131	59
Z	90	01011010	132	5A
a	97	01100001	141	61
b	98	01100010	142	62
c	99	01100011	143	63
d	100	01100100	144	64
e	101	01100101	145	65

f	102	01100110	146	66
g	103	01100111	147	67
h	104	01101000	150	68
i	105	01101001	151	69
j	106	01101010	152	6A
k	107	01101011	153	6B
l	108	01101100	154	6C
m	109	01101101	155	6D
n	110	01101110	156	6E
o	111	01101111	157	6F
p	112	01110000	160	70
q	113	01110001	161	71
r	114	01110010	162	72
s	115	01110011	163	73
t	116	01110100	164	74
u	117	01110101	165	75
v	118	01110110	166	76
w	119	01110111	167	77
x	120	01111000	170	78
y	121	01111001	171	79
z	122	01111010	172	7A

### Numerals

Alphabets	Decimal number	Binary number (8 bit)	Octal number	Hexadecimal number
0	48	00110000	60	30
1	49	00110001	61	31
2	50	00110010	62	32
3	51	00110011	63	33
4	52	00110100	64	34
5	53	00110101	65	35
6	54	00110110	66	36
7	55	00110111	67	37
8	56	00111000	70	38
9	57	00111001	71	39

## Special Characters

Special symbols	Decimal number	Binary number (8 bit)	Octal number	Hexadecimal number
Blank	32	00100000	40	20
!	33	00100001	41	21
"	34	00100010	42	22
#	35	00100011	43	23
\$	36	00100100	44	24
%	37	00100101	45	25
&	38	00100110	46	26
'	39	00100111	47	27
(	40	00101000	50	28
)	41	00101001	51	29
*	42	00101010	52	2A
+	43	00101011	53	2B
,	44	00101100	54	2C
-	45	00101101	55	2D
.	46	00101110	56	2E
/	47	00101111	57	2F
:	58	00111010	72	3A
;	59	00111011	73	3B
<	60	00111100	74	3C
=	61	00111101	75	3D
>	62	00111110	76	3E
?	63	00111111	77	3F
@	64	01000000	100	40
[	91	01011011	133	5B
\	92	01011100	134	5C
]	93	01011101	135	5D
^	94	01011110	136	5E
_	95	01011111	137	5F
`	96	01100000	140	60
{	123	01111011	173	7B
	124	01111100	174	7C
}	125	01111101	175	7D
~	126	01111110	176	7E

## Evaluation



### Part-I

Choose the correct answer

- Which refers to the number of bits processed by a computer's CPU?
 
  - Byte
  - Nibble
  - Word length
  - Bit
- How many bytes does 1 KiloByte contain?
  - 1000
  - 8
  - 4
  - 1024
- Expansion for ASCII
  - American School Code for Information Interchange
  - American Standard Code for Information Interchange
  - All Standard Code for Information Interchange
  - American Society Code for Information Interchange
- $2^{50}$  is referred as
  - Kilo
  - Tera
  - Peta
  - Zetta
- How many characters can be handled in Binary Coded Decimal System?
  - 64
  - 255
  - 256
  - 128
- For  $1101_2$  the equivalent Hexadecimal equivalent is?
  - F
  - E
  - D
  - B
- What is the 1's complement of  $00100110$ ?
  - 00100110
  - 11011001
  - 11010001
  - 00101001

- Which amongst this is not an Octal number?
  - 645
  - 234
  - 876
  - 123

### Part-II

#### Very Short Answers

- What is data?
- Write the 1's complement procedure.
- Convert  $(46)_{10}$  into Binary number
- We cannot find 1's complement for  $(28)_{10}$ . State reason.
- List the encoding systems that represents characters in memory.

### Part-III

#### Short Answers

- What is radix of a number system? Give example
- Write note on binary number system.
- Convert  $(150)_{10}$  into Binary, then convert that Binary number to Octal
- Write short note on ISCII
- Add a)  $-22_{10} + 15_{10}$  b)  $20_{10} + 25_{10}$

### Part-IV

#### Explain in Detail

- Write the procedure to convert fractional Decimal to Binary
  - Convert  $(98.46)_{10}$  to Binary
- Find 1's Complement and 2's Complement for the following Decimal number
  - 98
  - 135
- Add  $1101010_2 + 101101_2$
  - Subtract  $1101011_2 - 111010_2$

### Learning Objectives

- To know the organisation of the computer components and their interconnections.
- To know the processors and their characteristics.
- To know the importance of memory devices and their roles in a computer.
- To explore RAM, ROM and differentiate each of them.
- To know about cache memory and how it improves the performance of a computer
- To know the secondary devices and their usage
- To know about the ports and interfaces so that external devices can be connected



### 3.1 Introduction

Computer organisation deals with the hardware components of a computer system. It includes Input / Output devices, the Central Processing Unit, storage devices and primary memory. It is concerned with how the various components of computer hardware operate. It also deals with how they are interconnected to implement an architectural specification. The term computer organisation looks similar to the term computer architecture. But, computer architecture deals with the

## Computer Organisation

engineering considerations involved in designing a computer. On the other hand, Computer Organisation deals with the hardware components that are transparent to the programmer.

### 3.2. Basics of Microprocessors

The CPU is the major component of a computer, which performs all tasks. This is realized by the microprocessor which is an Integrated Circuit. Microprocessors were first introduced in early 1970s. The first general purpose microprocessor, 4004 was developed by Intel Inc.

The microprocessor is a programmable multipurpose silicon chip. It is driven by clock pulses. It accepts input as a binary data and after processing, it provides the output data as per the instructions stored in the memory. A block diagram of a microprocessor based system is shown in Figure 3.1.

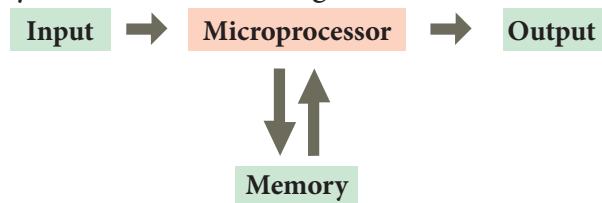

Figure 3.1 A Microprocessor - Based System

The microprocessor is made up of 3 main units. They are:

- **Arithmetic and Logic unit (ALU):** To perform arithmetic and logical instructions based on computer instructions.

- **Control unit:** To control the overall operations of the computer through signals.
- **Registers (Internal Memory):** They are used to hold the instruction and data for the execution of the processor.

### Characteristics of Microprocessors

□ A Microprocessor's performance depends on the following characteristics:

- a) Clock speed
  - b) Instruction set
  - c) Word size
- a) **Clock Speed**

Every microprocessor has an **internal clock** that regulates the speed at which it executes instructions. The speed at which the microprocessor executes instructions is called the **clock speed**. Clock speed is measured in MHz (Mega Hertz) or in GHz (Giga Hertz).

### b) Instruction Set

A command which is given to a computer to perform an operation on data is called an **instruction**. Basic set of machine level instructions that a microprocessor is designed to execute is called as an **instruction set**. This

### Speed Measurement



**Hertz** – abbreviated as Hz is the standard unit of measurement used for measuring frequency. Since frequency is measured in cycles per second, one hertz equals one cycle per second.

Hertz is commonly used to measure wave frequencies, such as sound waves, light waves, and radio waves. For example, the average human ear can detect sound waves between 20 and 20,000 Hz. Sound waves close to 20 Hz have a low pitch and are called "bass" frequencies. Sound waves above 5,000 Hz have a high pitch and are called "treble" frequencies.

While hertz can be used to measure wave frequencies, it is also used to measure the speed of computer processors. For example, each CPU is rated at a specific clock speed. This number indicates how many instruction cycles the processor can perform in every second. Since modern processors can perform millions or even billions of instructions per second, clock speeds are typically measured in megahertz or gigahertz.

instruction set carries out the following types of operations:

- Data transfer
  - Arithmetic operations
  - Logical operations
  - Control flow
  - Input/output
- c) **Word Size**
- The number of bits that can be processed by a processor in a single instruction

is called its word size. **Word size** determines the amount of RAM that can be accessed by a microprocessor.

### 3.3 Data communication between CPU and memory

□ The Central Processing Unit(CPU) has a Memory Data Register (MDR) and a Memory Address Register (MAR). The Memory Data Register (MDR) keeps the data which is transferred between the Memory and the CPU. The Program Counter (PC) is a special register in the CPU which always keeps the address of the next instruction to be

executed. The Arithmetic and Logic unit of CPU places the address of the memory to be fetched, into the Memory Address Register.

A bus is a collection of wires used for communication between the internal components of a computer.

The word in the RAM has the same size (no. of bits) as the Memory Data Register (MDR). If the processor is an 8-bit processor like Intel 8085, its MDR and the word in the RAM both have 8 bits.

The read operation transfers the data(bits) from word to Memory Data Register. The write operation transfers the data(bits) from Memory Data Register to word.



If 5V is applied at one end of a wire, the other end also can receive 5V. In the same way, the buses are wires, and the binary data are voltages (5V as 1 and 0V as 0), and these buses can simply pass the data as voltages from one end to other.

### 3.4 Types of Microprocessors

Microprocessors can be classified based on the following criteria:

- The width of data that can be processed
- The instruction set

#### 3.4.1 Classification of Microprocessors based on the Data Width

Depending on the data width, microprocessors can process instructions. The microprocessors can be classified as

follows:

- 8-bit microprocessor
- 16-bit microprocessor
- 32-bit microprocessor
- 64-bit microprocessor

#### 3.4.2 Classification of Microprocessors based on Instruction Set

The size of the instruction set is an important consideration while categorizing microprocessors. There are two types of microprocessors based on their instruction sets.

- Reduced Instruction Set Computers (RISC)
- Complex Instruction Set Computers (CISC)

Examples of RISC processors are Pentium IV, Intel P6, AMD K6 and K7.

Examples of CISC processors are Intel 386 & 486, Pentium, Pentium II and III, and Motorola 68000.

### 3.5 Memory Devices

A memory is just like a human brain. It is used to store data and instructions. Computer memory is the storage space in the computer, where data and instructions are stored. There are two types of accessing methods to access (read or write) the memory. They are sequential access and random access. In sequential access, the memory is accessed in an



orderly manner from starting to end. But, in random access, any byte of memory can be accessed directly without navigating through previous bytes. Different memory devices are arranged according to the capacity, speed and cost as shown in Figure 3.6.

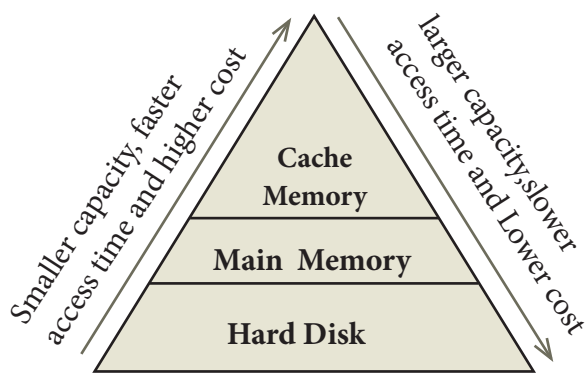

Figure 3.6 Memory Hierarchy

### 3.5.1 Random-Access Memory (RAM)

The main memory is otherwise called as **Random Access Memory**. This is available in computers in the form of Integrated Circuits (ICs). It is the place in a computer where the Operating System, Application Programs and the data in current use are kept temporarily so that they can be accessed by the computer's processor. The smallest unit of information that can be stored in the memory is called as a bit. The memory can be accessed by a collection of 8 bits which is called as a byte.

RAM is a volatile memory, which means that the information stored in it is not permanent. As soon as the power is turned off, whatever data that resides in RAM is lost. It allows both read and write operations.

### 3.5.2 Types of RAM

There are two basic types of RAM

- Dynamic RAM (DRAM)
- Static RAM (SRAM)

These two types differ in the

technology they use to hold data. Dynamic RAM being a common type needs to be refreshed frequently. Static RAM needs to be refreshed less often, which makes it faster. Hence, Static RAM is more expensive than Dynamic RAM.

### 3.5.3 Read Only Memory (ROM)

Read Only Memory refers to special memory in a computer with pre-recorded data at manufacturing time which cannot be modified. The stored programs that start the computer and perform diagnostics are available in ROMs. ROM stores critical programs such as the program that boots the computer. Once the data has been written onto a ROM chip, it cannot be modified or removed and can only be read. ROM retains its contents even when the computer is turned off. So, ROM is called as a non-volatile memory.

#### 3.5.3.1 Programmable Read Only Memory (PROM)

Programmable read only memory is also a non-volatile memory on which data can be written only once. Once a program has been written onto a PROM, it remains there forever. Unlike the main memory, PROMs retain their contents even when the computer is turned off.

The PROM differs from ROM. PROM is manufactured as a blank memory, whereas a ROM is programmed during the manufacturing process itself. PROM programmer or a PROM burner is used to write data to a PROM chip. The process of programming a PROM is called burning the PROM.

#### 3.5.3.2 Erasable Programmable Read Only Memory (EPROM)

Erasable Programmable Read Only Memory is a special type of memory which

serves as a PROM, but the content can be erased using ultraviolet rays. EPROM retains its contents until it is exposed to ultraviolet light. The ultraviolet light clears its contents, making it possible to reprogram the memory.

An EPROM differs from a PROM, PROM can be written only once and cannot be erased. EPROMs are used widely in personal computers because they enable the manufacturer to change the contents of the PROM to replace with updated versions or erase the contents before the computer is delivered.

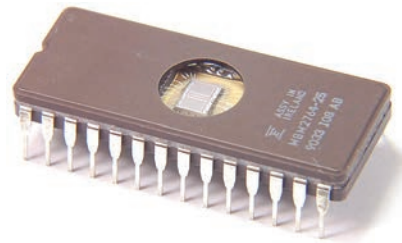

Figure 3.7 Erasable Programmable Read Only Memory



Most of the EPROM chips have a transparent area at the top surface which is covered by stickers. If it gets removed, the ultraviolet light in the sunlight may erase the contents.

### 3.5.3.3 Electrically Erasable Programmable Read Only Memory (EEPROM)

Electrically Erasable Programmable Read Only Memory is a special type of PROM that can be erased by exposing it to an electrical charge. Like other types of PROM, EEPROM retains its contents even when the power is turned off. Comparing with all other types of ROM, EEPROM is slower in performance.

### 3.5.4 Cache Memory

The cache memory is a very high speed and expensive memory, which is used to speed

up the memory retrieval process. Due to its higher cost, the CPU comes with a smaller size of cache memory compared with the size of the main memory. Without cache memory, every time the CPU requests the data, it has to be fetched from the main memory which will consume more time. The idea of introducing a cache is that, this extremely fast memory would store data that is frequently accessed and if possible, the data that is closer to it. This helps to achieve the fast response time, Where response Time, (Access Time) refers to how quickly the memory can respond to a read / write request. Figure 3.8 shows the arrangement of cache memory between the CPU and the main memory.

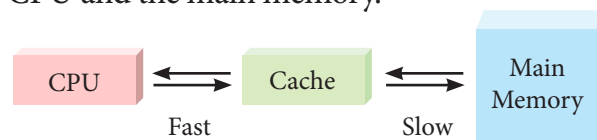

Figure 3.8 Cache Memory Arrangement

## 3.6 Secondary Storage Devices

A computer generally has limited amount of main memory which is expensive and volatile. To store data and programs permanently, secondary storage devices are used. Secondary storage devices serve as a supportive storage to main memory and they are non-volatile in nature, secondary storage is also called as Backup storage

### 3.6.1 Hard Disk

Hard disk is a magnetic disk on which you can store data. The hard disk has the stacked arrangement of disks accessed by a pair of heads for each of the disks. The hard disks come with a single or double sided disk.

### 3.6.2 Compact Disc (CD)

A CD or CD-ROM is made from 1.2 millimeters thick, polycarbonate plastic material. A thin layer of aluminium or gold is applied to the surface. CD data is represented as tiny indentations known as

"pits", encoded in a spiral track moulded into the top of the polycarbonate layer. The areas between pits are known as "lands". A motor within the CD player rotates the disk. The capacity of an ordinary CD-ROM is 700MB.



Fig 3.9 Compact Disc

### 3.6.3 Digital Versatile Disc (DVD)

A **DVD (Digital Versatile Disc or Digital Video Disc)** is an optical disc capable of storing up to 4.7 GB of data, more than six times what a CD can hold. DVDs are often used to store movies at a better quality. Like CDs, DVDs are read with a laser.

The disc can have one or two sides, and one or two layers of data per side; the number of sides and layers determines how much it can hold. Double-layered sides are usually gold-coloured, while single-layered sides are usually silver-coloured, like a CD.



Fig 3.10 Digital Versatile Disc

### 3.6.4 Flash Memory Devices

Flash memory is an electronic (solid-state) non-volatile computer storage medium that can be electrically erased and reprogrammed. They are either EEPROM or EPROM. Examples for Flash memories are pendrives, memory cards etc. Flash memories can be used in personal computers, Personal Digital Assistants (PDA), digital audio

players, digital cameras and mobile phones. Flash memory offers fast access times. The time taken to read or write a character in memory is called access time. The capacity of the flash memories vary from 1 Gigabytes (GB) to 2 Terabytes (TB). A sample of flash memory is shown in Figure 3.11.



Figure 3.11 Flash Memory

### 3.6.5 Blu-Ray Disc

Blu-Ray Disc is a high-density optical disc similar to DVD. Blu-ray is the type of disc used for PlayStation games and for playing High-Definition (HD) movies. A double-layer Blu-Ray disc can store up to 50GB (gigabytes) of data. DVD uses a red laser to read and write data. But, Blu-ray uses a blue-violet laser to write. Hence, it is called as Blu-Ray.



Fig 3.12 Blu- Ray Disc

## 3.7 Ports and Interfaces

The Motherboard of a computer has many I/O sockets that are connected to the ports and interfaces found on the rear side of a computer (Figure 3.13). The external devices can be connected to the ports and interfaces. The various types of ports are given below:

**Serial Port:** To connect the external devices, found in old computers.

**Parallel Port:** To connect the printers, found in old computers.

**USB Ports:** To connect external devices like cameras, scanners, mobile phones, external hard disks and printers to the computer.

**USB 3.0** is the third major version of the Universal Serial Bus (USB) standard to connect computers with other electronic gadgets as shown in Figure 3.13. USB 3.0 can transfer data up to 5 Giga byte/second. USB3.1 and USB 3.2 are also released.



Figure 3.13 USB 3.0 Ports

**VGA Connector:** To connect a monitor or any display device like LCD projector.

**Audio Plugs:** To connect sound speakers, microphone and headphones.

**PS/2 Port:** To connect mouse and keyboard to PC.

**SCSI Port:** To connect the hard disk drives and network connectors.

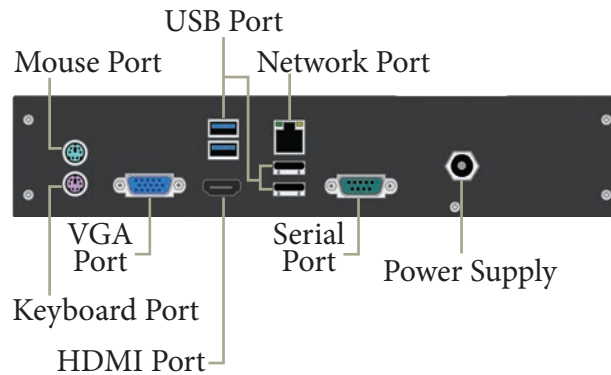

Fig 3.14 Ports and Interfaces

### High Definition Multimedia Interface (HDMI)

High-Definition Multimedia Interface is an audio/video interface which transfers the uncompressed video and audio data from a video controller, to a compatible computer monitor, LCD projector, digital television etc.

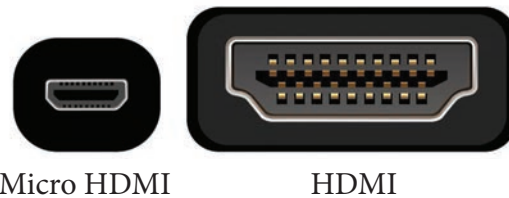

Figure 3.15 HDMI Ports

### Activity

#### Student Activity

- Identify the components of a computer
- Connecting external devices like printer/LCD projector.

#### Teacher Activity

- Show the components of a computer
- Display different ROM ICs
- Display the flash memory
- Demonstrate various ports and their usage

## Evaluation



### Part – I

#### Choose the correct answer

1. Which of the following is said to be the brain of a computer?
  - (a) Input devices
  - (b) Output devices
  - (c) Memory device
  - (d) Microprocessor
2. Which of the following is not the part of a microprocessor unit?
  - (a) ALU
  - (b) Control unit
  - (c) Cache memory
  - (d) register
3. How many bits constitute a word?
  - (a) 8
  - (b) 16
  - (c) 32
  - (d) determined by the processor used.
4. Which of the following device identifies the location when address is placed in the memory address register?
  - (a) Locator
  - (b) encoder
  - (c) decoder
  - (d) multiplexer
5. Which of the following is a CISC processor?
  - (a) Intel P6
  - (b) AMD K6
  - (c) Pentium III
  - (d) Pentium IV
6. Which is the fastest memory?
  - (a) Hard disk
  - (b) Main memory
  - (c) Cache memory
  - (d) Blue-Ray disc
7. How many memory locations are identified by a processor with 8 bits address bus at a time?
  - (a) 28
  - (b) 1024
  - (c) 256
  - (d) 8000
8. What is the capacity of 12cm diameter DVD with single sided and single layer?
  - (a) 4.7 GB
  - (b) 5.5 GB
  - (c) 7.8GB
  - (d) 2.2 GB
9. What is the smallest size of data represented in a CD?
  - (a) blocks
  - (b) sectors
  - (c) pits
  - (d) tracks
10. Display devices are connected to the computer through.
  - (a) USB port
  - (b) Ps/2 port
  - (c) SCSI port
  - (d) VGA connector

### Part – II

#### Very Short Answers

- (1) What are the parameters which influence the characteristics of a microprocessor?
- (2) What is an instruction?
- (3) What is a program counter?
- (4) What is HDMI?
- (5) Which source is used to erase the content of a EPROM?

### Part-III

#### Short Answers

- (1) Differentiate Computer Organisation from Computer Architecture.

- (2) Classify the microprocessor based on the size of the data.
- (3) Write down the classifications of microprocessors based on the instruction set.
- (4) Differentiate PROM and EPROM.
- (5) Write down the interfaces and ports available in a computer.
- (6) Differentiate CD and DVD
- (7) How will you differentiate a flash memory and an EEPROM?

#### Part-IV

#### Explain in Detail

- (1) Explain the characteristics of a microprocessor.
- (2) How the read and write operations are performed by a processor? Explain.
- (3) Arrange the memory devices in ascending order based on the access time.
- (4) Explain the types of ROM.



<b>Computer hardware</b>	The physical parts or components of a computer, such as the CPU, mother board, monitor, keyboard, etc.
<b>Intel</b>	Intel Corporation is an American multinational corporation and technology company involving in hardware manufacturing, especially mother board and processors
<b>Silicon chip</b>	Silicon chip is an integrated , set of electronic circuits on one small flat piece of semiconductor material, silicon.
<b>Multipurpose</b>	Multipurpose is several purpose
<b>Address bus</b>	Address bus is a collection of wires that carry the address as bits
<b>Data bus</b>	Data bus is a collection of wires to carry data in bits
<b>Control bus</b>	Control bus is a control line/collection of wires to control the operations/functions
<b>Arithmetic operations</b>	Arithmetic operations are the mathematical operations on data like add, subtract etc
<b>Data Transfer</b>	Data Transfer means moving data from one component to another
<b>Logical operations</b>	Logical operations are the operations on binary/Boolean data like AND, OR , NOT
<b>Bidirectional</b>	Bidirectional means both the directions/ways
<b>Unidirectional</b>	Unidirectional means only one direction
<b>Access time</b>	Access time is the time delay or latency between a request to an electronic system, and the access being completed or the requested data returned

## Theoretical concepts of Operating System



### Learning objectives

- ✓ To know the concept of Operating Systems and their types.
- ✓ To acquire the basic Knowledge of Operating Systems and its functions.

### 4.1 Introduction to Software

A software is set of instructions that perform specific task. It interacts basically with the hardware to generate the desired output.

#### 4.1.1 Types of Software

Software is classified into two types:

- 1) Application Software
- 2) System Software

#### Application Software:

Application software is a set of programs to perform specific task. For example MS-word is an application software to create text document and VLC player is familiar application software to play audio, video files and many more.

#### System Software:

System software is a type of computer program that is designed to run the computer's hardware and application programs. Example Operating System and Language Processor

### 4.2 Introduction to Operating System (OS)

An Operating System (OS) is a system software which serves as an interface between a user and a computer.

This controls input, output and other peripheral devices such as disk drives, printers and electronic gadgets. The functions of an Operating System include file management, memory management, process management and device management and many more.



Figure: 4.1 Operating System

Without an Operating System, a computer cannot effectively manage all the resources. When a computer is switched on, the operating system is loaded in to the memory automatically.

Some of the popular Operating Systems used in personal computers and laptops are **Windows**, **UNIX** and **Linux**. The mobile devices mostly use Android and iOS as mobile OS.

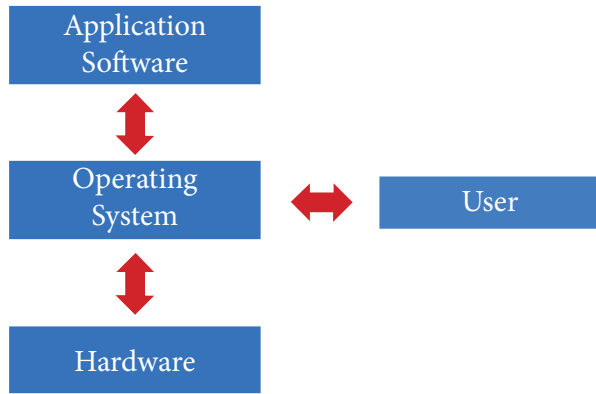

Figure: 4.2 Interaction of Operating system and user

### Uses of Operating Systems

The following are few uses of Operating System

The main use of Operating System is

- ▲ to ensure that a computer can be used to extract what the user wants it do.
- ▲ Easy interaction between the users and computers.
- ▲ Starting computer operation automatically when power is turned on (Booting).
- ▲ Controlling Input and Output Devices
- ▲ Manage the utilisation of main memory.
- ▲ Providing security to user programs.

### 4.3 Types of Operating System

Operating System are classified into the following types depending on their processing capabilities.

#### 4.3.1 Single User Operating Systems

An operating system allows only a single user to perform a task at a time. It is called as a Single user and single Task operating system. MS-DOS is an example for a single user and single task Operating System.

#### 4.3.2 Multi-user Operating Systems

It is used in computers and laptops that allow same data and applications to be accessed by multiple users at the same time. The users can also communicate with each other. Windows, Linux and UNIX are examples for multi-user Operating System.

### 4.4 Key features of the Operating System

The various key features are given below

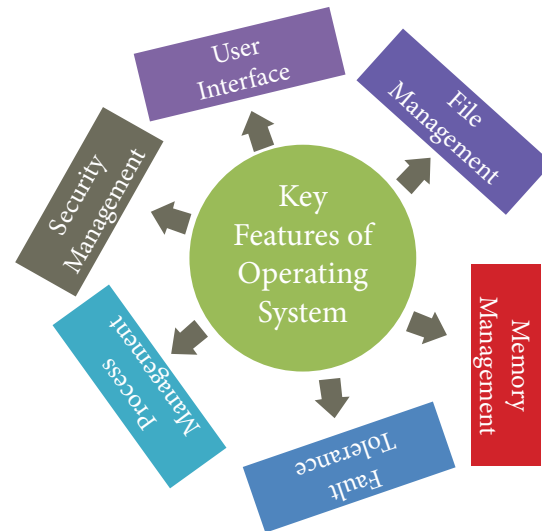

Figure: 4.3 Key Features of the Operating System

#### 4.4.1 User Interface (UI)

User interface is one of the significant feature in Operating System. The only way that user can make interaction with a computer. This is a main reason for key success of GUI (Graphical User Interface) based Operating System. The GUI is a window based system with a pointing device to direct I/O, choose from menus, make selections and a keyboard to enter text. Its vibrant colours attract the user very easily.



Now Linux distribution is also available as GUI based Operating System. The following points are considered when User Interface is designed for an application.

1. The user interface should enable the user to retain this expertise for a longer time.
2. The user interface should also satisfy the customer based on their needs.
3. The user interface should save user's precious time.
4. The ultimate aim of any product is to satisfy the customer. The User Interface is also to satisfy the customer.
5. The user interface should reduce number of errors committed by the user

#### 4.4.2 Memory Management

Memory Management is the process of controlling and coordinating computer's main memory and assigning memory block (space) to various running programs to optimize overall computer performance. The Memory management involves the allocation of specific memory blocks to individual programs based on user demands.

The objective of Memory Management process is to improve both the utilization of the CPU and the speed of the computer's response to its users via main memory. For these reasons the computers must keep several programs in main memory that associates with many different Memory Management schemes.

The Operating System is responsible for the following activities in connection with memory management:

- Keeping track of which portion of memory are currently being used and who is using them.
- Determining which processes (or parts of processes) and data to move in and out of memory.
- Allocation and de-allocation of memory blocks as needed by the program in main memory. (Garbage Collection)

#### 4.4.3 Process management

Process management is function that includes creating and deleting processes(program) and providing mechanisms for processes to communicate and synchronize with each other.

. A system task, such as sending output to a printer or screen, can also be called as a Process.

A computer consists of a collection of processes, they are classified as two categories:

- Operating System processes which is executed by system code
- User Processes which is execute by user code

All these processes can potentially execute concurrently on a single CPU.

The following algorithms are mainly used to allocate the job (process) to the processor.

1. FIFO
2. SJF
3. Round Robin
4. Based on Priority

#### FIFO (First In First Out) Scheduling

This algorithm is based on queuing technique. Assume that a student is

standing in a queue (Row) to get grade sheet from his/her teacher. The other student who stands first in the queue gets his/her grade sheet first and leaves from the queue (Row). Followed by the next student in the queue gets it corrected and so on. This is the basic logic of the FIFO algorithm.

Technically, the process that enters the queue first is executed first by the CPU, followed by the next and so on. The processes are executed in the order of the queue (row).

#### **SJF (Shortest Job First) Scheduling**

This algorithm works based on the size of the job being executed by the CPU.

Consider two jobs A and B.

- 1) A = 6 kilo bytes    2) B = 9 kilo bytes

First the job "A" will be assigned and then job "B" gets its turn.

#### **Round Robin Scheduling**

The Round Robin (RR) scheduling algorithm is designed especially for time sharing systems. Jobs (processes) are assigned and processor time in a circular method. For example take three jobs A, B, C. First the job A is assigned to CPU then job B and job C and then again A, B and C and so on.

#### **Based On Priority**

The given job (process) is assigned based on a Priority. The job which has higher priority is more important than other jobs. Take two jobs A and B. Let the priority of A be 5 and priority B be 7.

Job B is assigned to the processor before job A.

#### **4.4.4 Security Management**

The major challenge in computer and software industry is to protect user's legitimate data from hackers. The Operating System provides three levels of securities to the user end. They are

- (1) File access level
- (2) System level
- (3) Network level

In order to access the files created by other people, you should have the access permission. Permissions can either be granted by the creator of the file or by the administrator of the system.

System level security is offered by the password in a multi-user environment.

Both windows and Linux offer the password facility.

Network security is an indefinable one. So people from all over the world try to provide such a security.

All the above levels of security features are provided only by the Operating System.

#### **4.4.5 Fault Tolerance**

The Operating Systems should be robust. When there is a fault, the Operating System should not crash, instead the Operating System have fault tolerance capabilities and retain the existing state of system.

#### 4.4.6 File Management

File management is an important function of OS which handles the data storage techniques. The operating System manages the files, folders and directory systems on a computer. The FAT (File Allocation Table) stores general information about files like filename, type (text or binary), size, starting address and access mode. The file manager of the operating system helps to create, edit, copy, allocate memory to the files and also updates the FAT. There are few other file management techniques available like Next Generation File System (NTFS) and ext2 (Linux).

#### 4.4.7 Multi-Processing

This is a one of the features of Operating System. It has two or more processors for a single running process (job). Processing takes place in parallel is known as parallel processing. Since the execution takes place in parallel, this feature is used for high speed execution which increases the power of computing.

#### 4.4.8 Time-sharing

This is a one of the features of Operating Systems. It allows execution of multiple tasks or processes concurrently. For each task a fixed time is allocated. This division of time is called Time-sharing. The processor switches rapidly between various processes after a time is elapsed or the process is completed.

For example assume that there are three processes called P1, P2, P3 and time allocated for each process 30, 40, 50 minutes

respectively. If the process P1 completes within 20 minutes then processor takes the next process P2 for the execution. If the process P2 could not complete within 40 minutes, then the current process P2 will be paused and switch over to the next process P3.

#### 4.4.9 Distributed Operating Systems

The Distributed Operating System is used to access shared data and files that reside in any machine around the world using internet/intranet. The users can access as if it is available on their own computer.

The advantages of distributed Operating System are as follows:

- A user at one location can make use of all the resources available at another location over the network.
- Many computer resources can be added easily in the network
- Improves the interaction with the customers and clients.
- Reduces the load on the host computer.



Figure: 4.4 Distributed Operating Systems

### 4.5 Prominent Operating Systems







Prominent OS are as follows:

- UNIX
- Microsoft Windows
- Linux
- iOS
- Android

Modern operating systems use a Graphical User Interface(GUI). A GUI lets use to your mouse to click icons, buttons, menus and everything, is clearly displayed on the screen using a combination of graphics and text elements.

#### Student Activity

Activity 1: Draw a line between the operating system logo and the correct description.

A command-line operating system is an example of Open Source software development and Free Operating System	
A popular Operating System for mobile phone technology which is not linked with Apple products.	
Used with Apple computers and works well with cloud computing.	
Designed to be used for the Apple iPhone	
Is an Operating System that is very popular in universities, companies, big enterprises etc	
The most popular GUI Operating System for personal computers.	

### Evaluation



#### Part - I

Choose the correct answer

- 1) Operating system is a
  - A)Application Software
  - B) Hardware
  - C)System Software
  - D)Component
- 2) Identify the usage of Operating Systems
  - A) Easy interaction between the human and computer
  - B) Controlling input & output Devices
  - C) Managing use of main memory
  - D) All the above
- 3) Which of the following is not a function of an Operating System?
  - A)Process Management
  - B)Memory Management
  - C)Security management
  - D)Complier Environment
- 4) Which of the following OS is a Commercially licensed Operating system?
  - A)Windows
  - B)UBUNTU
  - C)FEDORA
  - D)REDHAT
- 5) Which of the following Operating systems support Mobile Devices?
  - A)Windows 7
  - B)Linux
  - C)BOSS
  - D)iOS
- 6) File Management manages
  - A) Files
  - B) Folders



- C) Directory systems  
D) All the Above
- 7) Interactive Operating System provides  
A) Graphics User Interface (GUI)  
B) Data Distribution  
C) Security Management  
D) Real Time Processing
- 8) An example for single task operating system is  
A) Linux  
B) Windows  
C) MS-DOS  
D) Unix
- 9) The File management system used by Linux is  
A) ext2  
B) NTFS  
C) FAT  
D) NFS

### Part – II

#### Very Short Answers

- 1) List out any two uses of Operating System?
- 2) What is multi-user Operating System?
- 3) What is a GUI?
- 4) What are the security management features available in Operating System ?
- 5) What is multi-processing?
- 6) What are the different Operating Systems used in computer?

### Part-III

#### Short Answers

- 1) What are the advantages and disadvantages of Time-sharing features?
- 2) List out the key features of Operating system
- 3) Write a note on Multiprocessing

### Part-IV

#### Explain in Detail

- 1) Explain the concept of a Distributed Operating System along with its advantages.
- 2) List out the points to be noted while creating a user interface for an Operating system.
- 3) Explain the process management algorithms in Operating System.

#### References

- 1) Silberschatz, galvin gagne, Operating System concepts – john wiley&sons,inc
- 2) Andrew s. Tanenbaum, modern Operating Systems – pearson publication
- 3) Andrew s. Tanenbaum , Operating Systems design and implementation, prentice hall publication
- 4) Tom anderson, Operating Systems: principles and practice, recursive books
- 5) Thomas w. Doeppner, Operating Systems in depth: design and programming, john wiley & sons, inc

## Working with Windows Operating System



## Learning Objectives

After learning the concepts in this chapter, the students will be able

- To know the concepts of Operating System.
- To know the versions of the windows operating system.
- To know the concepts like desktop and the elements of window.
- To explore the document window.
- To compare the different types of icons.
- To explore the windows directory structure.
- To practice creating files and folders in specific drives.
- To manage the files and folders.
- To know the procedure to start and shutdown the computer.



## 5.1. Introduction to Operating System

An Operating System (OS) is a system software (Figure 5.1) that enables the hardware to communicate and operate with other software. It also acts as an interface between the user and the hardware and controls the overall execution of the computer.

Following are some of the important functions of an Operating System as discussed in the previous chapter:

- Memory Management
- Process Management
- Device Management
- File Management
- Security Management
- Control overall system performance

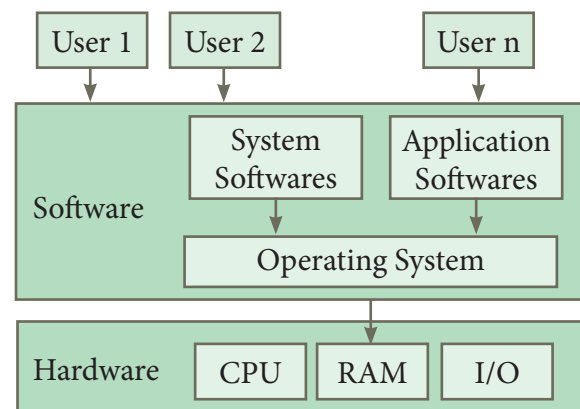

Figure 5.1. Overview of an Operating System

## 5.2. Introduction to Windows Operating System

Every computer needs an Operating System to function. Microsoft Windows is one of the most popular Graphical User Interface (GUI). Multiple applications can execute simultaneously in Windows, and this is known as “**Multitasking**”.

Windows Operating System uses both Keyboard and mouse as input devices. Mouse is used to interact with Windows by clicking its icons. Keyboard is used to enter alphabets, numerals and special characters.

### Some of the functions of Windows Operating System are:

- Access applications (programs) on the computer (word processing, games, spread sheets, calculators and so on).
- Load any new program on the computer.
- Manage hardware such as printers, scanners, mouse, digital cameras etc.,
- File management activities (For example creating, modifying, saving, deleting files and folders).







- Change computer settings such as colour scheme, screen savers of your monitor, etc.

With reference to the Table 5.1, let us see the versions of Windows Operating System.

#### 5.4. Handling the mouse

Before learning Window Operating System, you should know more about mouse and its actions.

### 5.3. Various versions of Windows

Versions	Logo	Year	Specific features
Windows 1.x		1985	<ul style="list-style-type: none"> <li>• Introduction of GUI in 16 - bit. processor</li> <li>• Mouse was introduced as an input device.</li> </ul>
Windows 2.x		1987	<ul style="list-style-type: none"> <li>• Supports to minimize or maximize windows.</li> <li>• Control panel feature was introduced with various system settings and customising options.</li> </ul>
Windows 3.x		1992	<ul style="list-style-type: none"> <li>• Introduced the concept of multitasking.</li> <li>• Supported 256 colours which brought a more modern, colourful look to the interface.</li> </ul>
Windows 95		1995	<ul style="list-style-type: none"> <li>• Introduced Start button, the taskbar, Windows Explorer and Start menu.</li> <li>• Introduced 32 - bit processor and focused more on multitasking.</li> </ul>
Windows 98		1998	<ul style="list-style-type: none"> <li>• Integration of the Web browser (Internet Explorer) with the Operating System.</li> <li>• DOS gaming began to disappear as Windows based games improved.</li> <li>• Plug and play feature was introduced.</li> </ul>
Windows NT			<ul style="list-style-type: none"> <li>• Designed to act as servers in network.</li> </ul>
Windows Me		2000	<ul style="list-style-type: none"> <li>• It introduced automated system diagnostics and recovery tools.</li> </ul>







Windows 2000		2000	<ul style="list-style-type: none"> <li>Served as an Operating System for business desktop and laptop systems.</li> <li>Four versions of Windows 2000 were released: Professional (for business desktop and laptop systems), Server (both a Web server and an office server), Advanced Server (for line-of-business applications) and Data Centre Server (for high-traffic computer networks).</li> </ul>
Windows XP		2001	<ul style="list-style-type: none"> <li>Introduced 64-bit Processor.</li> <li>Improved Windows appearance with themes and offered a stable version.</li> </ul>
Windows Vista		2006	<ul style="list-style-type: none"> <li>Updated the look and feel of Windows.</li> </ul>
Windows 7		2009	<ul style="list-style-type: none"> <li>Booting time was improved, introduced new user interfaces like Aero Peek, pinning programs to taskbar, handwriting recognition etc. and Internet Explorer 8.</li> </ul>
Windows 8		2012	<ul style="list-style-type: none"> <li>Windows 8 is faster than previous versions of Windows.</li> <li>Start button was removed.</li> <li>Windows 8 takes better advantage of multi-core processing, solid state drives (SSD), touch screens and other alternate input methods.</li> <li>Served as common platform for mobile and computer.</li> </ul>
Windows 10		2015	<ul style="list-style-type: none"> <li>Start Button was added again.</li> <li>Multiple desktop.</li> <li>Central Notification Center for App notification and quick actions.</li> <li>Cortana voice activated personal assistant.</li> </ul>

Table 5.1 Versions of Windows Operating System.

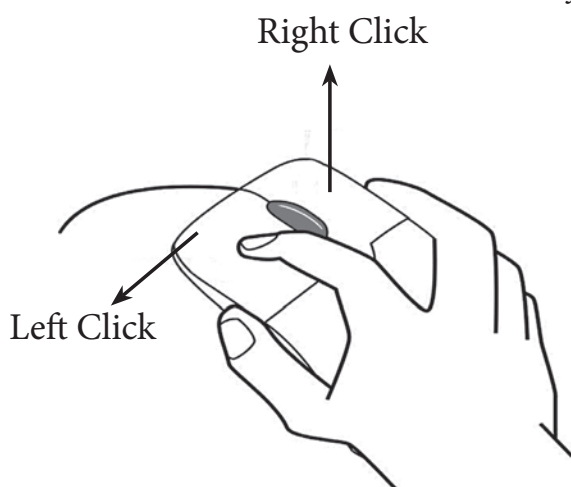

Figure 5.2. Mouse actions

**The following are the mouse actions:**

Action	Reaction
Point to an item	Move the mouse pointer over the item.
Click	Point to the item on the screen, press and release the left mouse button.
Right click	Point to the item on the screen, press and release the right mouse button. Clicking the right mouse button displays a pop up menu with various options.
Double-click	Point to the item on the screen, quickly press twice the left mouse button.



Drag and drop	Point to an item then hold the left mouse button as you move the pointer press and you have reached the desired position, release the mouse button.
---------------	---

### 5.5. Windows Desktop

The opening screen of Windows is called “Desktop”.

The desktop of your computer may look different from what is seen in Figure 5.3.

This is because Windows allows you to change the appearance of the desktop.

In Figure 5.3, the desktop shows the Start button, Taskbar, Notification Area and date and time.

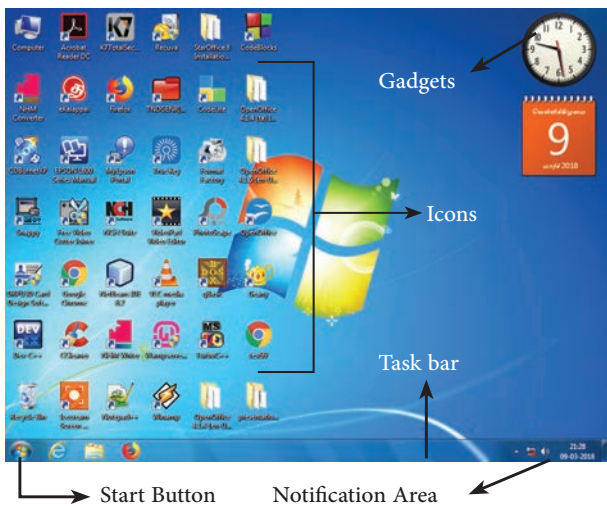

Figure 5.3. Microsoft Windows 7 Desktop

#### 5.5.1. The Icons

Icon is a graphic symbol representing the window elements like

files, folders, shortcuts etc., Icons play a vital role in GUI based applications.

##### 5.5.1.1. Standard Icons

The icons which are available on desktop by default while installing Windows OS are called standard icons. The standard icons available in all Windows OS are My Computer, Documents and Recycle Bin.



Figure 5.4. Aero peek button

##### 5.5.1.2. Shortcut Icons:

Shortcut icons can be created for any application or file or folder. By double clicking the icon, the related application or file or folder will open.

(Figure 5.5)



Figure 5.5. The types of Icons

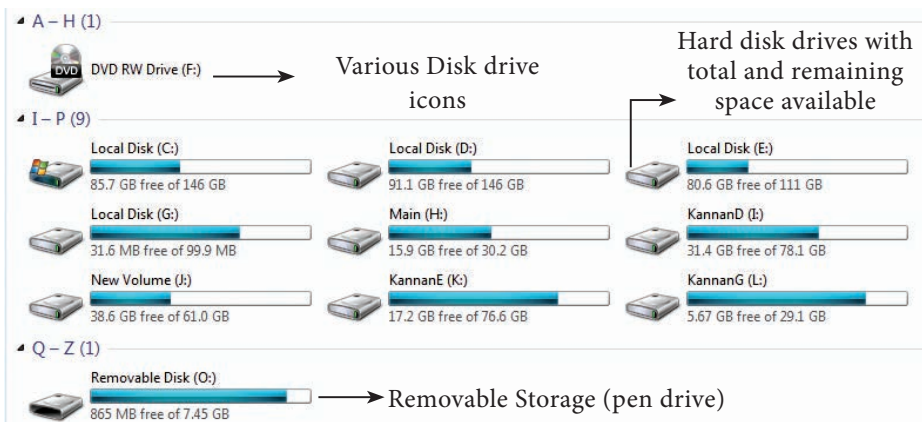

Figure 5.6. Disk drive Icons

### 5.5.1.3. Disk drive icons:

The disk drive icons graphically represent five disk drive options. (i) Hard disk (ii) CD-ROM/DVD Drive (iii) Pen drive (iv) Other removable storage such as mobile, smart phone, tablet etc., (v) Network drives if your system is connected with other system.

**DO YOU KNOW?** You can move to the Desktop any time by pressing the Winkey + D or using Aero Peek while working in any application. You can see Figure 5.4 to know where Aero peek lies in the Taskbar.

## 5.6. The Window

Window is a typical rectangular area in an application or a document. It is an area on the screen that displays information for a specific program.

## 5.7. Application Window

It is an area on a computer screen with defined boundaries, and within which information is displayed. Such windows can be resized, maximised, minimised, placed side by side, overlap, and so on.

An Application Window contains an open application i.e. current application such as Word or Paint. When two or more windows are opened, only one of them is active and the rest are inactive. Figures 5.6 and 5.7 display the Application Window of OpenOffice Writer and the appearance of the Multiple Windows opened (overlapped) in the Desktop.

## 5.8. Document Window

A document window is a section of the screen used to display the contents of a document. Figure 5.8 is an example of a document window.

### Note

When you open any application, such as OpenOffice Writer, OpenOffice Impress or OpenOffice Calc etc., you will find two Windows on the screen. The larger Window is called the Application Window. This Window helps the user to communicate with the Application program. The smaller window, which is inside the Application Window, is called the Document window. This Window is used for typing, editing, drawing, and formatting the text and graphics.

Title bar with title of the document

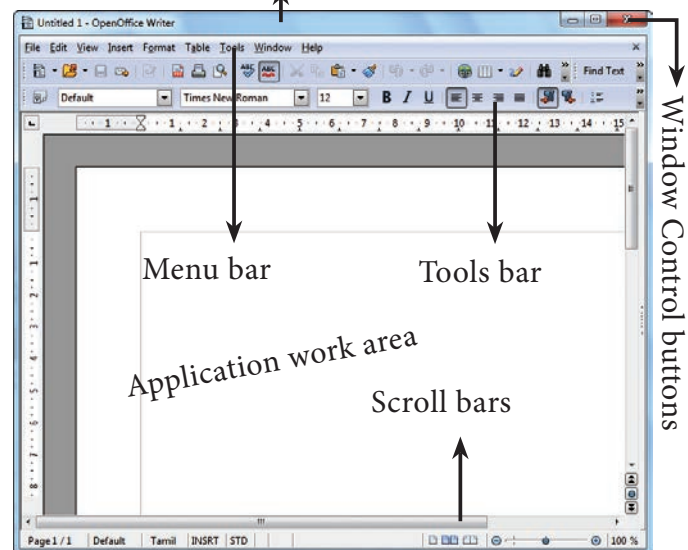

Figure 5.6. Application Window

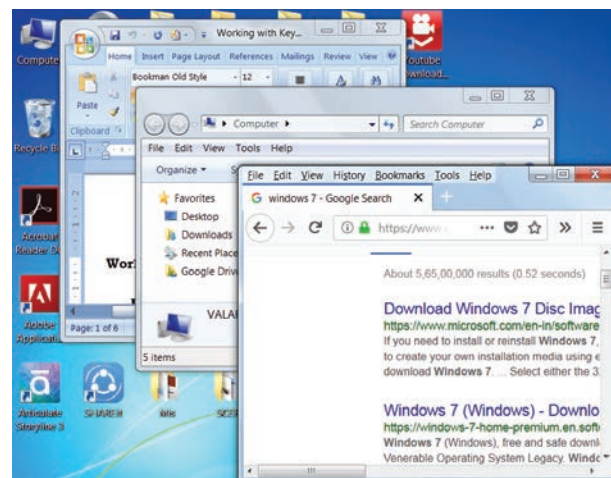

Figure 5.7. Multiple Windows opened in Desktop

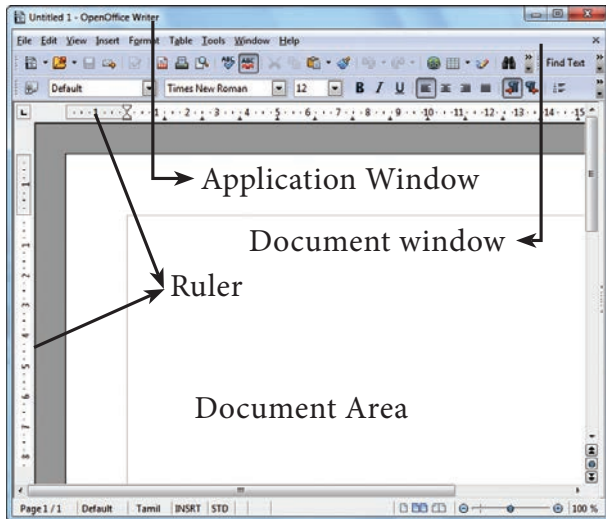

Figure 5.8. Document Window

## 5.9. Elements of a window

Figure 5.9 helps to understand the elements of a window.

**5.9.1. Title Bar** – The title bar will display the name of the application and the name of the document opened. It will also contain minimize, maximize and close button.

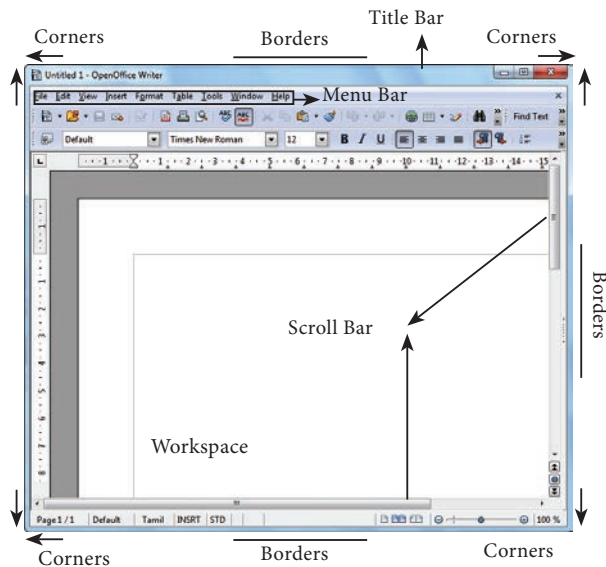

Figure 5.9 The elements of a window.

### 5.9.2 Menu Bar

The menu bar is seen under the title bar. Menus in the menu bar can be accessed by pressing Alt key and the letter that appears underlined in the menu title. Additionally, pressing Alt or F10 brings the focus on the first menu of the menu bar.

In Windows 7, in the absence of the menu bar, click **Organise** and from the drop down menu, click the **Layout** option and select the desired item from that list.

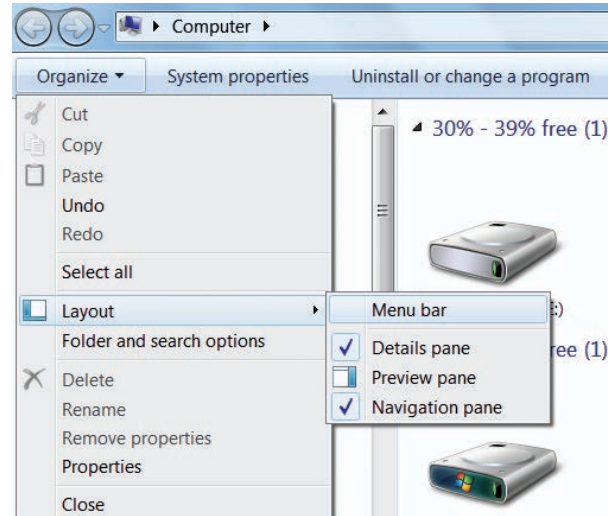

Figure 5.10. To display Menu Bar

Figure 5.10 helps to understand how to make menu bar visible in its absence.

### 5.9.3. The Workspace

The workspace is the area in the document window to enter or type the text of your document. Figure 5.10 Shows the workspace area in the document window.

**5.9.4. Scroll bars** - The scroll bars are used to scroll the workspace horizontally or vertically. Figure 5.9 shows the Scroll bars.

### 5.9.5. Corners and borders

The corners and borders of the window helps to drag and resize the windows. The mouse pointer changes to a double headed arrow when positioned over a border or a corner. Drag the border or corner in the direction indicated by the double headed arrow to the desired size as shown in Figure 5.9. The window can be resized by dragging the corners diagonally across the screen.

### 5.10.1. Start Menu

In the lower left-hand corner of the windows screen is the Start button. When you click on the button, the Start menu will appear. Using the start menu, you can start any application.

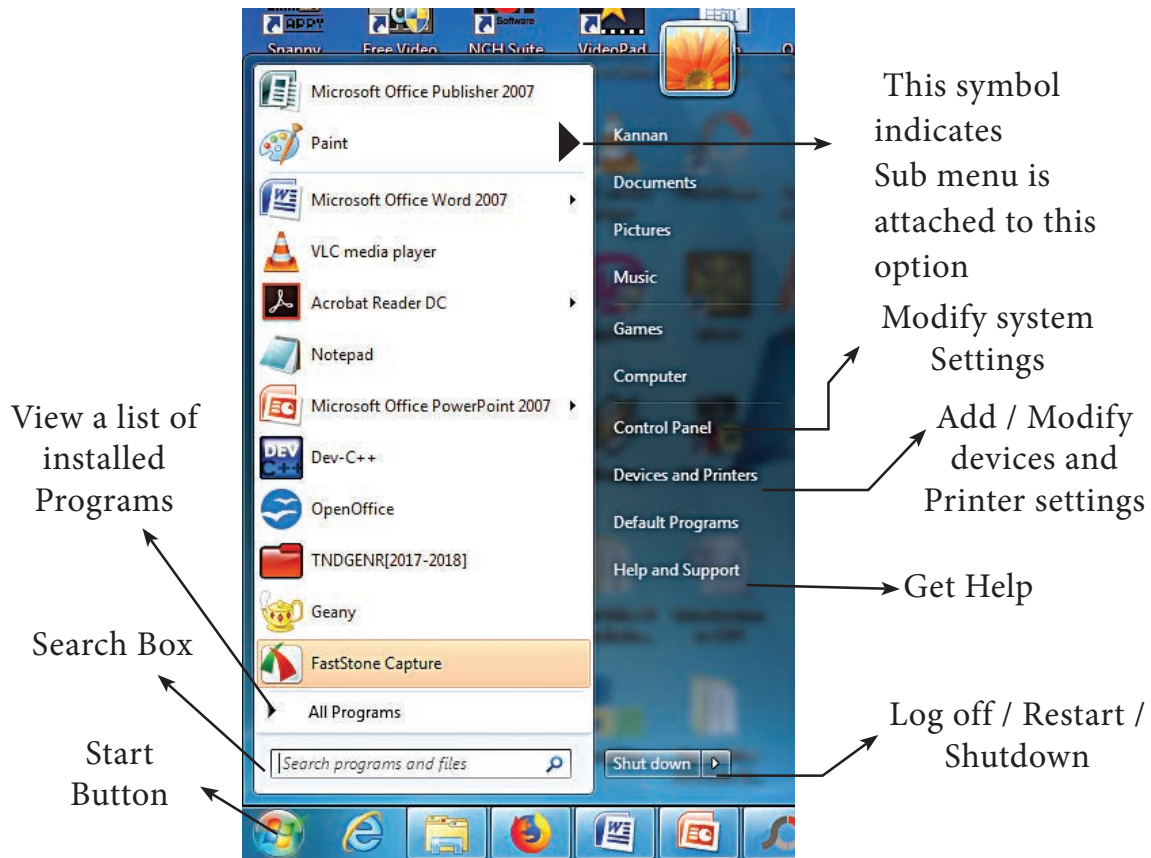

Figure 5.11 - Start Menu

### Taskbar

At the bottom of the screen is a horizontal bar called the taskbar. This bar contains (from left to right) the Start button, shortcuts to various programs, minimised programs and in the extreme right corner you can see the system tray which consist of volume control, network, date and time etc. Next to the Start button is the quick Launch Toolbar which contains task for frequently used applications.

### 5.10.2. Computer Icon

By clicking this icon, the user can see the disk drivers mounted in the system. In windows XP, Vista, this icon is called "My computer" in Windows 8 and 10, it is called "This PC". The functionality of computer icon remains the same in all versions of windows as shown in Figure 5.13.

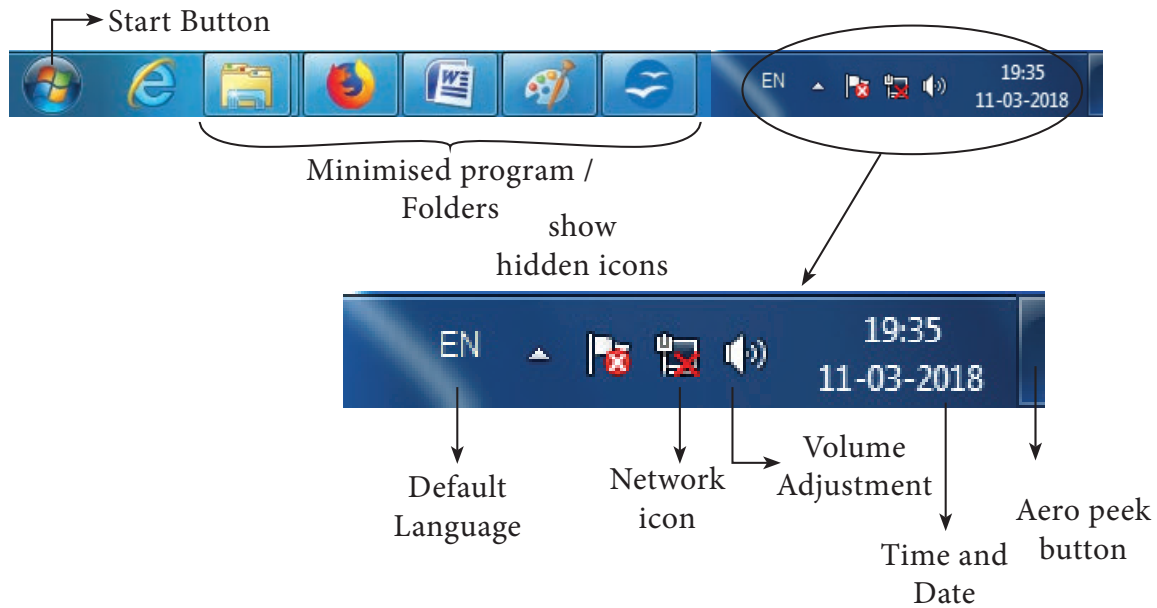

Figure 5.12. Taskbar

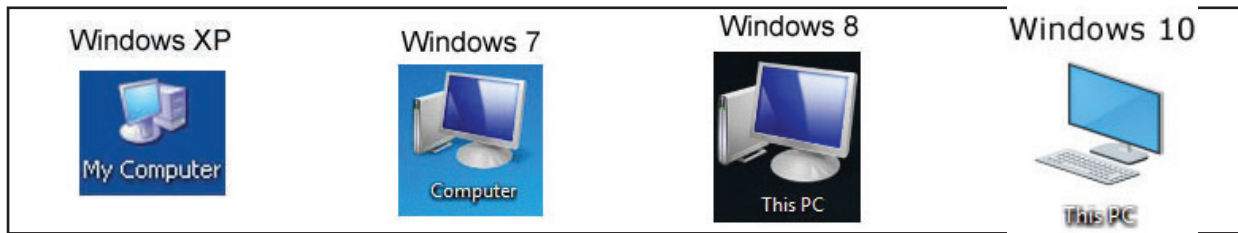

Figure 5.13. Computer icon in versions of Windows OS

### 5.10.3. Starting and Closing Applications

Most of the applications installed on your computer are available through the start menu. Depending on the system setup, the applications in the Start menu varies. To start an application:

1. Click the Start button and then point to All Programs. The Program menu appears. (Figure 5.14)
2. Point to the group that contains the application you want to start, and then click the application name.

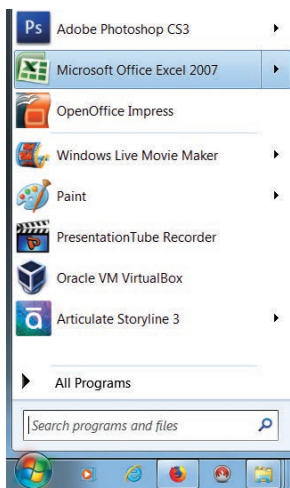

Figure 5.14. Starting a application using Start menu

3. You can also open an application by clicking Run on the Start menu, and the name of the application. (Figure 5.15)

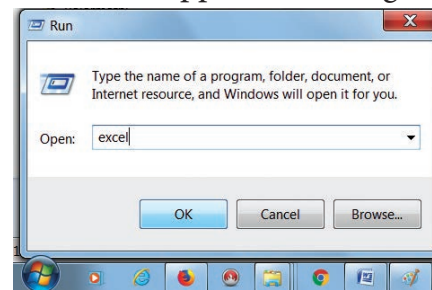

Figure 5.15. Starting a program using Run option

4. To quit an application, click the Close button in the upper right corner of the application window. (Figure 5.16)

### Workshop

1. ♦ Start the application Wordpad using Start menu and Run option. ♦ Close the Wordpad application using File menu.

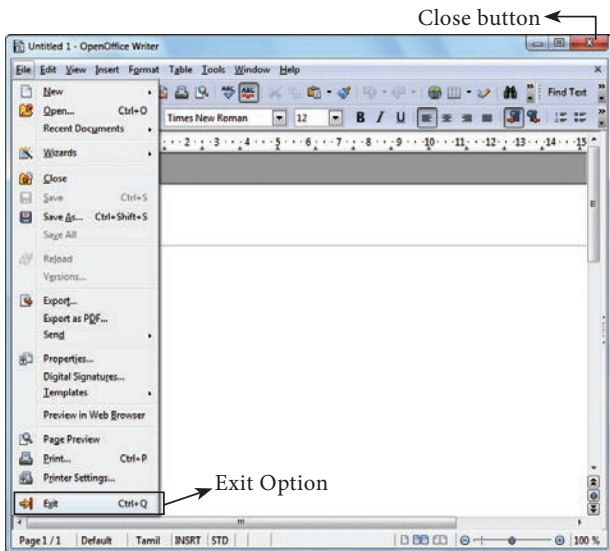

Figure 5.16. Closing the application using Close button and Exit option

5. You can also quit an application by clicking on File → Exit and File → Close option in Windows 7. (Figure 5.16)

## 5.11. Managing Files and Folders

In Windows 7, you can Organise your documents and programs in the form of files and folders. You can move, copy, rename, delete and search the files and folders.

### 5.11.1. Creating files and Folders

#### 5.11.1.1 Creating Folders

You can store your files in many locations – on the hard disk or in other devices. To better organise your files, you can store them in folders.

There are two ways in which you can create a new folder:

#### Method I:

- Step 1: Open **Computer Icon**.  
 Step 2: Open any drive where you want to create a new folder. (For example select D:)  
 Step 3: Click on File → New → Folder.  
 Step 4: A new folder is created with the default name “New folder”. (Figure 5.19)  
 Step 5: Type in the folder name and press Enter key. (Figure 5.20 shows the newly created Folder named “Test Folder”).

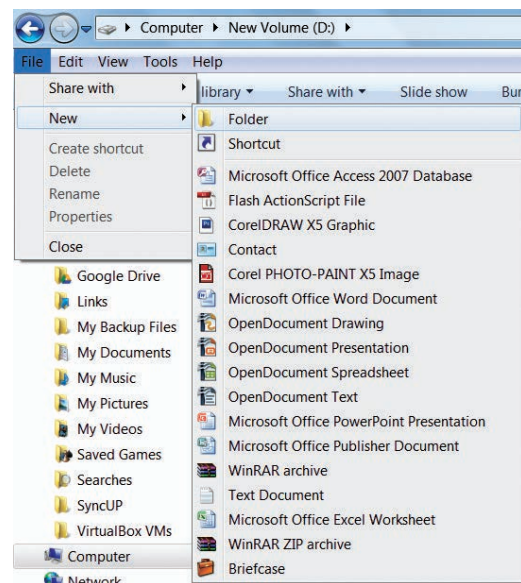

Figure 5.17. Creating a Folder using File menu

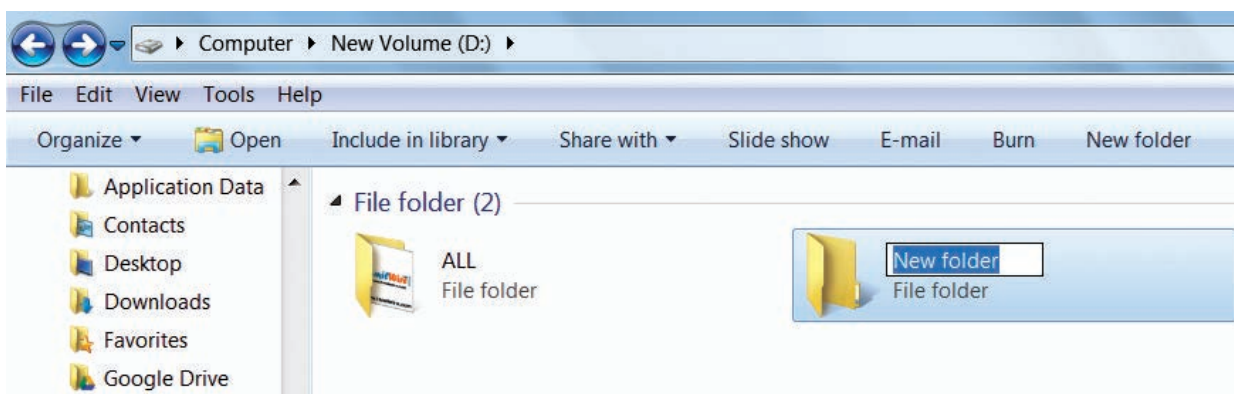

Figure 5.18. New Folder created with the default name

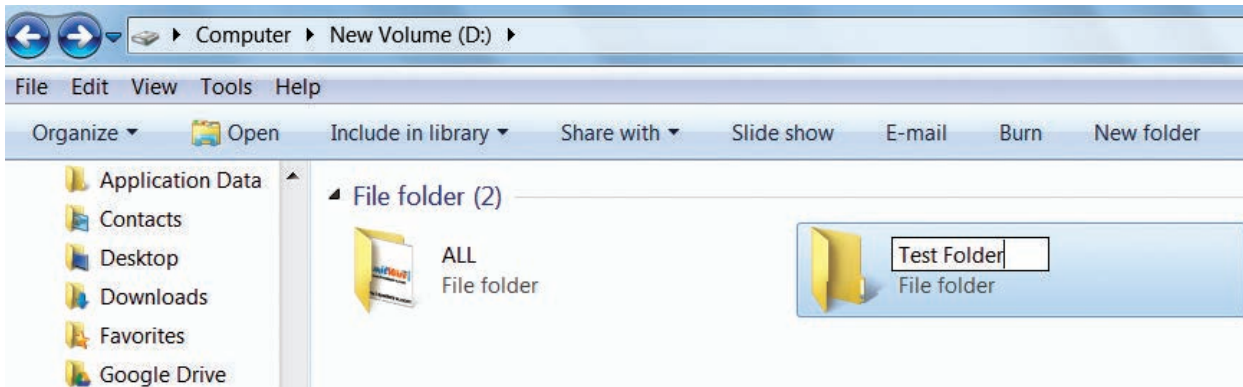

Figure 5.19. Renaming the new Folder

### Method II:

In order to create a folder in the desktop:

Step 1: In the Desktop, right click → New → Folder. (Figure 5.20 Shown the procedure)

Step 2: A Folder appears with the default name “New folder” and it will be highlighted as shown in the Figure 5.22.

Step 3: Type the name you want and press Enter Key.

Step 4: The name of the folder will change.

### Workshop

2. Create a Folder in My Documents with your name using any one of the methods discussed.

#### 5.11.1.2 Creating Files (Wordpad)

Wordpad is an in-built word processor application in Windows OS to create and manipulate text documents.

In order to create files in wordpad you need to follow the steps given below.

1. Click Start → All Programs → Accessories → Wordpad or Run → type Wordpad, click OK. Wordpad window will be opened as shown in Figure 5.22.

2. Type the contents in the workspace and save the file using File → Save or Ctrl + S.
3. Save As dialog box will be opened.
4. In the dialog box, select the location where you want to save the file by using **look in** drop down list box.
5. Type the name of the file in the **file name** text box.
6. Click save button.

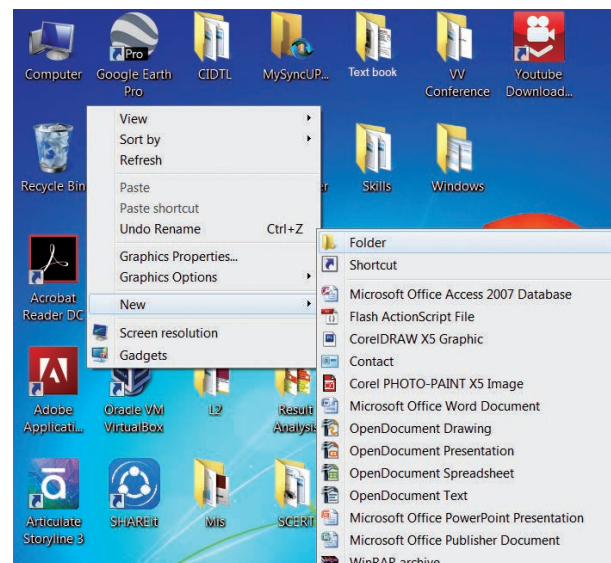

Figure 5.20. Creating a folder in the desktop

### Workshop

3. Open the Wordpad application and save it under a folder created with your name in My Documents.

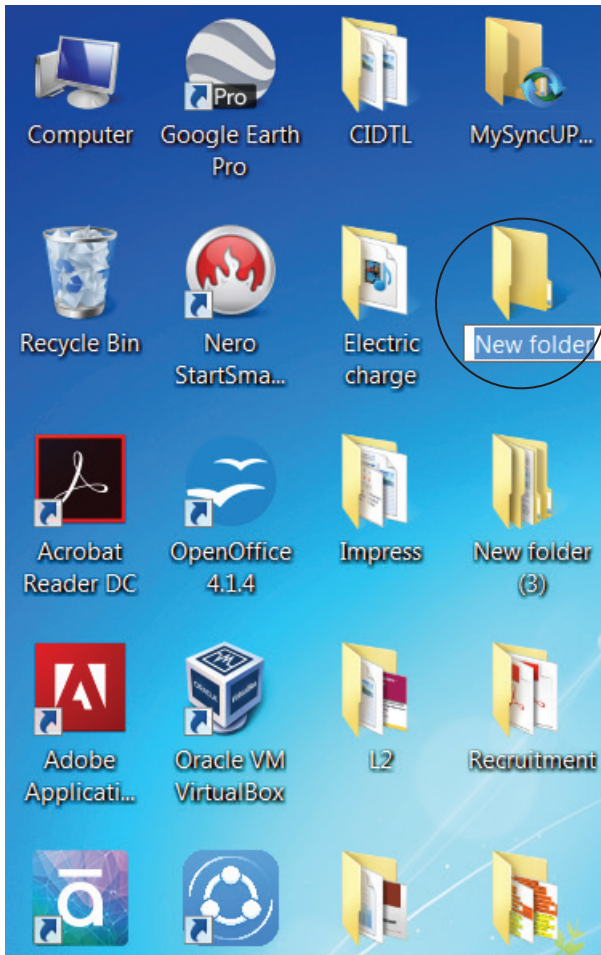

Figure 5.21 New folder icon on the desktop

### 5.11.2. Finding Files and Folders

You can use the **search** box on the **Start** menu to quickly search a particular folder or file in the computer or in a specific drive.

#### To find a file or folder:

1. Click the **Start** button, the **search** box appears at the bottom of the start menu.
2. Type the name of the file or the folder you want to search. Even if you give the part of the file or folder name, it will display the list of files or folders starting with the specified name. (Figure 5.23)
3. The files or the folders with the specified names will appear, if you

click that file, it will directly open that file or the folder.

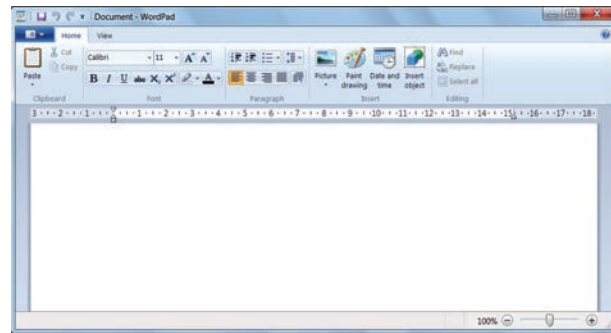

Figure 5.22. Wordpad - Word Processor application

4. There is another option called “**See more results**” which appears above the **search** box.
5. If you click it, it will lead you to a **Search Results** dialog box where you can click and open that file or the folder.

#### Searching Files or folders using Computer icon

1. Click **Computer Icon** from desktop or from **Start menu**.
2. The Computer disk drive screen will appear and at the top right corner of that screen, there is a **search** box option. (Figure 5.24)

3. Type the name of the file or the folder you want to search. Even if you give the part of the file or folder name, it will display the list of files or folders starting with the specified name.

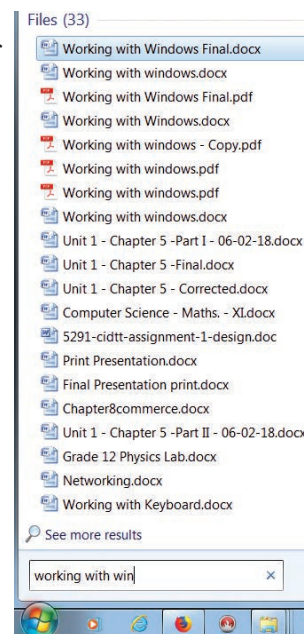

Figure 5.23. Finding a File/Folder using Start button



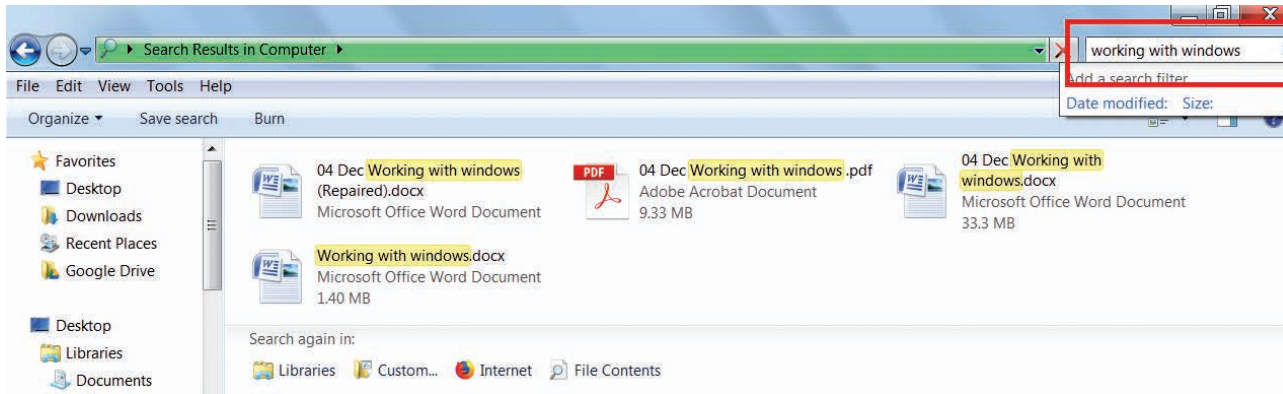

Figure 5.24. Finding a File/Folder in the Computer icon screen

- Just click and open that file or the folder.

### Workshop

- Find the file created in Workshop-3 using the above procedure

#### 5.11.3. Opening existing Files or Folders

The most common way of opening a file or a Folder is to double click on it.

#### 5.11.4. Renaming Files or Folders

There are number of ways to rename files

or folders. You can rename using the File menu, left mouse button or right mouse button.

#### Method 1

Using the FILE Menu

- Select the File or Folder you wish to Rename.
- Click File→ Rename.
- Type in the new name.
- To finalise the renaming operation, press Enter as in Figure 5.25.

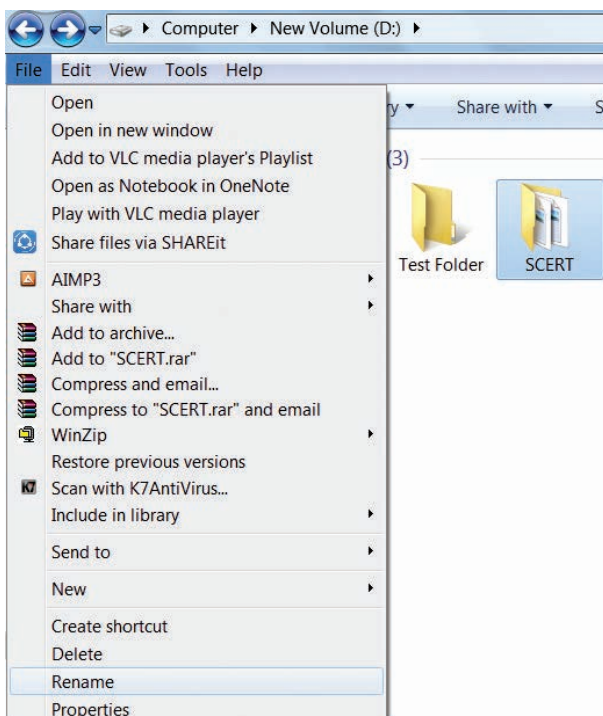

Figure 5.25. Renaming File/Folders using the File menu

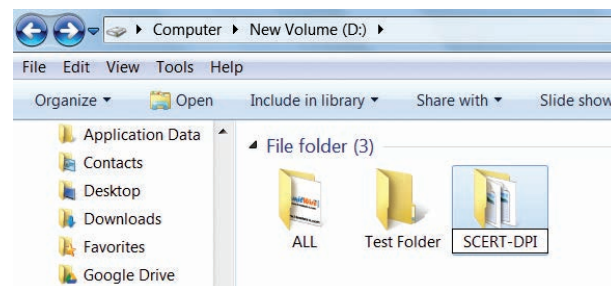

Figure 5.26. Folder renamed

Figure 5.26, you can see that the folder is renamed as SCERT-DPI from SCERT.

#### Method 2

Using the Right Mouse Button

- Select the file or folder you wish to rename.
- Click the right mouse button over the file or folder. (Figure 5.27)
- Select Rename from the pop-up menu.

4. Type in the new name.
5. To finalise the renaming operation, press Enter.
6. Figure 5.29. Shows that the folder "New Folder" is renamed as C++.

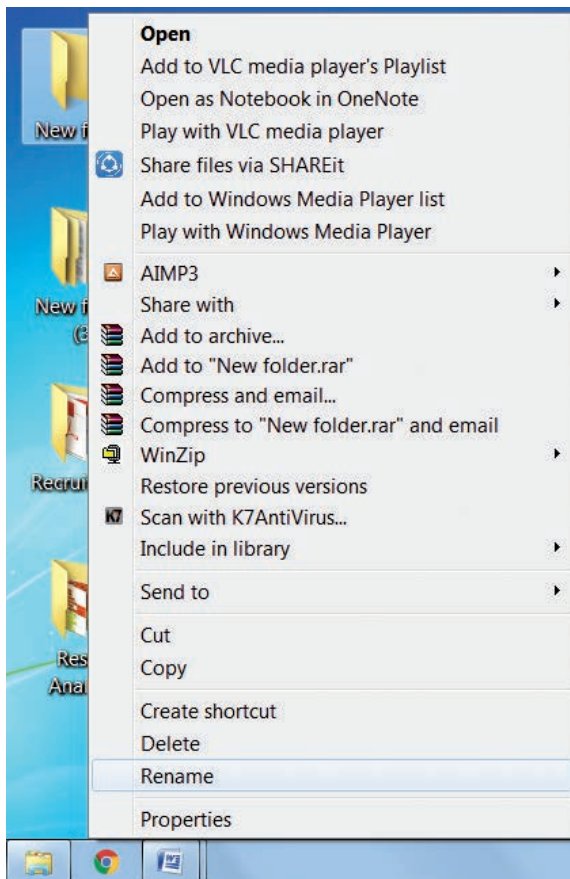

Figure 5.27. Renaming File/Folders using the Right Mouse Button

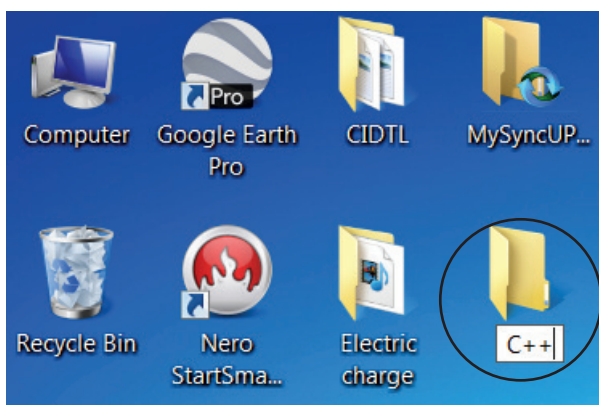

Figure 5.28. New Folder is renamed as C++

### Method 3

Using the Left Mouse Button

1. Select the file or folder you wish to rename.

2. Press F2 or click over the file or folder. A surrounding rectangle will appear around the name.
3. Type in the new name.
4. To finalise the renaming operation, press Enter.

### Workshop

5. Rename the file created by you using the File menu, left mouse button or right mouse button.

### 5.11.5. Moving/Copying Files and Folders

You can move your files or folders to other areas using variety of methods.

#### Moving Files and Folders

##### Method I-CUT and PASTE

To move a file or folder, first select the file or folder and then choose one of the following:

- Click on the **Edit** → **Cut** or **Ctrl + X** Or right **click** → **cut** from the pop-up menu.
- To move the file(s) or folder(s) in the new location, navigate to the new location and paste it using Click **Edit** → **Paste** from edit menu or **Ctrl + V** using keyboard.
- Or Right **click** → **Paste** from the pop-up menu. The file will be pasted in the new location.

##### Method II – Drag and Drop

In the disk drive window, we have two panes called left and right panes. In the left pane, the files or folders are displayed like a tree structure. In the right pane, the files inside the specific folders in the left pane are displayed with various options.

- In the right pane of the Disk drive window, select the file or folder you want to move.
- Click and drag the selected file or folder from the right pane, to the folder list on the left pane.
- Release the mouse button when the target folder is highlighted (active).
- Your file or folder will now appear in the new area. Figure 5.29 shows how to move files or folders using drag and drop method.

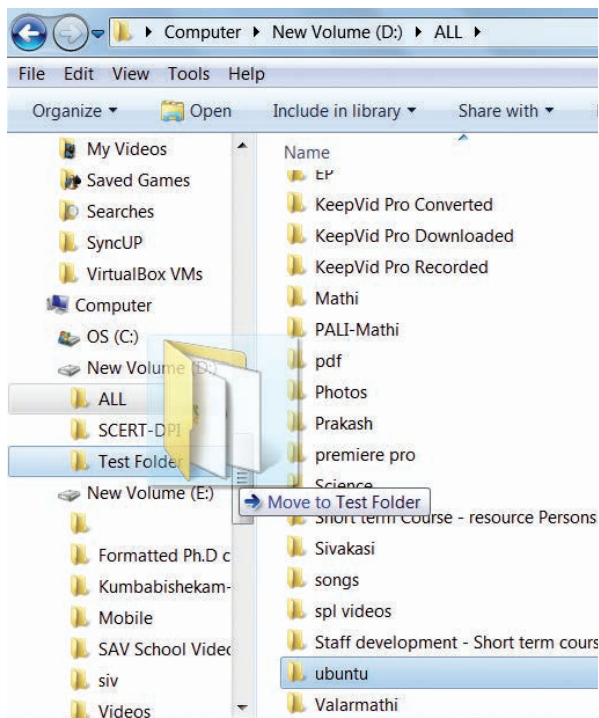

Figure 5.29. Moving the File/  
Folder using drag and drop

### Copying Files and Folders

There are variety of ways to copy files and folders:

#### Method I - COPY and PASTE

To copy a file or folder, first select the file or folder and then choose one of the following:

- Click **Edit** → **Copy** or **Ctrl + C** or **right click** → **Copy** from the pop-up menu.

- To paste the file(s) or folder(s) in the new location, navigate to the target location then do one of the following:
- Click **Edit** → **Paste** or **Ctrl + V**.
- Or **Right click** → **Paste** from the pop-up menu.

#### Method II - Drag and Drop

- In the RIGHT pane, select the file or folder you want to copy.
- Click and drag the selected file and/or folder to the folder list on the left, and drop it where you want to copy the file and/or folder.
- Your file(s) and folder(s) will now appear in the new area.

#### Note

If you want to select multiple files or folders, use **Ctrl + Click**.

### 5.11.6. Copying Files and Folders to removable disk

There are several methods of transferring files to or from a removable disk.

- Copy and Paste
- Send To

#### METHOD I - Copy and Paste

- Plug the USB flash drive directly into an available USB port.
- If the USB flash drive or external drive folder does NOT open automatically, follow these steps:
- Click Start → Computer. (Figure 5.31)

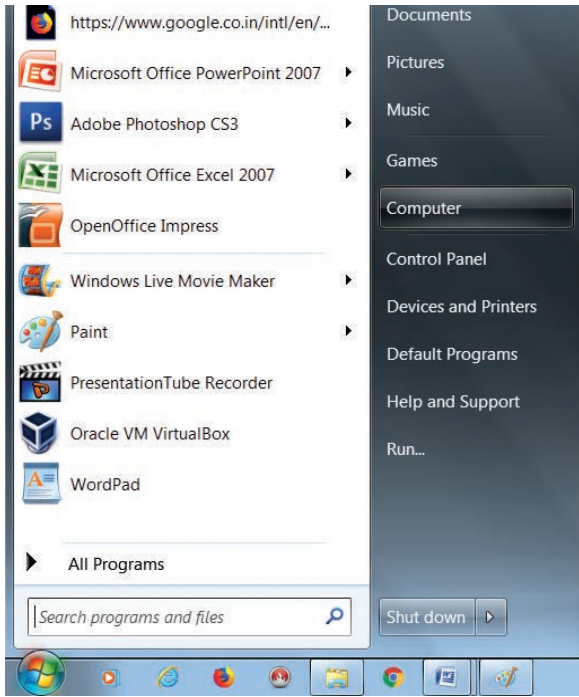

Figure 5.30. Selecting Computer option from Start menu

- Double-click on the Removable Disk associated with the USB flash drive. (Figure 5.31)

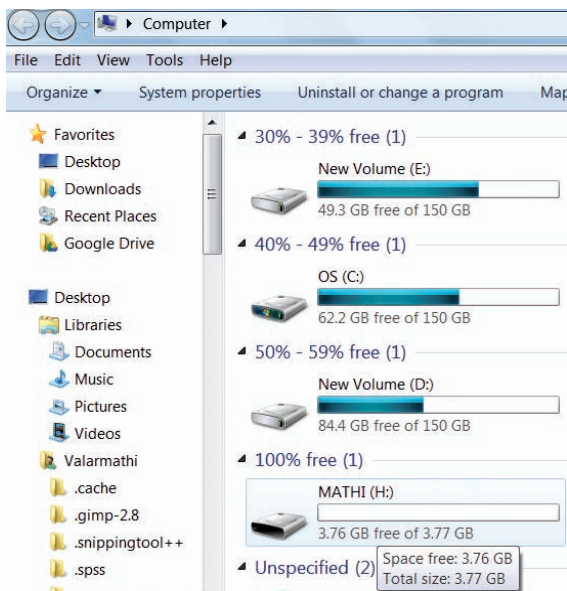

Figure 5.31. Double Clicking Removable Disk

- Navigate to the folders in your computer containing files you want to transfer.

Right-click on the file you want to copy, then select **Copy**. (Figure 5.32)

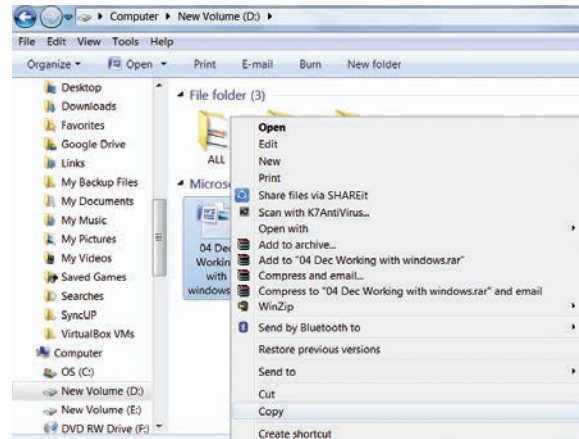

Figure 5.32. Copying File using right click

- Return to the Removable Disk window, right-click within the window, then select **Paste**. (Figure 5.33)

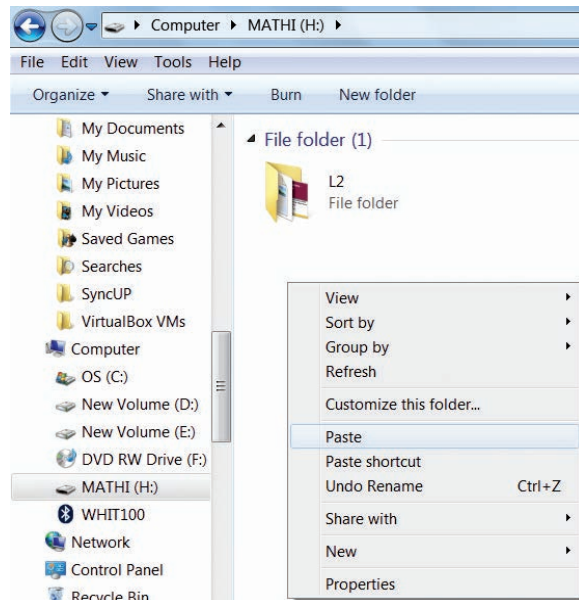

Figure 5.33. Pasting File using right click

### METHOD II - Send To

- Plug the USB flash drive directly into an available USB port.
- Navigate to the folders in your computer containing files you want to transfer.
- Right-click on the file you want to transfer to your removable disk.
- Click **Send To** and select the Removable Disk associated with the USB flash drive. (Figure 5.34)

### Workshop

6. ♦ Move the file created by you in My Documents to Drive D.
  - ♦ Copy the file created by you from drive D: to a removable disk.

#### 5.11.7. Deleting Files and Folders

- When you delete a file or folder, it will move into the Recycle Bin.

#### To delete a file or folder:

Select the file or folder you wish to delete.

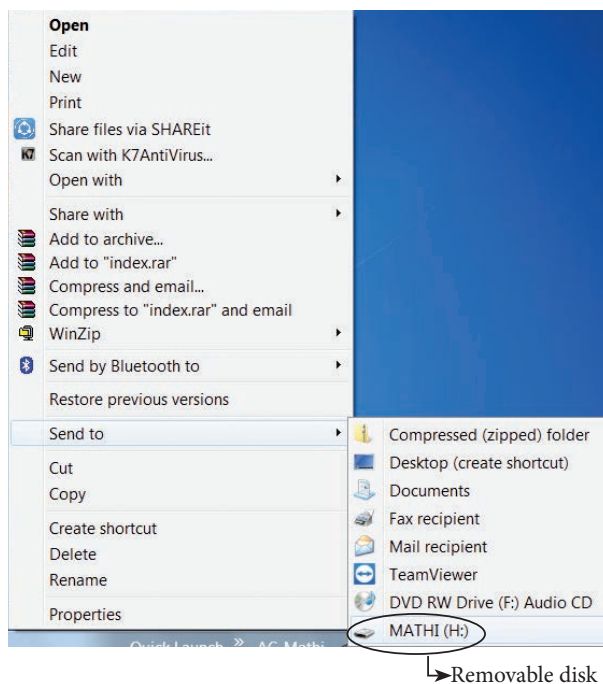

Figure 5.34. Copying File using Send to option

1. Right- click the file or folder, select **Delete** option from the po-pup menu or Click **File** → **Delete** or press **Delete** key from the keyboard.
2. The file will be deleted and moved to the Recycle bin.

### Workshop

7. Delete the file created by you after duplicating the same under My Documents.

#### Note

To permanently delete a file or folder (i.e. to avoid sending a file or folder to the Recycle Bin), hold down the SHIFT key, and press **delete** on the keyboard.

#### Recycle Bin

Recycle bin is a special folder to keep the files or folders deleted by the user, which means you still have an opportunity to recover them. The user cannot access the files or folders available in the Recycle bin without restoring it. To restore file or folder from the Recycle Bin

- *Open Recycle bin.*
- Right click on a file or folder to be restored and select **Restore** option from the pop-up menu.
- To restore multiple files or folders, select **Restore all items.**
- To delete all files in the Recycle bin, select **Empty the Recycle Bin.**

#### 5.12. Creating Shortcuts on the Desktop

Shortcuts to your most often used folders and files may be created and placed on the Desktop to help automate your work.

- Select the file or folder that you wish to have as a shortcut on the Desktop.
- Right click on the file or folder.
- Select **Send to** from the shortcut menu, then select **Desktop (create shortcut)** from the sub-menu.
- A shortcut for the file or folder will now appear on your desktop and you can open it from the desktop in the same way as any other icon. Figure 5.36.

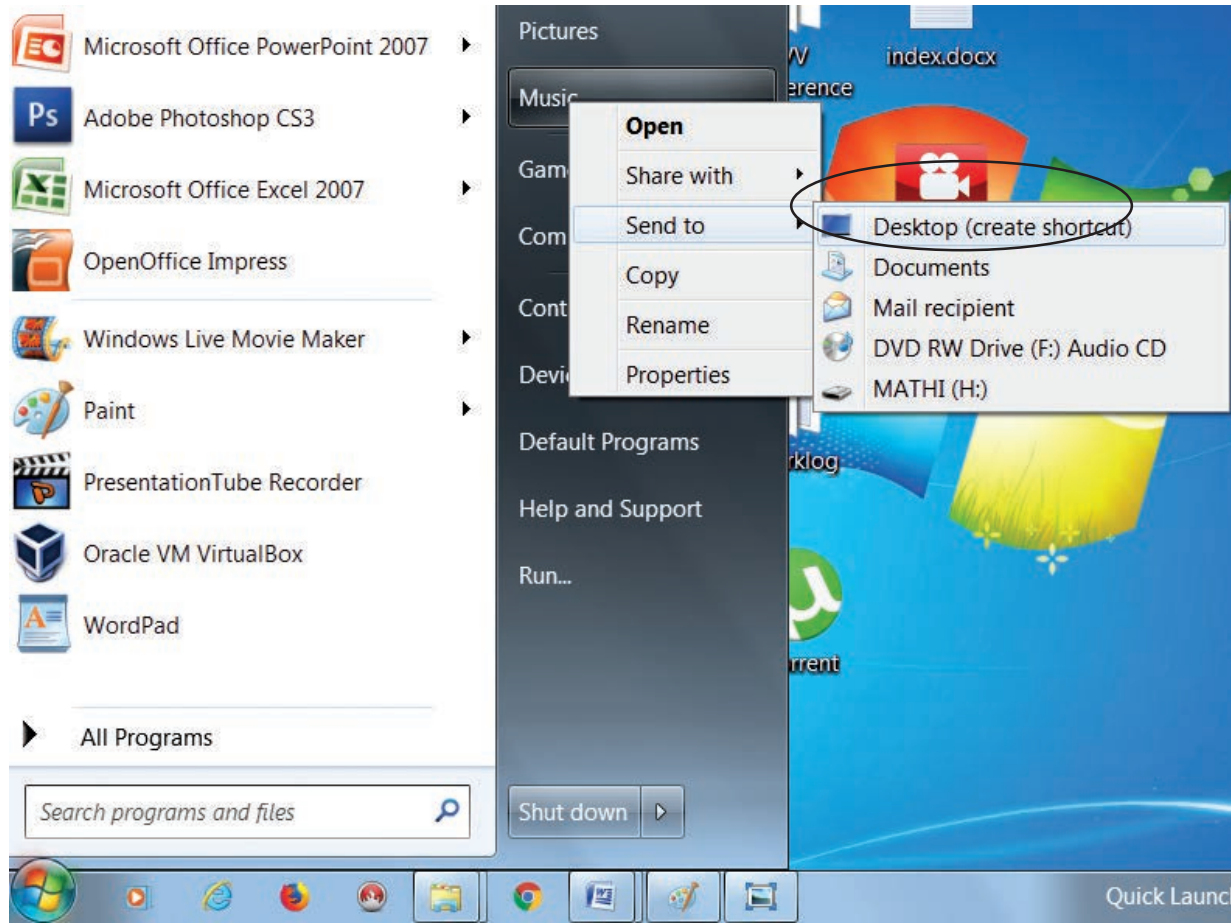

Figure 5.35 Creating Shortcut

### 5.13. Shutting down or Logging off a Computer

Once you have closed all open applications, you can either log off your computer or shut down the computer.

#### Log Off

To Log off/Shut down the computer:

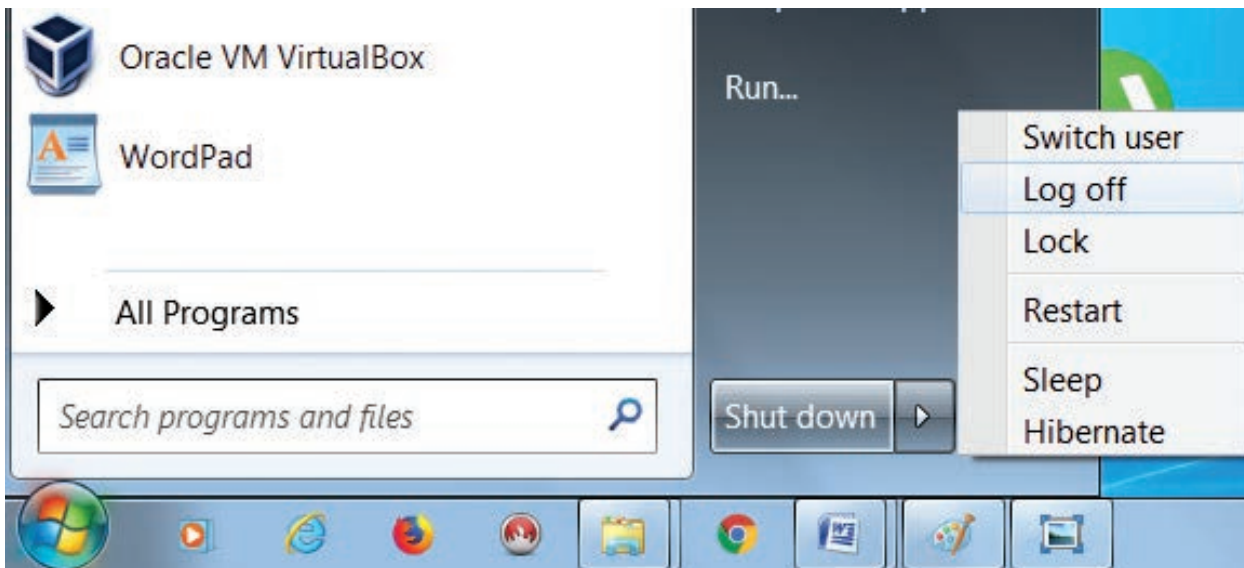

Figure 5.36. Log off option

- Click **start** → **log off** (click the arrow next to Shut down) or **Start** → **Shutdown** (Figure 5.37)
- If you have any open programs, then you will be asked to close them or windows will Force shut down, you will lose any un-saved information if you do this.
- **Switch User:** Switch to another user account on the computer without closing your open programs and Windows processes.
- **Log Off:** Switch to another user account on the computer after closing all your open programs and Windows processes.
- **Lock:** Lock the computer while you're away from it.
- **Restart:** Reboot the computer. (This option is often required as part of installing new software or Windows update.)
- **Sleep:** Puts the computer into a low-power mode that retains all running programs and open Windows in computer memory for a super-quick restart.
- **Hibernate** (found only on laptop computers): Puts the computer into a low-power mode after saving all running programs and open Wwindows on the machine's hard drive for a quick restart.

### Activity



#### Student Activity

1. Create files and folders using Windows and Ubuntu and compare them.
2. Create a File/Folder in Windows 7, Windows 8 and Windows 10. Prepare a report on the differences you face while creating the same.

## Evaluation



### Part – I

#### Choose the correct answer

1. From the options given below, choose the operations managed by the operating system.
 
  - a. Memory
  - b. Processes
  - c. Disks and I/O devices
  - d. all of the above
2. Which is the default folder for many Windows Applications to save your file?
  - a. My Document
  - b. My Pictures
  - c. Documents and Settings
  - d. My Computer
3. Under which of the following OS, the option Shift + Delete – permanently deletes a file or folder?
 

a. Windows 7	b. MS-DOS
c. Linux	d. Android OS
4. What is the meaning of "Hibernate" in Windows XP/Windows 7?
  - a. Restart the Computer in safe mode
  - b. Restart the Computer in hibernate mode
  - c. Shutdown the Computer terminating all the running applications
  - d. Shutdown the Computer without closing the running applications
5. The shortcut key used to rename a file in windows
 

a. F2	b.F4
c.F5	d. F6

**Part – II****Very Short Answers**

1. What is known as Multitasking?
2. What are called standard icons
3. Differentiate Files and Folders.
4. Differentiate Save and save As option.
5. How will you Rename a File?

**Part-III****Short Answers**

1. What are the functions of Windows Operating system.

2. Write a note on Recycle bin.
3. Write a note on the elements of a window.
4. Write the two ways to create a new folder.
5. Differentiate copy and move

**Part-IV****Explain in Detail**

1. Explain the versions of Windows Operating System.
2. Explain the different ways of finding a file or Folder
3. Write the procedure to create shortcut in Windows OS.



A-Z  
**GLOSSARY**

<b>Operating System (OS)</b>	System software that enables the hardware to communicate and operate with other software.
<b>Mouse</b>	Handheld hardware input device that control a cursor in a GUI and can move and select text, icons, files, and folders.
<b>Windows</b>	Familiar operating system developed by Microsoft corpn.
<b>Desktop</b>	Opening screen of windows operating system.
<b>Icon</b>	Tiny image represent a command.
<b>Folder</b>	Container of files
<b>Linux</b>	An operating system.



## Part - I : Introduction to Word Processor



## Learning Objectives

- To understand the importance of a word processor.
- To understand this application in Open Office.
- To understand working of OpenOffice writer in Windows OS.
- To know the editing options in OpenOffice writer.
- To know the text formatting and page formatting options in OpenOffice writer.
- To know the use of spell check features of OpenOffice writer.



Table 6.1 - Proprietary Software &amp; Open Source Software

Proprietary source Word processing software	
Package	Developer
Microsoft Word	Microsoft Corporation
WPS Word	Kingsoft
WordPro	Lotus Corporation
Open Source Word processing software	
Package	Developer
OpenOffice Writer	Apache
LibreOffice Writer	The document foundation
Abiword	Abisource

## Tamil Word Processors

Tamil openoffice writer, Tamil LibreOffice Writer, Kamban 3.0, Mentamizh2017 – These are familiar word processors exclusively for Tamil Language. Microsoft also provides full Tamil interface for all office suits.

In this chapter, you are going to learn about an word processor (OpenOffice Writer).

## 6.2 An Introduction to OpenOffice Writer

OpenOffice is the leading open-source office software suite for word

## 6.1 Introduction to Word Processor

Word processor is a computer software to create, edit, manipulate, transmit, store and retrieve a text document. The above said activities are called as “Word Processing”. In other words, Word processing is an activity carried out by a computer with suitable software to create, edit, manipulate, transmit, store and retrieve text documents.

There are many word processing software available as proprietary source as well as open source. The familiar word processing packages are given in the following Table.

processing, spreadsheets, presentations, graphics, databases and much more. It is available in many languages and works on all computers. It stores all data in an International open standard format and can also read and write files from common office software packages. OpenOffice is easy to learn.

OpenOffice is a productive office suite with a collection of different software packages such as

- OpenOffice Writer - Word Processor to create text documents
- OpenOffice Calc - Spreadsheet to create worksheets
- OpenOffice Base - Database
- OpenOffice Impress - Presentation software
- OpenOffice Draw - Drawing Software
- OpenOffice Formula - Create formula and equations

OpenOffice Writer is the word processor component of OpenOffice. In addition to the usual features of a word processor (spelling check, thesaurus, hyphenation, autocorrect, find and replace, automatic generation of table of contents and indexes, mail merge and others), Writer provides these important features:

- Templates and styles.
- Page layout methods, including frames, columns, and tables.
- Embedding or linking of graphics, spreadsheets, and other objects.
- Built-in drawing tools.
- Master documents-to group a collection of documents into a single document.

- Change tracking during revisions.
- Database integration, including a bibliography database.
- Export to PDF.

### 6.2.1 Download and Install openoffice

Download and Install the latest version of OpenOffice suite from <http://www.openoffice.org/download> at free of cost.

### 6.2.2 Creating a new document in OpenOffice Writer

A new OpenOffice Writer document can be created by various methods. From Windows, select Start → All Programs → OpenOffice → OpenOffice Writer (or)

From Star Center (Welcome Screen):

- Double-click on “OpenOffice” icon on the desktop
- Now, a welcome screen appears as shown in **Figure 6.1**



Figure 6.1 Opening Screen (Star Center) of OpenOffice

The opening screen is called as “Star Center”. Writer is one of the components of OpenOffice. So, it may be invoked from the “Star Center” by simply clicking on the “Text Document” icon. (or)

A new text document can also be created by selecting **File** → **New** → **Text Document** from any OpenOffice

Application. **Ctrl + N** keyboard short cut can also be used to open a new text document as shown in the **Figure 6.2**

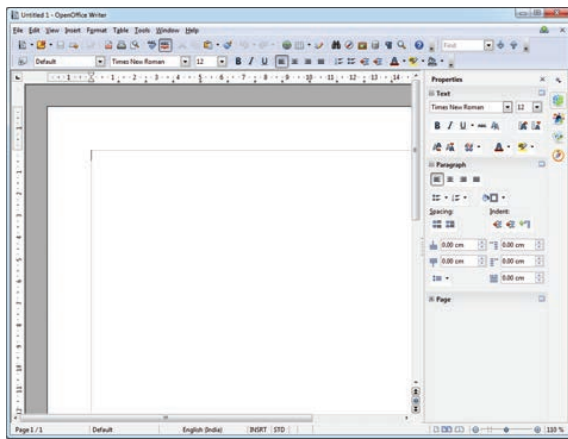

Figure 6.2 A new OpenOffice Writer Window

**6.2.3 Parts of Writer Window:**

The Figure 6.3 displays the contents of OpenOffice Writer window such as Title bar, Menu bar, Standard Toolbar, Formatting Tool bar, Ruler, Work space and Status bar. The components of a OpenOffice Writer window are explained below in Figure 6.3.

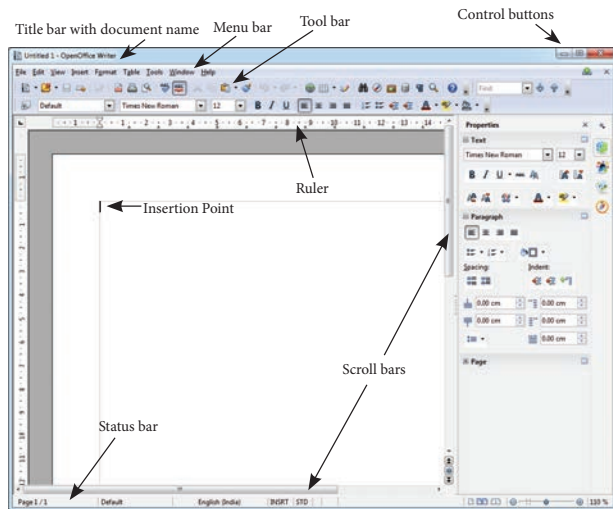

Figure 6.3 Components of Writer Window

**Title Bar**

The title bar is displayed at the top of the window, which displays the name

**Control Buttons:**

of the document and its application. By default, the document is given the name as Untitled1.

At the right corner of title bar the control buttons available: (1) minimize, (2) maximize/restore and (3) close shown in Figure 6.4

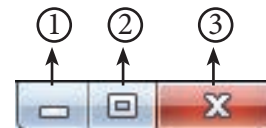

Figure 6.4 Control Buttons

**(1) Minimize button:**

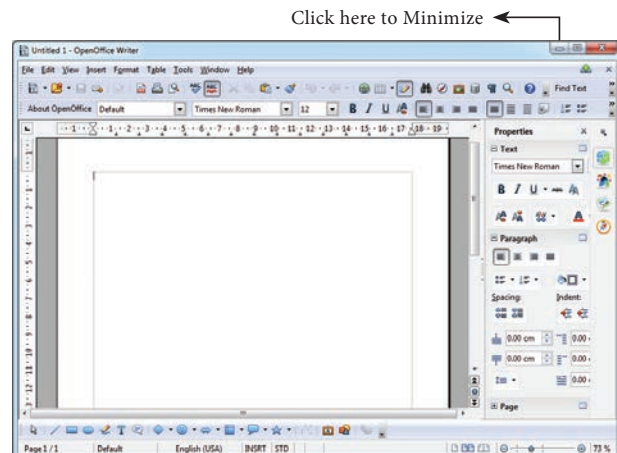

Figure 6.5 - Window Showing Minimize button

When you click minimize button, it shrinks your document window smaller in size and shows it as a small button on the task bar. To restore it in its original size, place your mouse pointer on the OpenOffice button which is available in the Taskbar, you can view your document as miniature and when you click on the button, your document is restored to its original size.

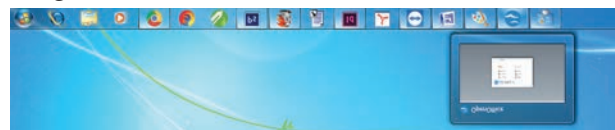

Figure 6.6 - Miniature Window of Open Office Document

### (2) Maximize button :

When you click maximize button, your document window is displayed in full screen. When it is in full screen, the maximize button is changed to “Restore”.

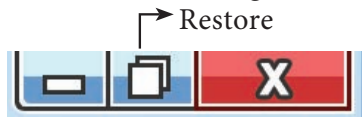

Figure 6.7 - Sizing Buttons

When you click restore button, the document window regains to its original size.

### (3) Close button :

This button is called as “Close” button, when you click this button, the application is closed and OpenOffice returns back to the desktop. The red colored close button may also be called as “Exit” or “Quit”.

Exit / Close openoffice



Close document

Figure 6.8 - Close Button

There is another X mark on the right most corner of the menu bar. This is actually used to close your document. When you click this X mark, your document will be closed, OpenOffice will continue to be in open condition.

### Menu Bar

The menu bar is below the title bar which comprises of various menus consisting of various options.

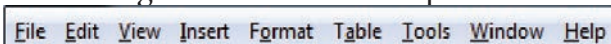

Figure 6.9 - Menu Bar

**File** – The File menu contains various options for file management tasks

such as: New, Open, Close, Save, Save As, Print, Export etc.

**Edit** –The Edit menu contains cut, copy, paste, Undo, Redo etc.

**View** –The View menu contains the options that used to modify the environment of Writer such as display of toolbars, web layout, print layout, navigator etc.

**Insert** – The Insert menu contains commands for inserting various elements such as pictures, tables, charts, comments, headers, footers, special characters etc.

**Format** – The Format menu contains the options of various text and page formatting features like page size, layout, font characteristics, bullets and numbering etc.

**Tables**– The Tables menu contains various tools to manage and manipulate tables such as to create a table, insert rows, insert columns, split cells, merge cells etc.

**Tools** – The Tools menu contains various tools and functions such as spell check, macros, mail merge, end notes/ footnotes etc.

**Window**– The window menu shows display options such as New Window, Close Windows, Split and Freeze.

**Help** – The Help menu displays the inbuilt help features in OpenOffice.

### Tool Bar:

Under the menu bar, there are two toolbars available by default. They are:

#### (1) Standard Toolbar

#### (2) Formatting Toolbar

**Standard Tool Bar**– This tool bar is just below the menu bar which consists of shortcut icons for frequently performed

tasks. There are many shortcut icons like cut, copy, paste, undo etc...

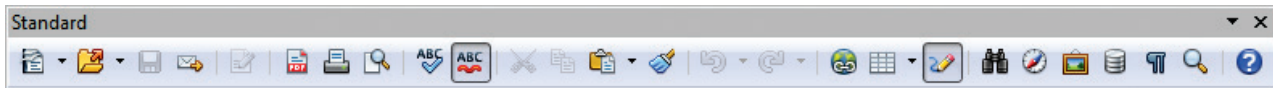

Figure 6.10- Standard Toolbar

**Formatting Tool Bar**– The formatting tool bar is below the standard tool bar which consists of icons used for formatting the text like bold, underline, italics, font type, font color etc.



Figure 6.11- Formatting Toolbar

## Ruler

The ruler is a scale below the formatting tool bar which shows the margins. There are two set of rulers (1) Horizontal ruler and (2) Vertical ruler. Horizontal ruler is used to set left and right margins of a page and vertical ruler for top and bottom setting.



Figure 6.12 - Ruler

## Work Space

The work space is the blank area which is used to type the content of the file. A flashing vertical bar that appears at the beginning of the screen which is called as “Insertion pointer”.

## Status Bar

The status bar is at the bottom of the window which shows the current status of the document such as number of pages, current page number, default language etc.

### 6.2.4 Entering the Text

Once a new document is opened, the text can be typed in the blank area of the screen. As the text is typed they appear on the screen and the **flashing vertical bar called the insertion pointer** moves to the right. When the text reaches the end of the line, the word is automatically wrapped to the next line. This feature in any word processor is known as “**Word Wrap**”.

The **Enter** key must not be pressed at the end of the each line. The **Enter** key should be pressed only at the end of a paragraph or when a blank line is to be inserted. When a page is filled up, OpenOffice Writer automatically creates a new page.

### 6.2.5 Moving within a document

There are different ways of moving within a document. The shortcut keys given in Table 6.2 are used to move easily within a document.

Table 6.2 Keyboard shortcut Keys

KEY	ACTION
→	To move a character right
←	To move a character left
↑	To move one line up
↓	To move one line down
Ctrl + →	One word right
Ctrl + ←	One word left

Ctrl + ↑	One paragraph up
Ctrl + ↓	One paragraph down
Home	To the beginning of line
End	To the end of line
Ctrl + Home	To the beginning of document
Ctrl + End	To the end of document
Tab	To move one cell to right
Shift + Tab	To move one cell to left
Pg up(Page Up)	To scroll one screen up
Pg Down(Page Down)	To scroll one screen down

### 6.2.6 Saving the Document

The first time the document is saved, OpenOffice Writer prompts for a name. Naming the file enables the user to find and open that file again. One can select the drive and folder where the file will be stored. To save a document for a first time, the following steps are used:

- Click **File** → **Save** → (or) **File** → **Save As** (or) **Ctrl + S**
- The “**Save As**” dialog box appears as on Figure 6.13.

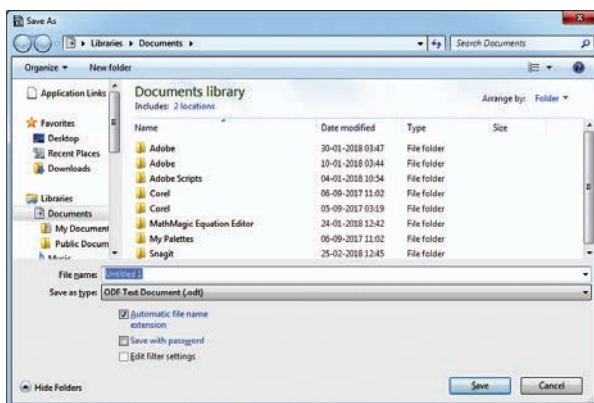

Figure 6.13 Save As dialog box

- Select location to store your document. The default location to store all documents is “Documents” folder in Windows.
- Type your document name in the **File Name** box.
- All documents in OpenOffice Writer will be stored with **.odt** extension. You can store your OpenOffice document as Microsoft Word document or pdf. To do so, select file type from **Save as type** list box. This list box shows variety of formats to be saved.
- Finally, Click “**Save**” button.
- Once the file is saved, your document name will be displayed on the title bar.

### Saving with password



Figure 6.14 – Password dialog box

In OpenOffice Writer, a document can be protected with a password. You can set a password to protect your document

while saving a file. To save a file with password, click on “**Save with Password**” check box in Figure 6.1.3 and then click “**Save**” button. Immediately it shows “Set Password” dialog box as shown in the Figure 6.14.

In this dialog box, Enter a password in “**Enter Password to open**” text box and retype the same password in “**Confirm Password**” box for confirmation. Finally click “**OK**” button.

“**More Options**” button in Figure 6.14 provides some more features to your protected document such as “Read only” and change password.

### 6.2.7 Closing a Document

After your document is saved, it is still open. So, you can continue typing your document. When the work is finished, you should save the document and then close document using *File* → *Close* command (or) Press *Ctrl + W*.

#### Closing Unsaved Document:

When you close an unsaved file using the close control button, Writer shows a warning message as shown in Figure 6.15.

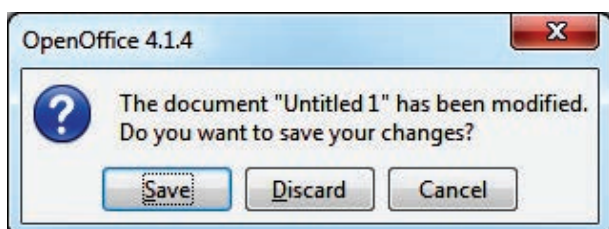

Figure 6.15 Alert Message box

If you accept the warning message, click the “**Save**” button. When you click

the “**Save**” button, it proceeds to save the file. If you are not willing to save the file, then click “**Discard**”, or if you want to cancel this warning and continue working in the same document, click “**Cancel**”.

### 6.2.8 Opening an existing document

Once a document is saved, it can be opened at any time. To open an existing document, Click on the *File* → *Open* or *Ctrl + O*, the Open dialog box appears, enter the name of the file in the File Name text box and click the **OPEN** button as in Figure 6.16.

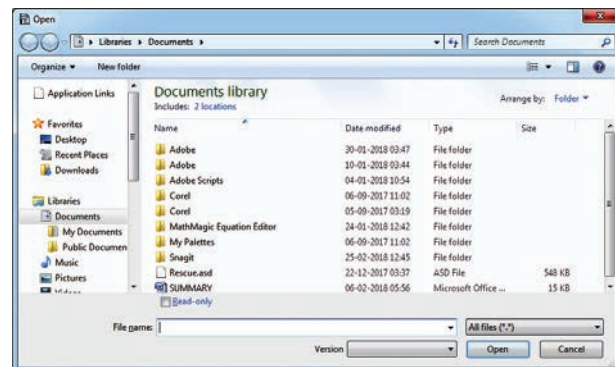

Figure 6.16 – Open dialog box

## 6.3 Tamil Typing Interface

Typing in Tamil has different methods.

- Using Tamil Font
- Using Tamil Interface.

In the first method specific Tamil fonts are available which has to be downloaded and installed and should be included in the **font folder** of the control panel. But this method has some drawbacks:

- The user must be aware of Tamil typing.
- The particular font must be available in the system.
- It does not support other languages including English.

- The computer accepts characters as symbols not as language.
- It is not portable, i.e. if the document is sent to another computer, if the same font is not available, it is recognized as symbols not as original characters.

To overcome the drawbacks in the first method, the interface method provides the following advantages:

- It follows Unicode technique. Hence knowledge of Tamil typing is not necessary.
- It is easy to type documents in Tamil in any word processor.
- Some of the Unicode fonts like “**Arial Unicode**” supports all Indian languages including Tamil and English using respective language interface.

### 6.3.1 Download and Install Tamil Typing Interface

Many Tamil Typing Interfaces are available as open source such as “Murasu”(it is exclusively for Tamil), “NHM Writer”(It is universal to all Indian languages) etc.

**To download and install:**

- “Murasu” use the link : <http://anjal.net/download>
- “NHM writer” use the link : <http://software.nhm.in>

### 6.4 Editing a document

Once a document is typed, it can be edited in many ways. If there is some insertions or deletions, it can be done while typing or after typing also. Corrections can be made in two different ways :

**Backspace Key:** Deletes the character to the left of the insertion pointer.

**Delete Key :** Deletes the character

to the right of the insertion pointer

To insert a text in between if something is left out, the insertion can be made by taking the insertion pointer to the current location and Press the Insert key the newly typed text is inserted, so that the existing text moves to the right. This is **Insert mode**. Press the Insert key again, the text is over written on the existing text. This is called **Type over mode**. You can toggle between the insert mode and type over mode by pressing the **Insert key**.

## 6.5 Select, Move and Copy text

### 6.5.1 Selecting Text

In any word processor, the text has to be selected for performing any operations like copying, moving, formatting etc. The text selection can be done in two methods:

- Selecting the continuous text.
- Selecting the non continuous text.

#### Selecting the continuous text

To select the text continuously move the insertion pointer to the beginning of the text.

- hold the **SHIFT key** and drag the mouse across until the required text is selected and then release the SHIFT key.
- The selected text can be used for any operation.

#### Selecting the non continuous text

To select the text not continuous, move the insertion pointer to the beginning of the text,

- hold the **CTRL key** and drag across the required text to be selected and release the CTRL key
- The required text is selected and can be used for any operation



### Selection using other methods:

#### Selection using Mouse:

To select the text using mouse:

- i) Move the insertion pointer to the beginning of the text
- ii) Hold down the **Left mouse** button and drag it across the text
- iii) Release the mouse button when the required portion of text is selected
- iv) The selected text will be highlighted.

#### Selection using Keyboard:+

To select the text using keyboard:

- i) Move the insertion pointer to the beginning of the text
- ii) Hold the **Shift** key and use the **movement keys** to drag across the required portion.
- iii) when the required portion is selected release the **Shift** key
- iv) The selected text will be highlighted.

#### Selection using Shortcut keys:

Shortcut keys help to select the text quickly and easily.

- To select a word - **Double click** on the word
- To select the entire document - Press **Ctrl + A**

### 6.5.2 Moving and Coping text

#### Moving text

To move a text from one location to another



- Select the text to be moved
- Click **Ctrl + X** or **Cut Icon**  or **Edit → Cut**
- The text is removed from the source location and placed in the clipboard
- Take the insertion pointer to the new location to be moved and

- Click **Ctrl + V** or **Paste Icon**  or **Edit → Paste**

The required text is moved to the new location.

#### Coping text





To copy a text from one location to another

- select the text to be copied
- Click **Ctrl + C** or **Copy Icon**  or **Edit → Copy**
- A duplicate copy of the text is made and sent to the clipboard
- Take the insertion pointer to the new location to be copied and
- Click **Ctrl + V** or **Paste Icon**  or **Edit → Paste**

The required text is copied to the new location.

The Editing shortcut keys are as given in Table 6.3

**Table 6.3 - Cut, Copy and Paste Icons and Shortcuts**

Operation	Action	Icons	Shortcut Key
CUT	Cuts the selected text		Ctrl +X
COPY	To make a duplication of the text.		Ctrl +C
PASTE	To paste the text to a new location after cut or copy process.		Ctrl +V
UNDO	Cancels the previous operation that was performed		Ctrl +Z

### 6.5.3 Paste Special

When you move or copy selected text, the **Paste** option is used to send the information as a whole. But, to move or copy only some aspects of the data, like only its **formatting** or only **value**, the **Paste Special** option is used.

To use **Paste special** option, select the text and apply move or copy, then at the destination location,

- Click **Edit** → **Paste Special** (or) press **Ctrl+Shift+V**, or **Alt+E+S** the Paste Special dialog box opens as shown in Figure 6.17.
- The Paste Special menu varies depending upon the origin and formatting of the text (or object) to be pasted.
- Select **DDE (Dynamic Data Exchange)** link from the Paste special dialog box.

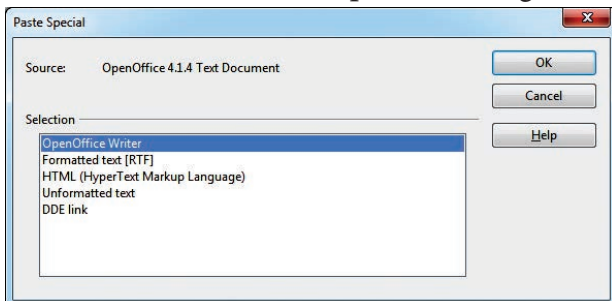

Figure 6.17 - Paste Special dialog box

- Select the type of application and click the **OK** button.
- The copied data is pasted into the document with a **link**.

#### Note

**Dynamic Data Exchange (DDE)** is a mechanism whereby the source data can be pasted into the destination as a **linked, 'live' copy** of the original. Any changes made in the source will immediately reflect in the destination.

### 6.6 Help System in Writer

Open Office Writer provides several forms of help. By pressing **F1** or select **Help** from the menu bar the help window appears as shown in Figure 6.18.

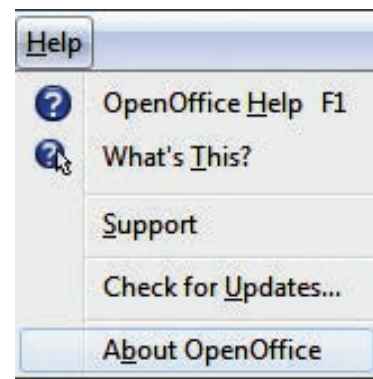

Figure 6.18 – Help window

- To activate tooltips, extended tips, and the help Agent, click **Tools** → **Options** → **OpenOffice**
- For a more detailed explanation, select **Help** → **What's This?** and hold the mouse pointer over the icon where you want more help. Figure 6.19 shows the General settings window

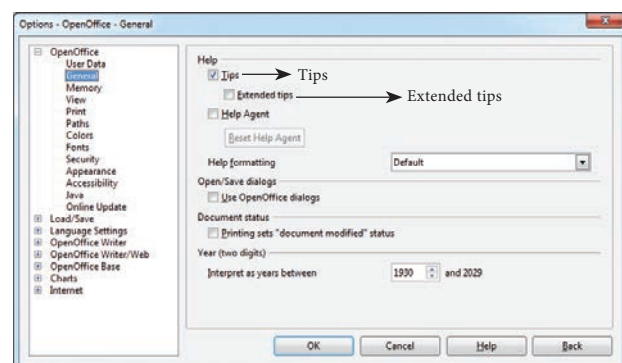

Figure 6.19 - General settings window

## Workshop

### 6.1

- Open a new document in Open office writer.
- Type the following paragraph.

“The ignited minds of the youth is the most powerful resource on the earth. The power of the youth, if properly directed, will bring about transformed humanity by meeting its challenges and bring peace and prosperity.”

- Save and close the document.
- Exit from Open Office Writer.

### 6.2

- Open the document created in Workshop-6.1.
- Append the following paragraph.

“We are as young as our faith and as old as our doubts. We are also as young as our self-confidence and as old as our fears. We are as young as our hopes and as old as our despairs”.

- Save the document
- Using Delete or Backspace key remove the last line of the first paragraph.
- Type the following lines after the second paragraph and create it as a new paragraph.

“It doesn’t matter who you are, if you have a and determination to achieve that vision, you will certainly do so.”

- In the third paragraph insert the word “vision” between “a” and “and”.

### 6.3

- Open the document created in workshop-6.1.
- Copy and paste the following words into a new document either using keyboard or mouse shortcuts. (i) Ignited (ii) powerful (iii) humanity (iv) challenges (v) prosperity
- Save the new document
- In the first document, move the following words either using keyboard or mouse shortcuts. (i) Ignited (ii) Challenges (iii) Prosperity

## Part - II : Formatting Text and Paragraph

### 6.7 Text formatting

A text without any special formatting gives a monotonous appearance. OpenOffice Writer offers a number of choices for formatting such as Bold, Italics and defining the font type, and font size. Bold, Italic, underlined are the most common types of text formatting. Almost all the formatting options are available under the **Format** menu.

#### 6.7.1 Changing font style, size and colour

A font is a set of characters in a particular style. Changing the default appearance of the text like changing the font type, size, color, style etc., are called as **Text formatting**. To make the text attractive and more appealing, various formatting like bold, italic and underline can be done by using the following text formatting shortcuts shown in Table 6.4

**Table 6.4 Text formatting shortcuts**

OPERATION	ACTION	ICON	SHORTCUT KEY
BOLD	Makes the text bold	<b>B</b>	Ctrl + B
ITALICS	Italicizes the text	<i>I</i>	Ctrl +I
UNDERLINE	Underlines the text	<u>U</u>	Ctrl +U

The default font type is **Times New Roman** and the type of font can be changed by clicking on the **Font Type icon**

Times New Roman ▼

The default size of font is **12 points** which can be changed by clicking on the **Font Size icon** 12 ▼

The default font color is **black** and the font color can be changed by clicking on the **Font colour icon** A ▼ which shows the color palette from which the required color can be selected.

Besides the regular formatting Bold, Italics and underline, many other formatting can be done by using the dialog box shown in Figure 6.20. The other formatting options can be selected by using **Format** → **Character**. The Character dialog box is displayed as shown in the Figure 6.20 using which all the formatting can be done at a single stretch with a preview options.

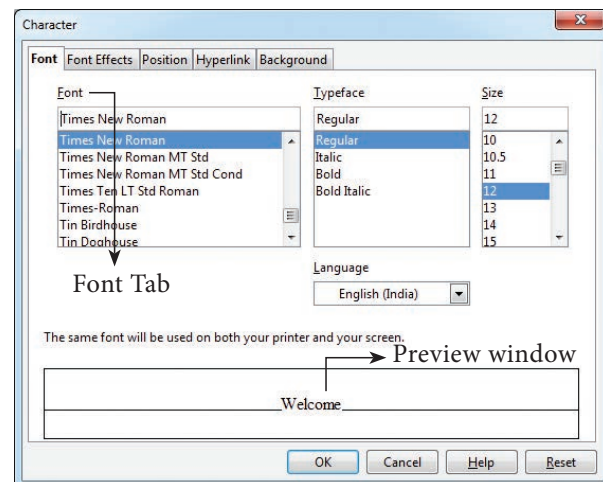

**Figure 6.20 – Character dialog box**

#### 6.7.2 Changing Case

Normally any text can be typed in upper or lower case. The text can be changed to different cases like:

- **Uppercase** (Capital letters)
- **toggle case** (reverse case),
- **sentence case** (first letter of each sentence in capital),
- **Capitalize every word** (first letter of each word in capital),

- **lower case.** (Small letters)

This can be done by:

- Select the required text to change case
- Select **Format** → **Change case**.
- **Select the required options**

### 6.7.3 Highlighting text

Highlighting is used to draw attention to important information in text. Highlighting is beneficial because it first asks the reader to pick out the important parts, and then gives an effective way to review that information later.

Highlighting can be applied by selecting the text and click **Highlighting** icon , the color palette is displayed, select the required color, and the text is highlighted. Highlighting can be removed by selecting the text and click **No Fill** from the color palette.

**DO YOU KNOW?** Highlighting is to draw attention to important or key points in a document for easy reference by marking it in a different color.

### 6.7.4 Clearing the formatting

To clear the formatting applied to the text

- Select the entire document by **Ctrl + A** or **Edit** → **Select All**
- Clear applied formatting by **Ctrl + M**

## 6.8 Paragraph formatting

### 6.8.1 Paragraph Alignment

A paragraph is any text that ends with a hard return. A hard return is accomplished anytime you press the **Enter** key. Paragraph Alignment or justification refers to the way in which the lines of a paragraph are aligned. Paragraph alignment lets you to control

the appearance of individual paragraphs. There are **four** types of alignment available in Open Office Writer - **left** - alignment, **Right** - alignment, **Center** - alignment, and **Justify** - alignment.

**Left-alignment** - A paragraph's text is LEFT aligned when it is aligned evenly along the left margin and uneven along the right margin. This is the default alignment when a paragraph is typed.

**Right-alignment** - A paragraph's text is RIGHT aligned when it is aligned evenly along the right margin and uneven along the left margin.

**Center-alignment**- All the lines in the paragraph are aligned to the center of the page size.

**Justified-alignment** - All the lines in the paragraph, are arranged evenly both on the left and right margins. This is achieved in Writer by automatically inserting additional space between the words.

Paragraph formatting can be applied by **Format** → **Paragraph**, the paragraph dialog box appears as displayed in Figure 6.21.

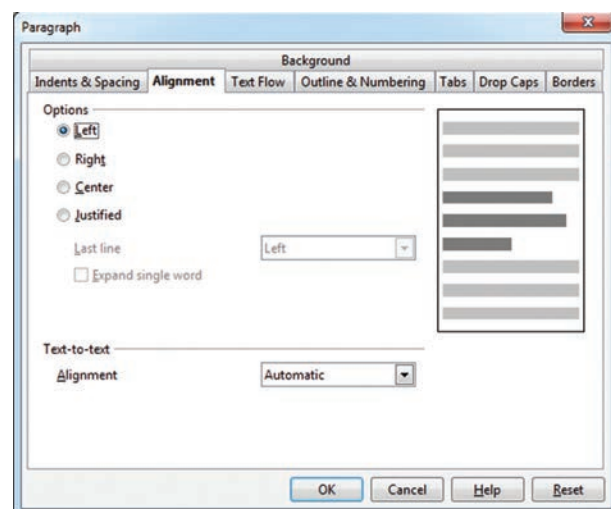

Figure 6.21 – Paragraph dialog box

The paragraph formatting can also be done by icons using the formatting tool bar as shown in Figure 6.22 and shortcut keys as shown in Table 6.5

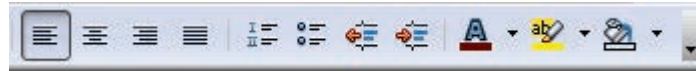

Figure 6.22 Formatting toolbar

Table 6.5 Paragraph Alignment Icons and shortcut Keys

ALIGNMENT	ACTION	ICON	SHORT CUT KEY
LEFT	Align the paragraph with respect to the left margin		Ctrl + L
RIGHT	Align the paragraph with respect to the right margin		Ctrl + R
CENTER	Align the paragraph with respect to the center of the page		Ctrl + E
JUSTIFIED	Align the paragraph with respect to both the left and right margin		Ctrl + J

An example showing all the four paragraph alignment:

#### Left Alignment

All power is with in you take up one idea, make that one idea your life. Think of it dream of it, live on that idea let the brain, muscles, nerves, every part of your body be full of that idea, and just leave every other idea alone. This is the way to success.

#### Right Alignment

All power is with in you take up one idea, make that one idea your life. Think of it dream of it, live on that idea let the brain, muscles, nerves, every part of your body be full of that idea, and just leave every other idea alone. This is the way to success.

#### Center Alignment

All power is with in you take up one idea, make that one idea your life. Think of it dream of it, live on that idea let the brain, muscles, nerves, every part of your body be full of that idea, and just leave every other idea alone. This is the way to success.

#### Justified Alignment

All power is with in you take up one idea, make that one idea your life. Think of it dream of it, live on that idea let the brain, muscles, nerves, every part of your body be full of that idea, and just leave every other idea alone. This is the way to success.

### Example 6.1 Paragraph Alignment

### 6.8.2 Line Spacing:

Line spacing determines the amount of **vertical space** between lines of text in a paragraph. By default, the lines are single-spaced, that is the spacing accommodates the largest font in that line, plus a small amount of extra space. In Open Office, setting line spacing is quite easy through the context menu, select the line or word or phrase, **right-click** → **line spacing**, select the type single, 1.5 or double. There are seven different types of line spacing as shown in the dialog box given below in Fig.6.23.

- Select the entire document by **Edit** → **Select All**
- **Format** → **paragraph**
- The paragraph dialog box appears, click **Indents & Spacing** tab
- In the **line spacing option**, select the type and click **OK** button.

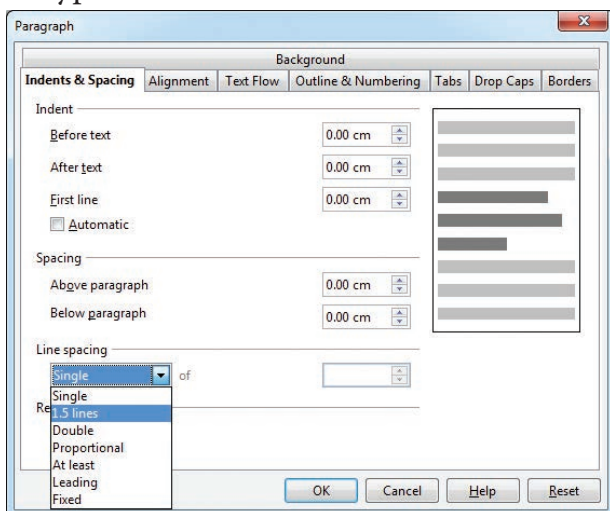

Figure 6.23 Paragraph dialog box

### 6.8.3 Indenting text

Indent is the distance from the left and right margin of a paragraph. It is used to improve the efficiency and readability of the paragraph and makes the paragraph look more attractive. In paragraphs, an easy way to apply indent for the first

line of text can be created by moving the insertion pointer to the beginning of the line and pressing the **tab** key on the keyboard. There are four types of indentations:

- Left Indent
- Right Indent
- First Line Indent
- Hanging Indent.

**Left indent** - The Left indent controls the space between the paragraph and the left margin. This is the default indent. Each click on the **Increase indent** icon moves the paragraph ½ inch away from the left margin.

The left indent can also be applied by **Format** → **Paragraph** → **Indents & Spacing** tab, enter a value in the “**Before text**” spin box as shown Figure 6.23. This results in left indent.

**Right Indent** - The Right indent controls the space between the paragraph and the right margin. Each click on the **decrease indent** icon removes the indent applied by the Increase indent. The Right indent can be applied by using dialog box as shown in Figure 6.23.

Select **Format** → **Paragraph** → **Indents & Spacing** tab, enter a value in “**after text**” spin box. This results in right indent.

**First Line Indent** - This First-Line indentation indents the **first line** of the paragraph. It is the most common way to start a new paragraph.

This indent can be applied by **Format** → **Paragraph** → **Indents & Spacing** tab, select **First line** option in the Figure 6.23, enter a **positive** value which results in first line indent.

**Hanging indent** -This is a special kind of indent where the first line of the paragraph alone hangs outside leaving the rest of the text. To apply Hanging indent, a **negative** value is given in the “**First line**” option of the paragraph dialog box as shown in Figure 6.23.

#### 6.8.4 Bullets and Numbering

Bullets and numbering are used to emphasize list of things and make the list easy to read and follow. It provides an excellent way to segregate, list and organize information to the reader. You can control the appearance, or format a bulleted or numbered list.

**Bullets** – This is a paragraph level attribute that applies a bullet character to the start of the paragraph. In bulleted lists, each paragraph begins with a bullet character. This is suitable when the text has to be presented as a list of items preceded by a bullet symbol and no sequence has to be followed. Bullets are quickly created by clicking on the **Bullet icon** 

**Numbering** – This attribute applies a numeral to the start of the paragraph. Numbering is more suitable when the text has to be presented as a sequence. In numbered list, each paragraph begins with an expression that includes a number or letter and a separator such as a period or parenthesis. The numbers in a numbered list are updated automatically when you add or remove paragraphs in the list. Numbering is quickly created by clicking on the **Numbering icon** 

#### 6.8.5 Style of Bullets and Numbering

The default type of bullet is ( . ) and the default type of numbering is ( 1, 2, 3 .....). The style of bullets and numbering can be changed by applying the following steps:

- Select the text to be bulleted
- **Format** → **Bullets and Numbering**
- Select **Bullets Tab**
- The **Bullets and Numbering** dialog box appears where different styles of bullets are displayed
- Click on the required style
- Click **Ok** button
- The selected text is bulleted.

The bullets and numbering dialog box with the bullets tab is displayed in Figure 6.24.

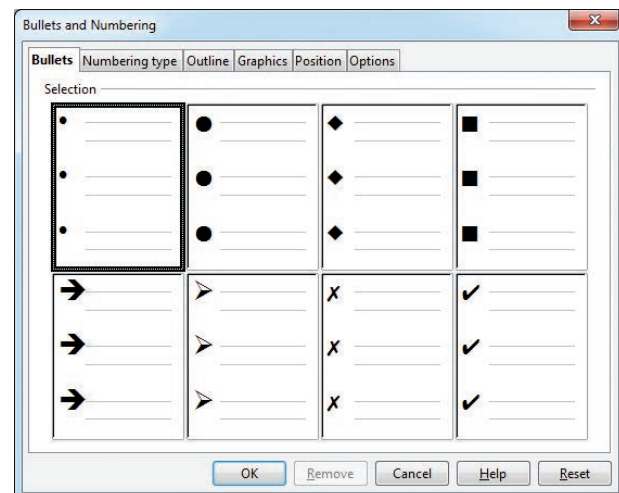

Figure 6.24 Bullets and Numbering dialog box

#### Note

If the text is not typed, then apply the steps above and then type the text, the newly entered text will appear in bulleted form.



### To apply Numbering

1. Select the text to be numbered
2. **Format** → **Bullets and Numbering**
3. Select **Numbering Type** Tab
4. The **Bullets and Numbering** dialog box appears where different styles of numbering are displayed
5. Click on the particular style
6. Click Ok button
7. The selected text is numbered.

The bullets and numbering dialog box with the numbering type tab is displayed in Figure 6.25.

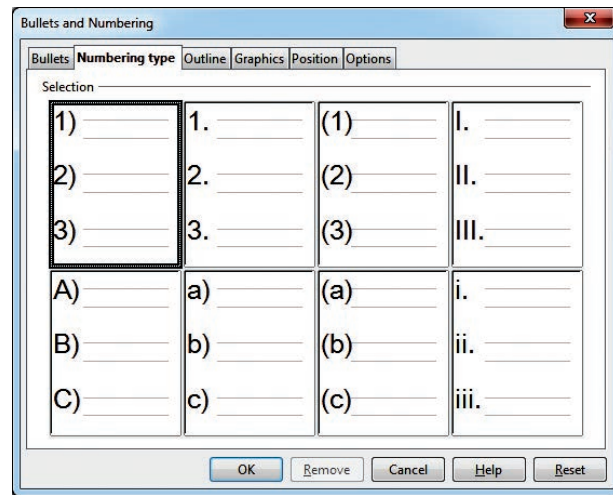

Figure 6.25 Bullet and Numbering dialog box



**DO YOU KNOW?** Bullets and numbered lists provide an excellent way to segregate, list and organize information to the reader. You can control the appearance or format, of a bulleted or numbered list.

#### Note

If the text is not typed, then apply the steps above and then type the text, the newly entered text will appear in numbered form.

### Turning off Bullets and Numbering

As you can quickly add bullets or numbers to existing text by clicking on the icons, the bullets and numbers can be removed easily.

- Select the text where the bullets and numbers are to be removed.
- Click on the Bullets icon  again to remove bullets.
- Click on the Numbering icon  again to remove numbering.

## 6.9 Page formatting

The most important thing in a word processor is how to format the page elements such as margins, numbering, page layout, headers and footers. Formatting your page makes it look more attractive and make it easier to read.

### 6.9.1 Setting the page size and margins

#### Changing page size

The default page size in Writer is 8.5 x 11”, the same as that of a standard A4 printing paper. However, for different types of documents, you may need to change the page size. To change the paper size:

- Select the page to be resized
- Select **Format** → **Page**, the page style dialog box appears as shown in Figure 6.26.
- Select **Page** Tab
- In the **paper format group**, select the format like A4, legal etc.
- Or the **width** and **height** option can be used to set the page size.

#### Changing page margins

Page margins are the white space

around the top, bottom, left, and right of your document. Margins let Writer know where to start placing the text at the top of a document, when to move on to the next page at the bottom, where to start typing text on the left side, and where to stop and move to the next line on the right.

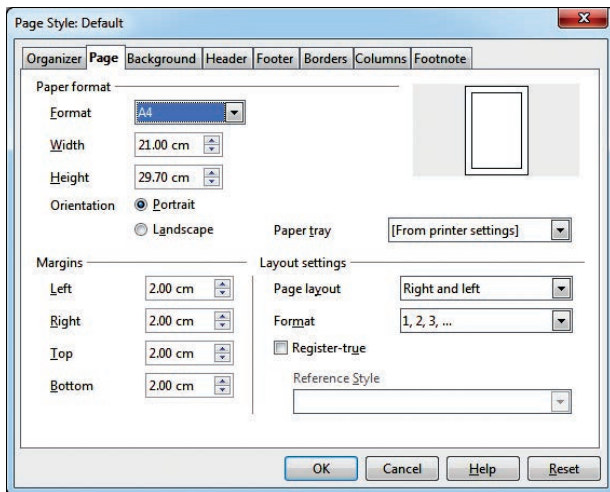

Figure 6.26 Page style dialog box

Changing or setting page margins in OpenOffice Writer can be done in two ways:

1. Using the **Rulers** - quick and easy, but does not have precise values.
2. Using the **Page Style dialog box** - can specify precise values for the margins.

#### 1. Changing page margins - using Ruler

1. The shaded sections of the rulers are the margins.
2. Hold the mouse pointer over the line between the gray and white sections.
3. The mouse pointer turns into a double-headed arrow.
4. Hold down the left mouse button and drag the mouse to move the margin and release it at the required point.
5. The new margin is set.

#### 2. Using the Page Style dialog box

To change margins using the Page Style

dialog box

1. **Right-click** anywhere on the page and select Page from the popup menu and select **page tab** of **Page Style dialog box** as shown in Figure 6.26.
2. In the **Margins** group, specify the values for left , right , top and bottom margins.
3. Click ok button.

### 6.9.2 Orientation

Page orientation refers to how the document will be displayed on screen and printed. There are two different orientations:

**Landscape** - The width of the document is more than the height. This is best suited for displaying professional photos, invitations, albums, tables etc.



**Portrait** - This is the most common and default orientation . Here, the height of the document is more than the width. Normally books, newspapers will be displayed in this format.

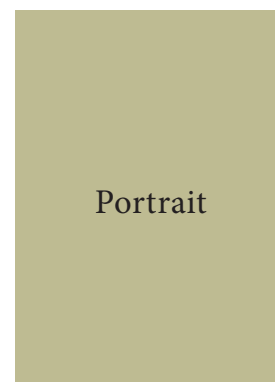

#### To change the orientation:

- Select the page whose orientation is to be changed

- In the **Page Style dialog box**, under the **Orientation** group,
- Select **Portrait** or **Landscape** button.
- Click **ok** button.

### 6.9.3 Page colour and borders

Changing the page color is not quite common. To do so, in the **Page Style dialog box**, select **Background** tab, In **As** option click on **color** and select the “color” from the color palette or select “**graphic**” to apply an image as a page background, as shown in Figure 6.27.

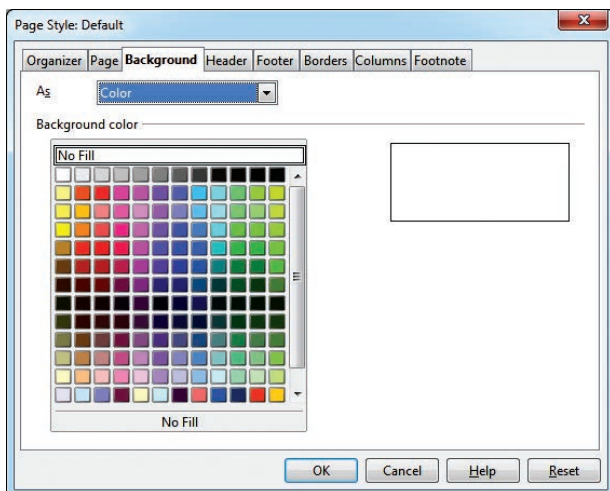

Figure 6.27 Background color

Borders can be applied to an entire document, an entire page, paragraph, or just to certain sections of the document. From the **Page Style dialog box**, select the **Borders** tab, the **User-defined** area helps to define the area of borders, the line style of borders, color of borders can be selected. The dialog box in Figure 6.28 shows the borders setting in the Page Style dialog box.

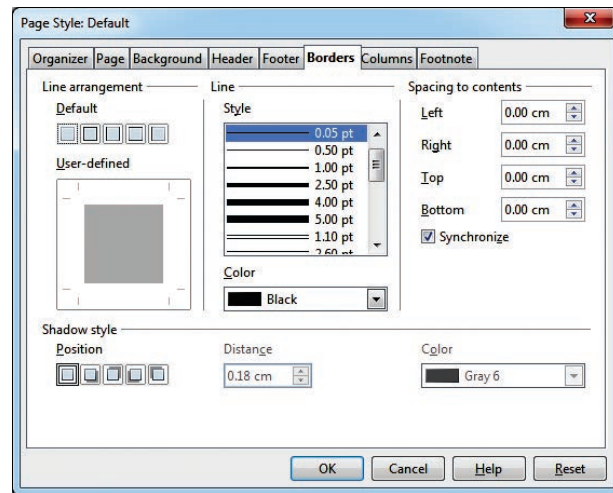

Figure 6.28 Page style dialog box - Borders

## 6.10 Working with Headers and Footers

The **Header** is a section of the document that appears in the **top margin**, which displays the title or chapter name, author name of a document.

The **Footer** is a section of the document that appears in the **bottom margin** of the page which displays the page number, date, time etc. which gets displayed on all the pages automatically.

### 6.10.1 Inserting Header and Footer

- Select from the main menu **Insert** → **Header** → **Default**
- The header text area is separated from the normal text area.
- In the header area, enter the text that is to be repeated in all pages or Select **Insert** → **Fields** → **Title**.

Similarly to insert a Footer, the steps are as given below:

- Select from the main menu **Insert** → **Footer** → **Default**

- Place the insertion pointer in the footer area of the page.
- Select **Insert** → **Fields** → **Date** to insert date in all the pages.

Once the Headers and Footers are given in the first page, the same text appears in all the pages.

### 6.10.2 Inserting and Formatting page numbers

Once the Header / Footer area are created, the page numbers can be inserted by performing the following steps:

- Place the insertion pointer where you want to insert the page number
- choose **Insert** → **Fields** → **Page Number**
- The page number appears with a gray background

Normally, the page numbers appear as 1,2,3....., To change the numbering style, the following sequence of steps can be performed:

- Position the insertion pointer where the page number has to appear
- Select **Format** → **page**, which will display the **Page Style** dialog box as in Figure 6.29.
- Select **Page Tab**
- In the Layout settings, select the Format drop down combo box
- Select the desired style and click **OK** button.

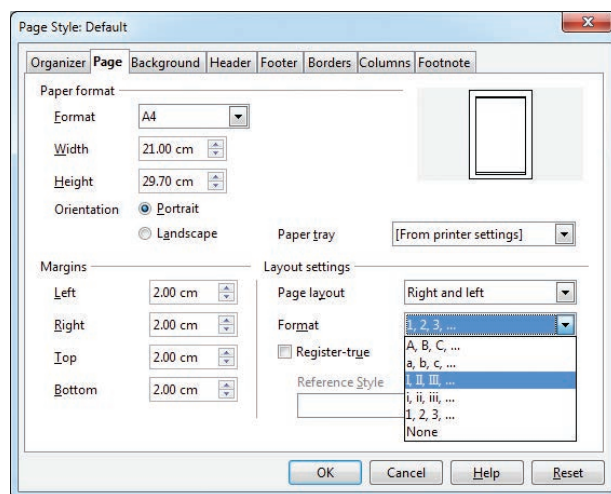

Figure 6.29 Page Style dialog box

## Workshop

### 6.4

1. Open a new document in OpenOffice writer.

- Type the following paragraph

“Learning gives creativity, creativity leads to thinking, thinking provides knowledge, and knowledge makes you great”

- Save the document
  - Perform text formatting features like Bold, Italics, Underline, Change font, change Size, Color and change case (Upper case to lower case, lower to upper) for the words. (in the paragraph and make the paragraph more appealing to read.
  - Highlight the text “ Knowledge makes you great”
  - Undo all formatting options using keyboard shortcut.
- 

### 6.5

- Open the document created in the workshop 6.1
- Type the following lines below the first paragraph

“ When one door closes, another opens, but we often look so long and so regretfully upon the closed door that we do not see the one that has opened for us – Alexander Grahambell ”

- Using any one of the paragraph alignment icons or keyboard shortcuts (left, right, center, or justified) align the first paragraph.
  - Change the line spacing of second paragraph to any one of the type.
  - Create bullets for the first paragraph and numbering for the second paragraph using icon or menu choice.
  - Save and close this documents.
- 

### 6.6

- Open the document created in workshop-6.2.
- Change page size, margin and orientation, change border and background color.
- Apply suitable header and footer for the table.

## Part - III : Find & Replace and Spell check

### 6.11 Find & Replace

OpenOffice Writer has a Find and Replace feature that helps to locate for a text inside a document and replace it with another word. In addition to finding and replacing words and phrases, you can also use wildcards and regular expressions to perform advanced search. To search a word

- Click **Edit** → **Find & Replace** (or) **Ctrl + F**
- The Find & Replace dialog box appears as shown in Figure 6.30

#### Steps to find & replace a text

1. Type the text you want to find in the **Search for** box

For Example : To search a word "Bombay" in a document and replace with "Mumbai", enter the word "Bombay" in the **Search for** box.

2. To replace the text with different text, type the new text in the **Replace with** box

Enter the word " Mumbai" in the **Replace with** box and Click **Find** button , to start the search , the found word is highlighted and the first occurrence of "Bombay" is highlighted.

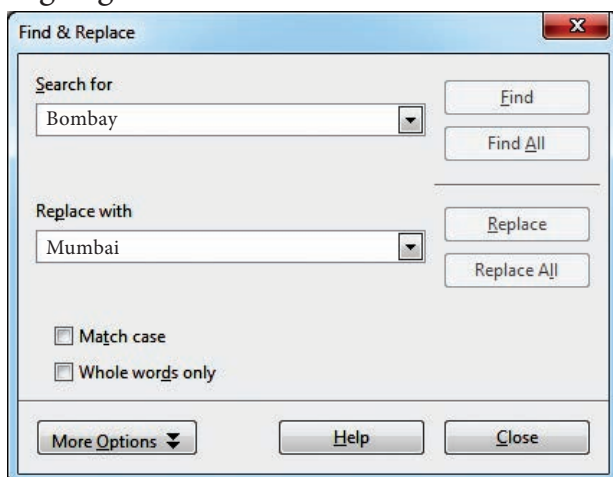

Figure 6.30 Find & Replace dialog box

3. To replace text, click **Replace** button.

The highlighted word is replaced with the word given in the **Replace with** box.

4. Click **Find All**, Writer selects all instances of the search text in the document.

All occurrences of Bombay are highlighted.

5. Click **Replace All** button, Writer replaces all matches.

This will replace all occurrences of "Bombay" with "Mumbai".

6. Enable **Match case** to perform the search case sensitively so that uppercase and lower cases are distinguished separately.

7. Enable **Whole Words only** to make the search more specific to words. For example, if you search for the word "Image", the command will only find "Image" not "Imaging", "Images" etc.

### 6.12 Spell Check

The documents prepared using word processing software should be without any spelling mistake. For this purpose OpenOffice Writer includes a dictionary and a spell check program. OpenOffice Writer can identify the spelling mistakes as the document is typed or after the entire document is typed.

#### 6.12.1 AutoSpellCheck

AutoSpellCheck option checks each word as it is typed and displays a wavy red line under any misspelled word. Once the word is corrected, the red wavy line disappears. This can be done by clicking the AutoSpellCheck icon 

- **Right-click** on a word with a wavy underline, to open a powerful context menu. Correct words can be selected

from the suggested words on the menu. The selection will replace the misspelled word with correct word.

To perform a separate spelling check on the document (or a text selection) click the Spelling and Grammar icon . This checks the document or selection and opens the Spelling dialog box (Figure 6.31) if any misspelled words are found. This can also be achieved by pressing F7 key

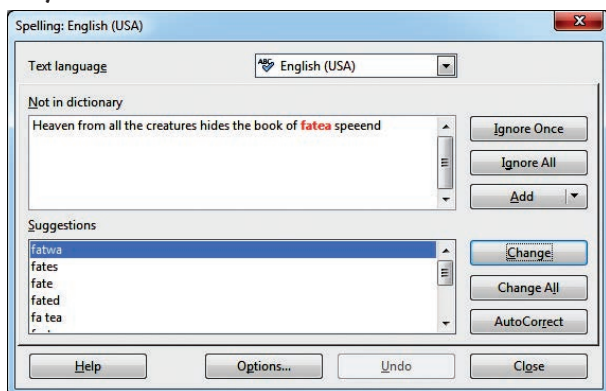

Fig: 6.31 The Spelling dialog box

Here are some more features of the spelling command:

- **Not in Dictionary** text area displays the misspelled word **Suggestions** box displays alternate spellings. **Ignore once** button is to skip the word once, **Ignore All** button skip occurrences of the word. **Change** button will change only that particular occurrence. **Change All** button will change all occurrences of the word.
- The text language can be changed (for example, Spanish, French, or German) from the Spelling dialog box.
- The new words can be added to a dictionary. Click **Add** in the Spelling dialog box and pick the dictionary to add it to.

## 6.12.2 Automatic correction

Auto Correct feature has the facility to correct the common misspellings and typing errors, automatically. For example, “hte” will be changed to “the”, which can be done through the menu option, **Tools** → **AutoCorrect** to open the AutoCorrect dialog box as shown in the Figure 6.32 which provides the chance to change the misspelled word with the correct word. To make an AutoCorrect entry

- Select **Tools** → **AutoCorrect**
- AutoCorrect dialog box appears
- Click **Replace** Tab
- In **replace** box, type the misspelt word
- In **with** box, the correct word
- Click **New**

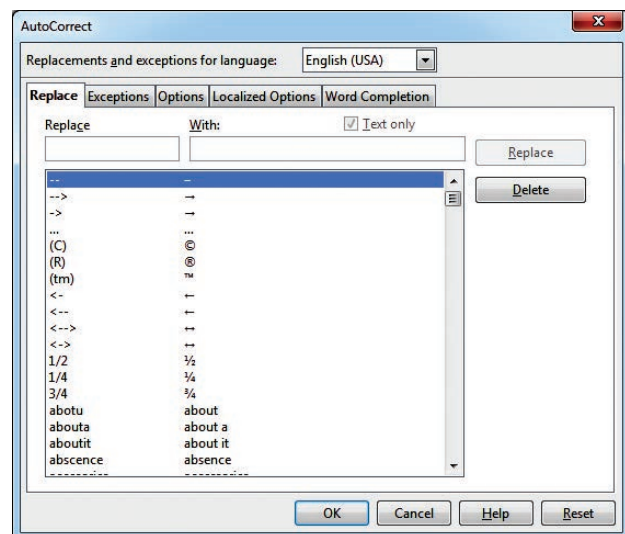



Figure 6.32 AutoCorrect wizard

 AutoCorrect is automatically turned on. To turn it off, uncheck **Format** → **Autocorrect** → **While Typing**.

AutoCorrect can be used as a quick way to insert special characters. For example, (c) will be autocorrected to ©. You can add your own special characters.

**Activity 1:**

Do the necessary steps to correct the word “comupter” into “computer” automatically

1. Goto **Tools** → **AutoCorrect Options**  
AutoCorrect dialog box appears as shown in Figure 6.34
2. Click the **Replace** tab and type “comupter” in **Replace** text box and “computer” in **with** textbox. then Click **New** and then **OK**
3. The word “Comupter” is replaced with “Computer” and displayed in the list.
4. After entering this, when you type “comupter” in the document, it will be automatically changed to the correct spelling “computer”.

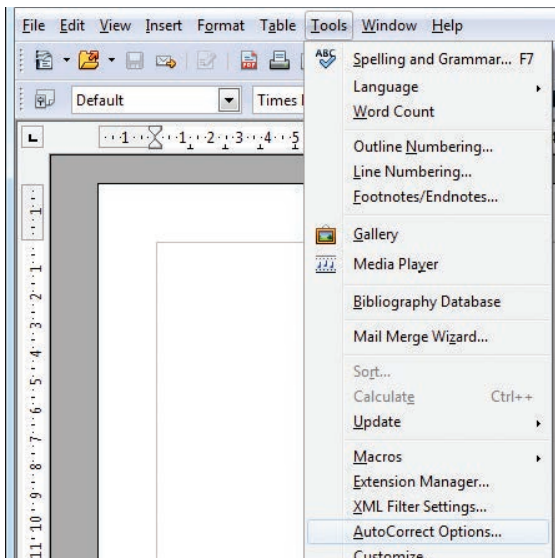

Figure 6.33 Auto correct menu

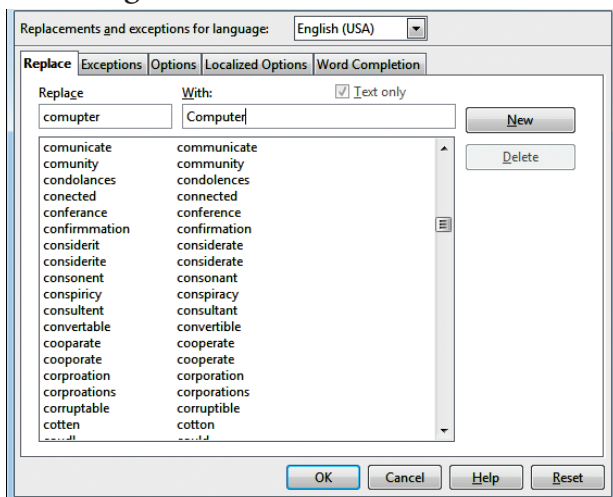

Figure 6.34 Autocorrect dialog box

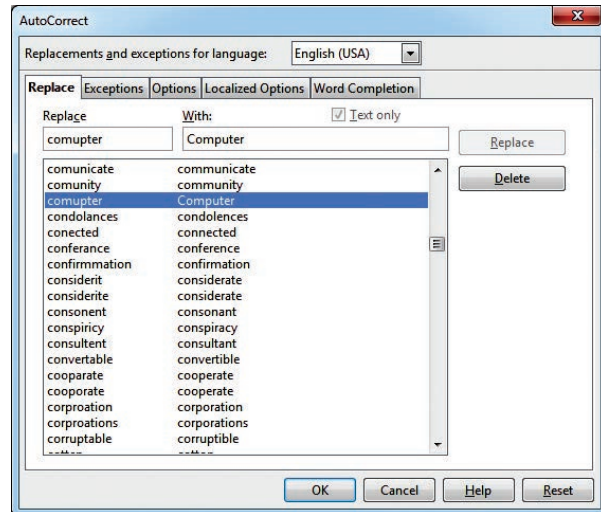

Figure 6.35 Auto correct list

### Workshop

- Open a new document and type the following paragraph
- “All birds find shelter during a rain. But Egles avoid rain by flying above the clouds. Problems are common, but attitude make the difference.”
- Apply spelling check and find the word “Egles” and replace it with “Eagles”.
- Save the document with password.



## Part - IV : Working with Tables

### 6.13 Inserting Tables

A table is a grid with a specified number of **rows** and **columns**. Tables can often be used as an alternative to spreadsheet to organize materials. A well-designed table can help readers to understand better what you are trying to convey.

#### 6.13.1 Different techniques to insert tables

To insert a new table, position the insertion pointer where you want the table to appear, then use any of the following methods to open the **Insert Table dialog box** as shown in Figure 6.36.

There are two methods to create a table :

##### Method 1. Table Icon

To insert a table quickly from the standard tool bar:

1. Place the insertion pointer where you want the table to appear.
2. Click the **down arrow** to the **right side** of the Table icon .
3. In the drop down grid, select the number of **rows** and **columns** for the table.
4. The table will appear at the location of the insertion pointer.

##### Method 2. Insert table dialog box

To insert a table with more control over the settings and properties, use the **Insert Table dialog box**.

To open the dialog box: Select **Table** → **Insert** → **Table** or **Ctrl + F12** or **left-click** the **Table** icon. From this dialog box, you can:

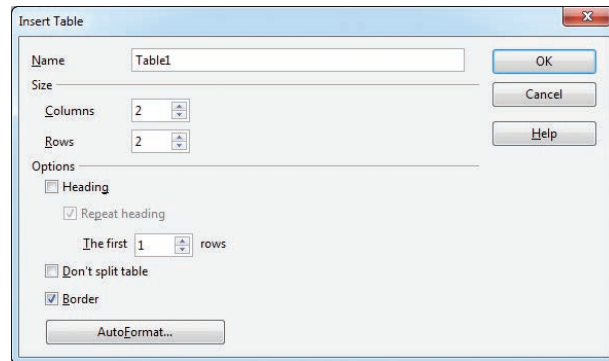

Figure 6.36 Insert Table Dialog Box

- Select the number of **rows** and **columns** of the table
- Give a **Name** to the table in the **Name** Text box
- Select the **Heading** check box to define the first row in the table as the heading
- Select the **Repeat heading** check box to repeat the heading row if the table spans more than one page
- Select the **Don't split table** check box to prevent the table from spanning more than one page
- Select the **Border** check box to display table with grid.
- Click ok

The **AutoFormat** button at the bottom of the Insert table dialog box opens the AutoFormat dialog box as shown in Figure 6.37.

From here, it is possible to choose among different predefined formats.

If none of the predefined auto formats have the desired characteristics for your table, you can tune the format of the table or a particular cell with the contextual Table toolbar. Open the toolbar by placing the insertion pointer inside a table cell or

select **View** → **Toolbars** → **Table**. This will bring the **table formatting** toolbar which helps to format the table in the desired format.

### 6.14 Formatting table

Formatting a table involves formatting of the **table layout**, formatting the **table text**, adjusting the **size of the table**, its **position** on the page, **adding or removing rows or columns**, **merging and splitting cells**, **changing borders** and the **background**.

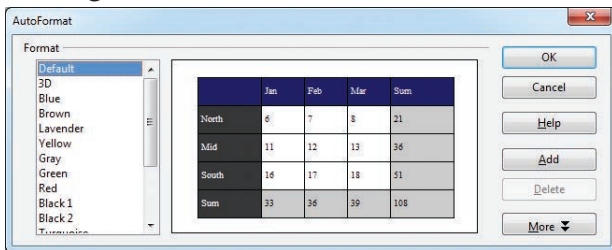

Figure 6.37 Auto format Dialog Box

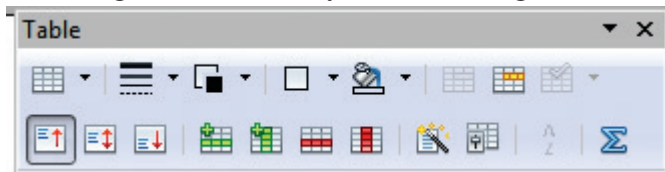

Figure 6.38 Table Formatting Toolbar

#### 6.14.1 Inserting rows and columns

To insert rows or columns inside a table:

1. Place the insertion pointer in the row or in the column where you would like to add new rows or columns and **right-click**.
2. Choose **Row** → **Insert** – to insert a new row or **Column** → **Insert** – to insert a new column. A dialog box will appear, from which you can select the number of rows or columns to insert. You can also set the position of the new rows or columns to **Before** or **After** as shown in Figure - 6.39.

3. Click OK to close the dialog box.

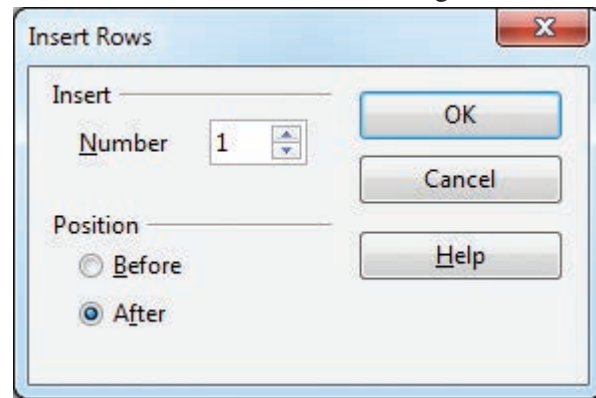

Figure 6.39 Insert Row Dialog Box

#### 6.14.2 Deleting rows and columns

To delete rows or columns inside a table:

1. Place the insertion pointer in the row or column to be deleted and **right-click**.
2. Choose **Row** → **Delete** to delete a row or **Column** → **Delete** to delete a column.
3. The selected row / column is deleted.

#### 6.14.3 Merging and Splitting cells

To merge a group of cells:

1. Select the cells to merge.
2. **Right click** and choose **Cell** → **Merge** or choose **Table** → **Merge Cells** from the menu bar.

To split a cell:

1. Place the insertion pointer inside the cell.
2. **Right click** and choose **Cell** → **Split**, or choose **Table** → **Split Cells** from the menu bar.
3. Select the direction of the split, horizontally (for rows), or vertically (for columns), as well as the total number of cells to create.

## Workshop

### 6.7

- Open a new document.
  - Using icon or table menu create the given table with required of 5 rows and 6 columns with the labels S.No., Name, Maths, Phy, Che and Total
  - After the sixth row add a new row and type suitable data for the new row.
  - Delete the second row using icon or command.
  - Using icon or command after the second column add a new column and type suitable data for the new column.
  - Delete any one column using icon or command.
  - Save and close the document.
- 

### 6.8

- Open the document created in workshop-6.7.
  - Do the following options :
    - Change the border style and border line width for one table.
    - Change height and width for the row and column respectively.
    - Save and close the document.
  - Create a new document.
  - Create a 4 x 4 table using icons in toolbars or using commands.
  - Split any one row/ column in one given table into more than one cell using icon or command.
  - Merge any two or more row / column in the given table using icon or command.
- 

### 6.9

- Open the document created in workshop-6.8.
- Delete the table contents.
- Perform all table formatting options for this table.
- Add two more rows and columns and also delete the rows and columns.
- Save and close the document.

## Part - V : Enhancing and Printing a document

### 6.15 Enhancing a Document

#### 6.15.1 Inserting pictures

OpenOffice Writer has the ability to insert and edit images in a more simple way. The picture gallery of the Writer consists of a collection of images from which the desired image can be selected and inserted into the document. To insert an image from a file, the steps are as follows:

- Place the insertion pointer where you want the image to appear
- Select **Insert** → **Picture** → **From file**
- The **insert picture dialog box** appears where the picture gallery opens from which the desired picture can be selected.
- If the picture is not in the gallery, then browse the pictures from the folder, choose the desired picture.
- Click on the **Open** button
- The selected picture is inserted into the document

#### 6.15.2 Inserting Special Characters

Many symbols which are used in a mathematical equation like alpha( $\infty$ ), beta( $\beta$ ), pi( $\pi$ ) etc., are not available on the standard keyboard. However, representing these characters are very much essential

in mathematical equations. To insert such characters, the procedure given below is followed:

- Place the insertion pointer in your document where you want the character to appear
- Click on **Insert** → **Special Characters**
- The **Special Characters dialog box** appears as shown in Figure 6.41 from which the desired symbol can be selected by clicking on the character.
- As you select each character, it is shown on the lower right, along with the numerical code for that character
- If you do not find a particular special character you want, try changing the font selection.
- Click the **OK** button and the character is inserted at the current location.

The insert special characters dialog box is displayed in Figure 6.40.

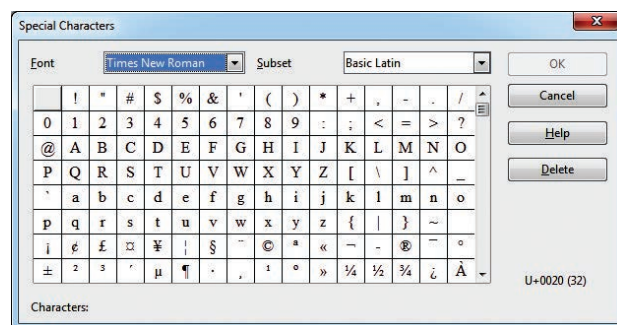

Figure 6.40 Insert Symbol Dialog box

#### 6.15.3 Inserting Shapes

OpenOffice Writer uses the drawing tools, to create various shapes by using

the Drawing toolbar. To use the drawing tools repeatedly, you can move this toolbar to a convenient place on the window. The drawing tool bar can be obtained by clicking **View** → **Toolbars** → **Drawing** as displayed on Figure 6.41.



Figure 6.41 Drawing toolbar

To use a drawing tool, the steps are as given below:

- Click in the document where you want the drawing to be displayed.
- Select the **tool** from the **Drawing toolbar** as shown in Figure 6.44 The mouse pointer changes to a **cross-hair pointer**.
- Move the **cross-hair pointer** to the place in the document where you want the drawing to appear and then click-and-drag to create the drawing object.
- Release the mouse button. The selected drawing function remains active, so you can draw another object of the same type.
- To cancel the selected drawing function, press the **Esc** key or click on the **Select icon** on the **Drawing toolbar**.
- You can now change the properties (fill color, line type and width, change Anchor, and others) of the drawing object using either the **Drawing Object Properties** toolbar or the choices in the dialog box.

#### 6.15.4 Inserting AutoText

AutoText allows you to assign text, tables, graphics and other items to a key or key combination. For example, rather than typing "TamilNadu" every time you use that phrase, you might just type "tn" and

press **F3**. You can also save a formatted Tip as AutoText and then insert a copy by typing "tip" and pressing **F3**.

To assign AutoText shortcut to some text, the steps are as follows :

1. Type the text into your document.
2. Select the text so that it is highlighted.
3. Select **Edit** → **AutoText** (or press **Ctrl+F3**).
4. Enter a name for your shortcut. Writer will suggest a one-letter shortcut, which you can change.
5. Click on the inverted arrow of the **AutoText** button on the right and select **New (text only)** from the menu.
6. Click **Close** to return to your document.
7. Once the entry is created, to insert the auto text into the document, place the cursor where the text is to be inserted and click **Ctrl+F3**,
8. Select the name from the list of entries and click **Insert** button.
9. The auto text is inserted into your text.

#### Note

If the only option under the AutoText button is Import, either you have not entered a name for your AutoText or there is no text selected in the document.

## 6.16 Page Preview , Setting the printer and Printing a document

### 6.16.1 Preview the document to be printed

It is a good practice to preview the document before taking the print out. The steps to be followed to preview the document :

1. Click **File** → **Page Preview**, or click the **Page Preview** icon. The Writer displays the Page Preview toolbar
2. In the page preview tool bar click **Multiple Pages icon** to display multiple pages.
3. To close the preview click the **Close Preview button**.

### 6.16.2 Setting the Printer and Printing

The following are the steps to change the printer setting :

1. Click **File** → **Print or Ctrl + P or Print File Icon** which opens the Print dialog box as shown in Figure 6.42.

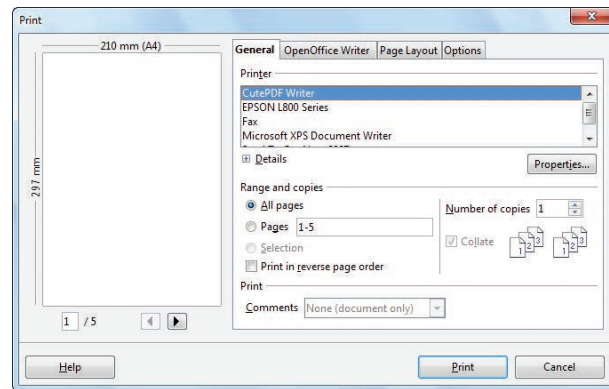

Figure 6.42 Print Dialog box

2. Click **General** Tab.
3. Select the required printer from the list of printers.
4. Under **Range and copies** section : select **All Pages** option to print all pages, select **Pages** option to specify the particular page or page range.
5. Specify **Number of Copies** using spin arrows.
6. Click **Print** button.

## Activity



### Student Activity

1. Make the students prepare a invitation for school annual day.
2. Let the students prepare their class timetable in table format and format it in an attractive manner.
3. Make the students create a greeting card in landscape format with a picture and a birthday message and distribute to students on their birthday.

### Teacher Activity

1. To show a demo to the students how to type a question paper by using formulas and special characters, changing the margins and printing in the practical session.
2. To show the students a demo of inserting a picture and applying crop , color changes, background and others features to modify it and make more attractive.

## Workshop

### 6.10

- Open the document created in Part-1 workshop-6.1
- Download images related to Dr. A.P.J ABDUL KALAM From net and insert the images in the document at required place using command or icon.
- Open the document in Part-III – workshop-1 , download images related to the content from net and insert the images at required place.
- Save the document and close.

### 6.11

- Open a new document.
- Using the commands to insert special characters, special symbols
- Type the following equations (i)  $A\alpha + Br + c\beta$  (ii)  $\pi r^2 h$ .
- Using drawing toolbar insert various drawings/ shapes in your document
- Save and close the document.

### 6.12

- Open the document created in workshop-6.2
- Using Autotext command or keyboard shortcut create shortcut for
- “Vital Information Under Seize” as “VIRUS” and make it appear in one document.
- Using Print icon change printing attributes, preview and print the document.

### 6.13

- Open the document created in workshop-6.4
- Insert suitable picture of a circle.
- Type the formula for the circumference of a circle using insert special character option.
- Using drawing tools draw the following in the document.
- Print the document using print command.



**Annexure 1**

Shortcut Key	Function
Ctrl+A	Select the whole document.
Ctrl+B	Makes text bold.
Ctrl+C	Copy the text.
Ctrl+D	Double Underline text.
Ctrl+E	Text is center aligned.
Ctrl+F	Find and Replace.
Ctrl+I	Makes text Italics.
Ctrl+J	Text is Justified.
Ctrl+L	Text is left aligned.
Ctrl+R	Text is right aligned.
Ctrl+U	Underlines text.
Ctrl+V	Paste the text.
Ctrl+X	Move the text.
Ctrl+Y	Redo last action.
Ctrl+Z	Undo last action.
Left Arrow	Move cursor one character left.
Right Arrow	Move cursor one character right.
UpArrow	Move cursor one line up.
DownArrow	Move cursor one line down.
Shift+ LeftArrow	Move cursor with selection to the left.
Shift+ RightArrow	Move cursor with selection to the right.
Ctrl+ LeftArrow	Go to beginning of word.
Ctrl+ RightArrow	Go to end of word.
Home	Go to beginning of line.
End	Go to end of line.
Ctrl+Home	Go to start of document.
Ctrl+End	Go to end of document.
Shift+Home	Go and select from the beginning of line.
Shift+End	Go and select till end of line.
Insert	Insert mode on/off.
Page Up	Move one screen up.
Page Down	Move one screen down.
Ctrl+Shift+B	Subscript.
Ctrl+Shift+P	Superscript.



## Annexure 2

## Unicode Tamil Keyboard Typing Chart

a	அ	k	க்	ka	க	ke	கே
aa	ஆ	ng	ங்	nga	ங	kee	கே
i	இ	s	ச்	sa	ச	ko	கொ
ii	ஈ	nj	ஞ்	nja	ஞ	koo	கோ
u	உ	d / t	ட்	da / ta	ட	kau	கௌ
uu	ஊ	N	ண்	Na	ண		
e	எ	w	ந்	wa	ந	we	நெ
ee	ஏ	th	த்	tha	த	wee	நே
ai	ஐ	p	ப்	pa	ப	wo	நொ
o	ஓ	m	ம்	ma	ம	woo	நோ
oo	ஔ	y	ய்	ya	ய	wau	நௌ
au	ஔ	r	ர்	ra	ர		
q	ஓ	l	ல்	la	ல		
		v	வ்	va	வ		
		z	ழ்	za	ழ		
		L	ள்	La	ள		
		R	ற்	Ra	ற		
		n	ன்	na	ன		

j	ja	jaa	je	jee	jo	joo	ji	jii	ju	juu
ஜ்	ஜ	ஜா	ஜெ	ஜே	ஜொ	ஜோ	ஜி	ஜீ	ஜு	ஜு
sh	sha	shaa	she	shee	sho	shoo	shi	shii	shu	shuu
ஷ்	ஷ	ஷா	ஷெ	ஷே	ஷொ	ஷோ	ஷி	ஷீ	ஷு	ஷு

WorkShop -6.14 : Type the following content in Tamil using any interface (Murasu / NHM / Azhagi).

kaNNan - கண்ணன்	joothpur - ஜோத்பூர்
sennai - சென்னை	juulai - ஜுலை
thamiznaadu - தமிழ்நாடு	shiradi - ஷீரடி
thaajmahaal - தாஜ்மஹால்	hamadu - ஹமது
shaajakaan - ஷாஜகான்	vaashingtan - வாஷிங்டன்

சென்னையில் உள்ள மாநகராட்சிப் பள்ளிகள் சென்னைப்பள்ளிகள் (Chennai Schools) என்று அழைக்கப்படுகிறது. இந்த பள்ளிகளை நிர்வகிக்க சென்னை மாநகராட்சியில் கல்வித்துறை (Education Department) இயங்கி வருகின்றது. ஒரு இந்திய ஆட்சிப்பணி (IAS) அதிகாரி, ஒரு கல்வி அலுவலர் (Educational Officer) மற்றும் 10 துணைகல்வி அலுவலர்களுடன் (Assistant Educational Officers - AEO) இத்துறை செயல்படுகிறது.

## Evaluation



### Part – I

#### Choose the correct answer

1. Which is the opening screen of OpenOffice?
  - a. Star desktop
  - b. Star center
  - c. Star screen
  - d. Star window
2. Which option allows you to assign text, tables, graphics and other items to a key or key combination?
  - a. Autoformat
  - b. Automatic
  - c. Auto text
  - d. Autographics
3. Which menu contains the Numbering option?
  - a. File
  - b. Edit
  - c. Tools
  - d. Format
4. Which is displayed at the top part of the window?
  - a. Menu bar
  - b. Tool bar
  - c. Title bar
  - d. Format bar
5. What is changing the default appearance of the text called?
  - a. Text formatting
  - b. Page formatting
  - c. Special formatting
  - d. Paragraph formatting
6. Find & Replace option is available in which menu?
  - a. File
  - b. Edit
  - c. Format
  - d. Tools
7. Which button selects all instances of the search text in the document?
  - a. Find
  - b. Find All
  - c. Replace
  - d. Replace All
8. What is the shortcut key to go to the start of the document?
  - a. Ctrl + Home
  - b. Ctrl + End
  - c. Home
  - d. End
9. What is the shortcut key for finding and replacing text in a document?
  - a. Ctrl + F1
  - b. Ctrl + F4
  - c. Ctrl + F5
  - d. Ctrl + F7
10. What is the short cut key for Undo?
  - a. Ctrl +E
  - b. Ctrl + U
  - c. Ctrl + Z
  - d. Ctrl + n

### Part – II

#### Very Short Answers

1. How do you insert pictures in to your document?
2. What are the different packages in OpenOffice Writer?
3. What is auto text in Writer?
4. How do you merge cells in a table?
5. State the differences between proprietary software and open source software.

### Part-III

#### Short Answers

1. What is the difference between moving and copying text?
2. What are the different types of orientation?

3. How do you insert rows and columns?
4. What are the different ways to save a document?
5. Write the steps to change the line spacing of text.

#### Part-IV

#### Explain in Detail

1. What are the different methods to change margin in Writer?
2. What is Header and Footer? How do you insert page numbers in footer area?
3. Write the steps to Find and Replace a word with another word in OpenOffice Writer?
4. Explain Page formatting in Writer.



WORD	MEANING
Word processor	A software used to create, edit, view, manipulate, transmit, store, print and retrieve a text document.
OpenOffice writer	A word processor component of OpenOffice.
Proprietary	Owner or ownership.
Embedding	To surround tightly or firmly.
Highlighting	Highlighting is used to draw attention to important information in a text.
Indents	Indents is the distance from the margin that is used to improve the efficiency and readability of the paragraph.
DDE	Dynamic Data Exchange – a mechanism where source data can be pasted into a destination with a link of the original.
Paste Special	The PasteSpecial option is used when only some aspects of the data, like only its formatting or only value is send while moving or copying.
Headers	This is the section at the top of the page where any references like title, chapter name, author name can be given which gets repeated on all pages.
Footers	This is the section at the bottom of the page where any references like page number can be given which gets repeated on all pages.
AutoText	This helps to assign shortcuts to some text which are frequently used.
Auto spell check	This feature automatically checks the spelling while typing and underlines the misspelt words with wavy lines which can be corrected later.
Automatic Correction	This feature automatically corrects the common misspellings and typing errors automatically.

## Part – I Working with OpenOffice Calc

## 7.1 Introduction to spreadsheet

Spreadsheet is a very useful office automation tool to organise, analyse and store data in a tabular form. Spreadsheet was developed as computerized equivalent to paper-based accounting worksheets.

Spreadsheet users can adjust any of the stored values and can observe the effects on the calculated values. This is called "What if" analysis. Modern spreadsheet can have multiple interacting sheets and can display data either as text or numerals or in a graphical form.

## 7.1.1 Evolution of Spreadsheet

Daniel Bricklin and Bob Frankston developed the first spreadsheet called "VisiCalc" in 1979 for Apple II. In 1982, Lotus Corporation introduced "Lotus 1-2-3"; Lotus 1-2-3 was the first to introduce cell names and macros. In 1987, Microsoft Corporation introduced Excel. Excel implemented a Graphical User Interface (GUI) and the ability to point and click using a mouse. There are lots of other spreadsheet applications; Microsoft Excel continues to be the most popular spreadsheet software.



### Daniel Singer "Dan" Bricklin The Father of Spreadsheet



Daniel Singer "Dan" Bricklin (born 16 July 1951), often referred to as "The Father of the Spreadsheet", is the American co-creator, with Bob Frankston, of the VisiCalc spreadsheet. He also founded Software Garden, Inc., of which he is currently President of Trellix Corporation, which is currently owned by Web.com. He currently serves as the Chief Technology Officer of Alpha Software.

OpenOffice Calc is a popular open source spreadsheet application maintained by Apache Foundation. StarOffice calc was the parent application of OpenOffice Calc which was developed by a German Company namely, Star Division in 1985.

## 7.2 Working with OpenOffice Calc

Calc is the spreadsheet component of OpenOffice. You can enter any kind of data in a spreadsheet and then manipulate this data to produce certain results. Alternatively, you can enter data and then use Calc in a 'What If...' manner by changing some of the data and observing the results without having to retype the entire spreadsheet.

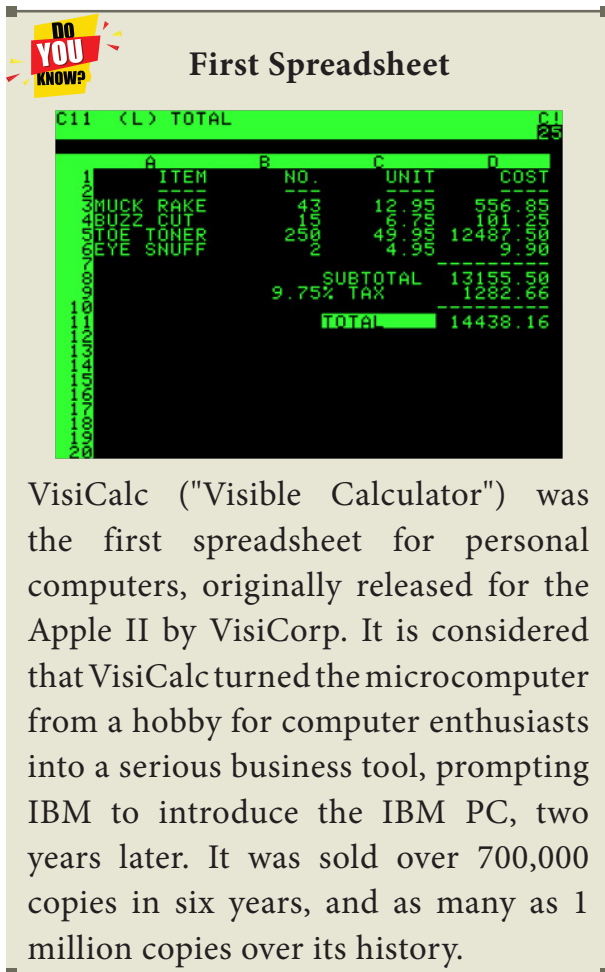

#### 7.2.1 Features of OpenOffice Calc:

- **Connecting with Excel** - Ability to open, edit, and save Microsoft Excel spreadsheets
  - **AutoSum** - helps you to add the contents of a cluster of adjacent cells.
  - **List AutoFill** - automatically extends cell formatting when a new item is added to the end of a list.
  - **AutoFill** - allows you to quickly fill cells with repetitive or sequential data such as chronological dates or numbers, and repeated text. AutoFill can also be used to copy functions. You can also alter text and numbers with this feature.
  - **Charts** - helps you in presenting a graphical representation of your data in the form of Pie, Bar, Line charts and more.
- **Functions:** which can be used to create formula to perform complex calculations on data
  - **Database functions:** to arrange, store, and filter data

#### 7.3 Creating a new worksheet

A new spreadsheet can be created through various methods. From windows, select

**Start** → **All Programs** → **OpenOffice** → **OpenOffice Calc** (or)

**From Star Center (Welcome Screen):**

Double-click on "**OpenOffice**" icon the desktop

Now, a welcome screen appears as shown in Figure 7.1.

This open screen is called as "**Star Center**". Calc is one of the component of OpenOffice. So, it may be invoked from the "**Star Center**" by simply clicking on the "**Spreadsheet**" icon. (or)

A new spreadsheet can also be created by selecting **File** → **New** → **Spreadsheet** from any OpenOffice Application. After using any one of the above said methods, OpenOffice Calc window appears as shown in Figure 7.2. The outline of the window is very similar to other application windows of OpenOffice. The main area of the Calc window is called as "Work area" or "Worksheet".

A worksheet is a grid of cells with a programmable calculator attached to each cell. When you open a new spreadsheet, there are three worksheets available by default. You can include more sheets and organize them.



Figure 7.1 Opening Screen (Star Center) of OpenOffice

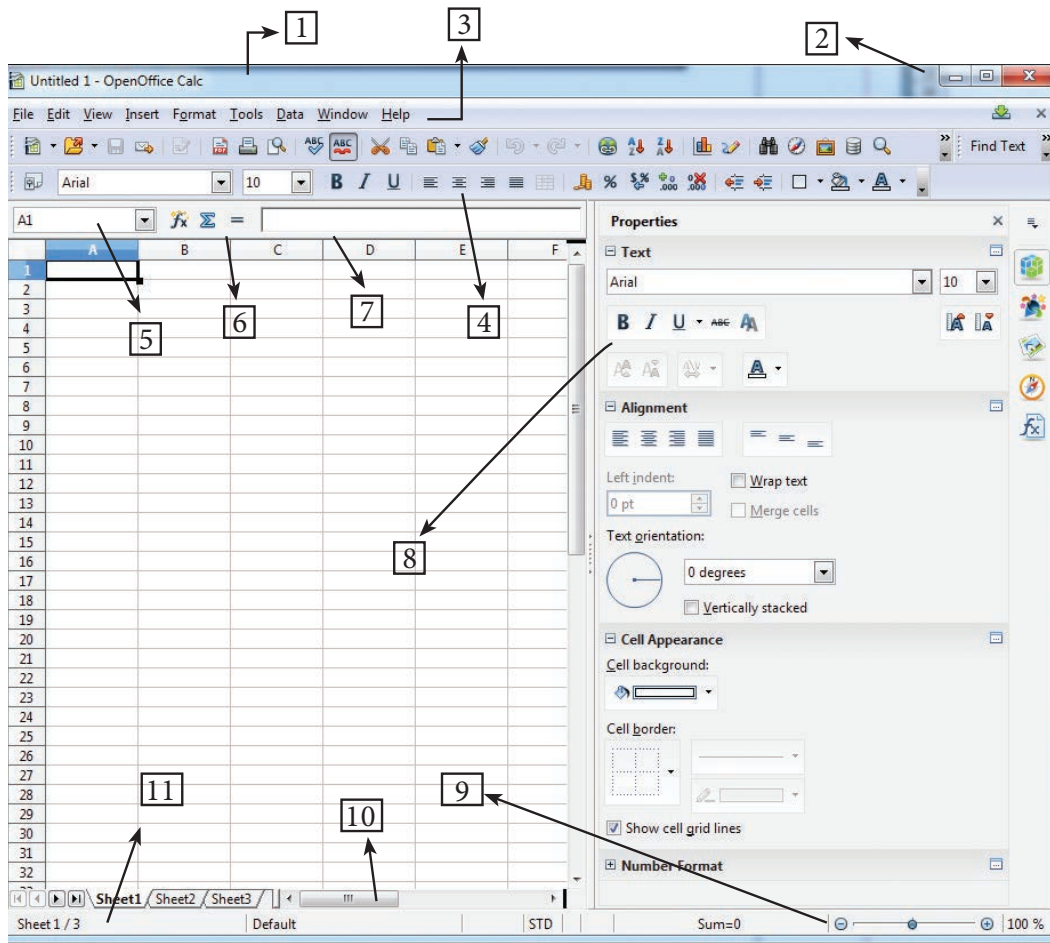

Fig 7.2 OpenOffice Calc Window

1. Title Bar	2. Control Buttons
3. Menu Bar	4. Tools Bar
5. Name Box / Address Box	6. Quick Function Wizard
7. Formula Bar / Input Line	8. Formatting Properties
9. Zoom	10. Scroll bar
	11. Status Bar

### 7.3.1 Parts of the OpenOffice Calc Window

Appearance of the Calc window is very similar to that of the Writer window. The workspace of writer is a big blank area. But, in calc, the grid of cells is the workspace.

#### 7.3.1.1 Title Bar

Top of the window is called the "Title Bar". It is used to show the name of the file and name of the application. In OpenOffice calc, the default name for the first unsaved worksheet is "Untitled1". When you save the file, Untitled will change to the name in which you saved.

#### 7.3.1.2 Control Buttons:

In the right corner of title bar, (1) minimize, (2) maximize / restore and (3) close control buttons are available.

#### 7.3.1.3 Menu Bar

Below the title bar is menu bar. Most of the menus are very similar to what you learnt in OpenOffice Writer.

**File** - menu contains the commands of all file management tasks like, Create a new file, Open an existing file, Close

the current file, Save a file, Save a file in another name, print file, Export file etc.

**Edit** - menu contains the editing commands like, cut, copy, paste, Undo, Redo, Fill etc., Most of the menu items are similar to Writer Edit menu. But, for Calc, some special editing options are available under this menu.

**View** - menu contains the commands which are used to modify the environment of calc.

**Insert** - menu contains commands for inserting various calc elements such as cells, columns, rows, functions, charts etc.,

**Format** - menu contains the commands of various text and cell formatting features.

**Tools** - menu contains various tools and functions such as spell check, protect document, insert pictures, macros, etc.,

**Data** - menu contains the commands to manipulate data in a spreadsheet such as sort, filter, subtotal, validity etc.,

**Window** - menu shows display options such as New Window, Close Windows, Split and Freeze.

**Help** - menu lists in-built help features available with OpenOffice.

#### 7.3.1.4 Tools Bar

Under the menu bar, there are three toolbars available by default. They are:

(1) Standard Toolbar      (2) Formatting Toolbar      (3) Formula bar

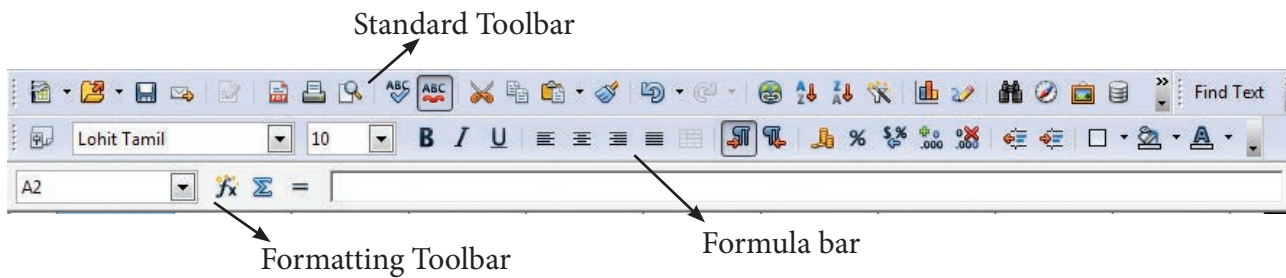

Fig. 7.3 OpenOffice Calc Toolbar

**Standard Toolbar** – contains frequently used File, Edit and Data menu commands as icons such as New Open Save, Send, print, print preview, Cut, Copy, Paste, Sorting, inserting chart etc.,

**Formatting Toolbar** – contains frequently used text and cell formatting commands as such as changing font style, font size, font colour, alignments, cell formatting etc.,

**Formula bar** – This is a very important element in a spreadsheet. It contains Name box, Function Wizard, Sum button, Function button and Input line (Refer Figure 7.4).

**Name box :** It display the current cell address

**Function Wizard :** It is used to insert function

**Sum button :** It is used to quickly insert sum function.

**Input Line :** This is used to show the contents of the current cell. It always shows actually what you typed in a cell. It is also used to edit the contents.

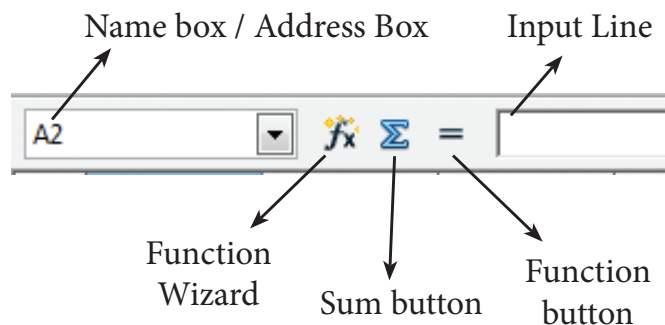

Fig. 7.4 Calc Formula bar

### 7.3.1.5 Scroll bar

Spreadsheet window also has two sets of scrolling bars (1) Vertical Scrollbar and (2) Horizontal Scrollbar (Refer Figure 7.5)

**Vertical Scroll bar :** It is used to move the screen up and down.

**Horizontal Scroll bar :** It is used move the screen left and right.

**Scroll buttons :** used to move the screen to the relative distance.



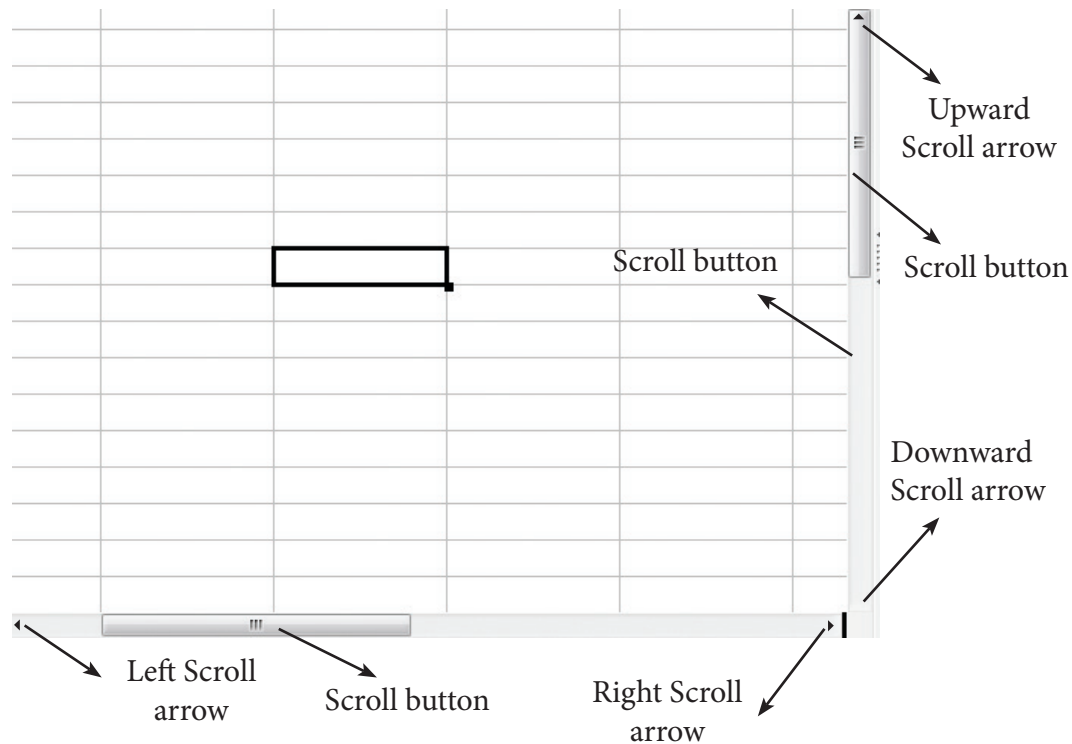

Fig. 7.5 Calc Scrolling bar

### 7.3.1.6 Row, Column, Cell and Cell Pointer

Below the formula bar contains the worksheet of work area which consist of grid cells. The worksheet has number of rows and columns, where each column is labelled as A, B, C, D ..... AA, AB, AC ..... and the rows are numbered from 1, 2, 3 .... (Figure 7.6).

OpenOffice Calc version 4.1.5 contains 1024 columns and 10,48,576 rows. Column heading starts from A and end with AMJ. In the case of Microsoft Excel 2016, there are 16,384 columns (A to XFD) and 10,48,576 rows available.

#### Cell

Intersection of each row and column makes a box which is called as "Cell". Each cell has its unique address.

Cell address is the combination of column heading and row number. For example, the intersection of column B and row 4 makes a cell B4. (Figure 7.7). Every cell is thus identified by its unique cell address.

Cell pointer is a rectangle box which can be moved around the worksheet. The cell in which the cell pointer is currently located is known as "Active cell". When you type any content, it will appear in the active cell. The address of the active cell is displayed in the Name box / Address box. Active cell's column name and row number will be highlighted. Using this visual clue, one can easily identify an active cell. Moreover, the contents of an active cell will be displayed in the formula bar.

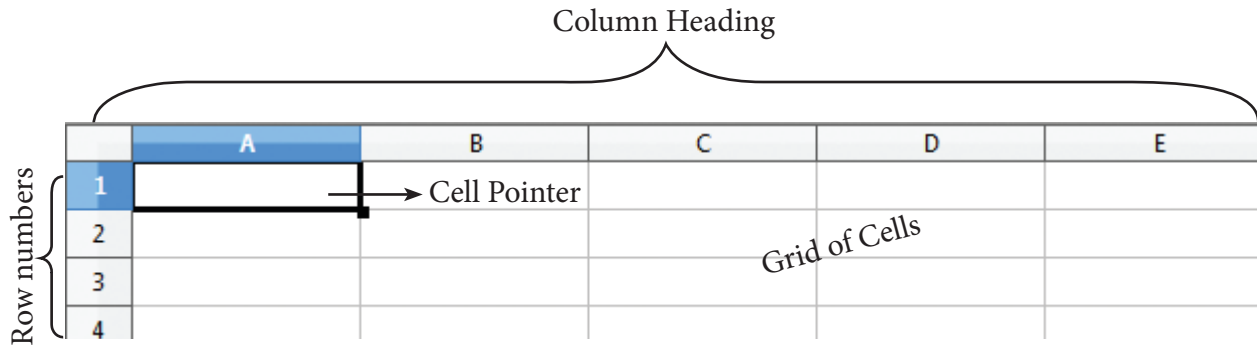

Fig. 7.6 Calc Rows, Columns, Cells

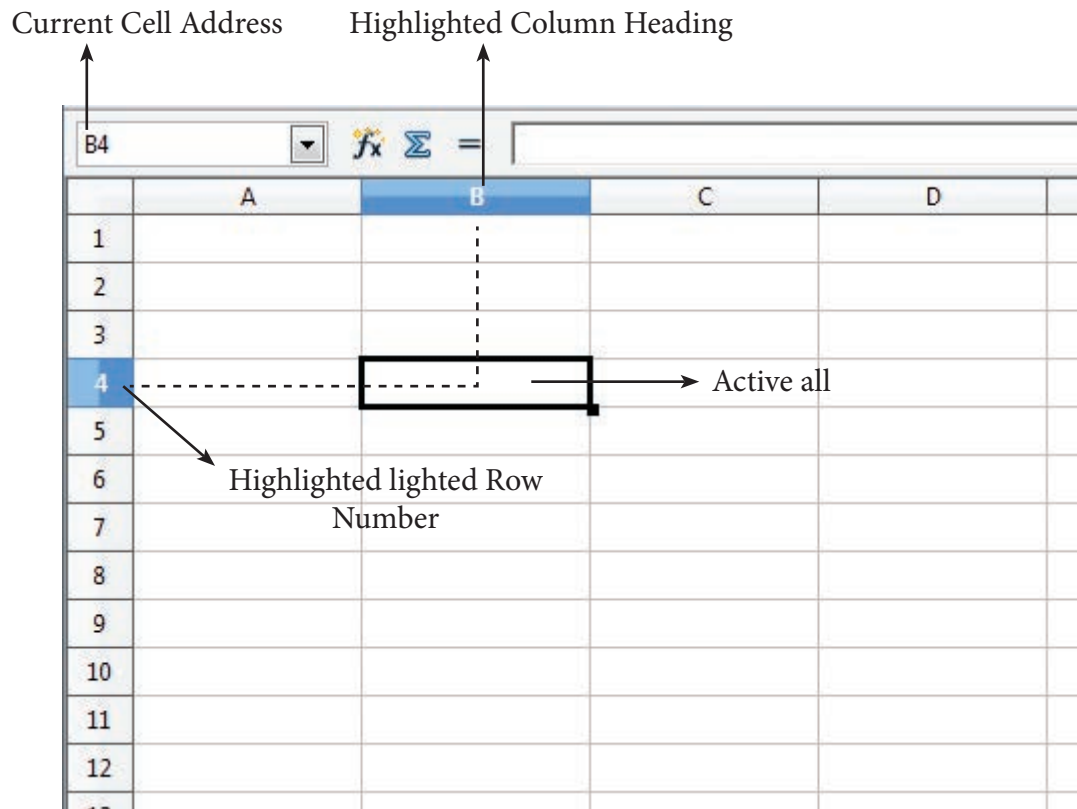

Fig. 7.7 Cells, Rows and Columns

7.3.1.7 Worksheet tabs:

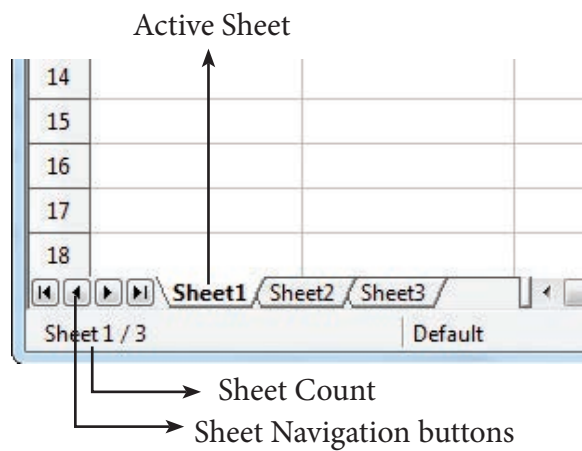
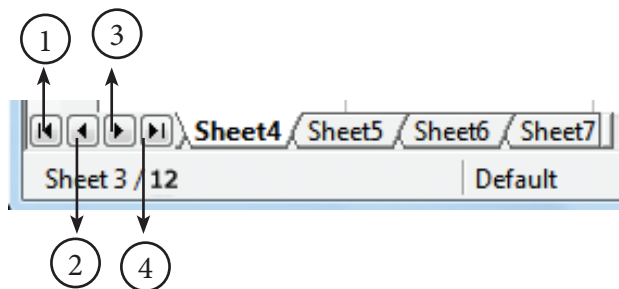

Fig. 7.8 Calc Sheet Tab

At the bottom of the grid of cells are the sheet tabs. By default there are 3 sheets “Sheet1”, “Sheet2” and “Sheet3”, (Figure 7.8). When you open a new worksheet, sheet1 is the default active sheet. Active sheet tab will appear in white colour. If you click on another sheet, it will become active and its colour will turn white. Multiple sheets can also be selected by clicking the sheet and press the Ctrl button (Ctrl + Click). Selected sheets will turn to white colour.

On the left of the sheet tab, four navigation buttons are used to move between worksheets (Figure 7.9).



- (1) Move to the First sheet
- (2) Move to the previous sheet
- (3) Move to Next sheet
- (4) Move to the Last sheet

*Fig. 7.9 Calc Sheet tab and Navigation buttons*

Left corner of status bar shows the total count of sheets and the present active sheet number. For example, if the status bar shows sheet 3/12; 3 refers to the serial number of the current sheet and 12 refers to the total number of sheets available.

Every sheet name can be renamed. To rename a sheet, just double-click on the sheet, which will show a small box as shown in Figure 7.10.

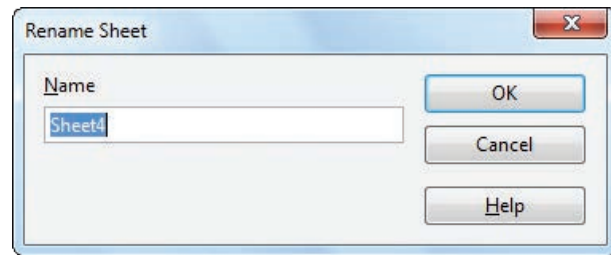

*Figure. 7.10 Rename Sheet dialog box*

It shows the current name; delete or overwrite the existing name and type a new name; click OK button. New name will be displayed on the sheet.

### 7.3.1.8 Status bar

Below the sheet tabs and horizontal scrolling bar is the “Status Bar”. It shows the current status of the worksheet (Refer Figure 7.11).

**Sheets count:** Displays current serial number of the sheet / total number of sheets available.

**Page Style:** Displays the page style of the current sheet. To make changes, just double-click on “Default” and it will show you the “Page Style” dialog box, which is used to change the margin, orientation, paper size, inserting header, footer, border style etc.,

**Selection Mode:** Displays the selection mode of the current sheet. There are three modes available to select the cells of a worksheet. They are, Standard (STD), Extend (EXT) and Add (ADD).

**Unsaved Changes:** An asterisk ( \* ) symbol indicates the changes made in the worksheet but not yet saved. If you have saved your changes, it will disappear.

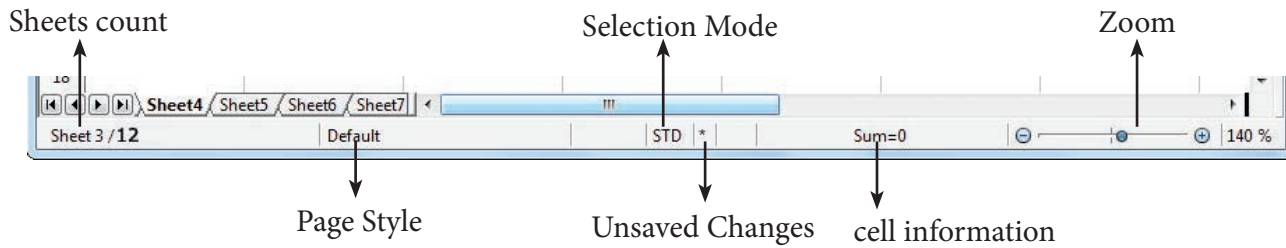

Fig. 7.11 Calc Status bar

## 7.4 Working with Data

When you open a new spreadsheet, the cell pointer is located in cell A1. So, the Cell A1 is known as “**Home Cell**”. Cell pointer can be moved anywhere in the spreadsheet using the direction keys.

“**Tab key**” is used to move the cell pointer towards the right side or forward direction. “**Shift+Tab**” is used to move backward i.e. from right to left in a row. “**Enter**” key is also used to move the cell pointer. Enter moves the cell pointer to a cell below the current cell i.e. downwards. Four “direction keys” are used to move the cell pointer anywhere in the worksheet.

### 7.4.1 Entering Data:

Any data can be typed directly in any cell of the worksheet. But, the cell in which you type data should be an active cell. So, move the cell pointer to a particular cell to make it active cell; or click any cell to make it active cell. Then, start typing any data. When you type data, spreadsheet recognises the type of data entered in cells.

#### Data types:

Data are in different types. Data are made up of alphabets, numbers, Date and time is another data type even though

it has numbers and symbols. In general, data types are classified as:

**Alphabetic data type** – consists of alphabets only  
**Numeric data type** – consists only of numbers (whole number or fractional numbers)  
**Alphanumeric data types** – consists of a combination of alphabets and numerals  
**Date data type** – consists only of date  
**Time data type** – consists only time

#### 7.4.1.1 Entering Numbers:

Any numeric data can be entered in a spreadsheet. Entered numbers are aligned to the right side within the cell by default. Negative numbers may be entered with a minus sign or within brackets (Refer Figure 7.12). If you enter any number within the bracket, it will be changed as negative number i.e., number prefixed with minus. If any number starts with 0 (zero); Calc will drop the leading zero.

 A screenshot of a spreadsheet showing data entry. The formula bar at the top shows the value '5478'. Below it, a grid of cells is visible. Column C is highlighted. Cell C1 contains the number '5478'. Cell C2 contains the number '-142'. The grid shows columns B, C, D, and E, and several rows.

Figure 7.12 Entering data

### 7.4.1.2 Entering Text:

Unlike numbers, any character can be entered as data in Calc. Entered text will be aligned to the left side within the cell by default. When you enter any numeric value, if it has aligned left, it is understood that the entered content is not a number. If there is any number that starts with a single quote, calc converts that number to text (Refer Figure 7.13).

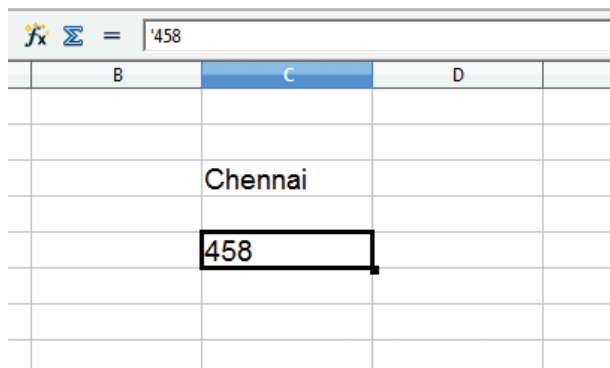

Figure 7.13 Entering Text

### 7.4.1.3 Entering Date and Time:

Before entering date, ensure the format of your system date. Calc accepts date as per the system date format. If your system has American date format i.e. month-date-year; you should enter dates in Calc spreadsheet as mm/dd/yy. If your system follows the Indian date format, date should be entered as dd/mm/yy form in Calc. Only the correct form of date is accepted by Calc as a date.

For example: If your system has American Date format, 18th December 2017 should be entered as 12/18/17. As soon as the date is typed in the correct form, the entered date will be aligned on the right side within the cell, and if you place the cell pointer in that cell, the formula bar shows your date as “12/18/2017”

(Figure 7.14). This is a visual clue to know whether the date is accepted or not.

A Date format can be changed to any other valid form using “Cell Formatting” dialog box, and it will be discussed later.

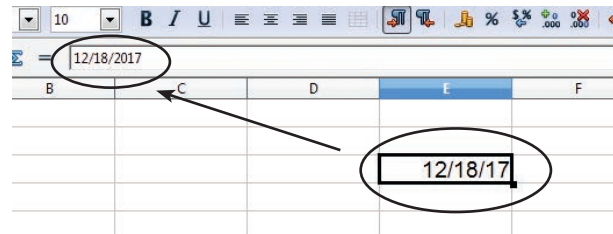

Fig. 7.14 Entering Date

Like dates, for entering time, calc follows the general format HH:MM:SS. where HH, MM and SS represent hours, minutes and seconds respectively.

### Different Date Formats

Order styles	Countries
DD/MM/YYYY	Asia (Central, SE, West), Australia, New Zealand, parts of Europe, Latin America, North Africa, India, Indonesia, Bangladesh and Russia
YYYY/MM/DD	Bhutan, Canada, China, Korea, Taiwan, Hungary, Iran, Japan, Lithuania, Mongolia.
MM/DD/YYYY	United States, Federated States of Micronesia, Marshall Islands
DD/MM/YYYY and MM/DD/YYYY	Malaysia, Nigeria, Philippines, Saudi Arabia, Somalia
DD/MM/YYYY and YYYY/MM/DD	Afghanistan, Albania, Austria, Czech Republic, Germany, Kenya, Macau, Maldives, Montenegro, Namibia, Nepal, Singapore, South Africa, Sri Lanka, Sweden.

## 7.5 Creating Formulae

After entering the data in worksheet, you can perform calculations on the data in the worksheet. In order to create formulae, you first need to know the syntax that describes the format for specifying a formula.

In Calc, you can enter formulas in two methods, either directly into the cell or at the input line. Formula in Calc may start with equal (=) or plus(+) or minus(-) sign followed by a combination of values, operators and cell references. But, as a general practice, all formulas should start with an equal sign. If any formula starts with a + or -, the values will be considered as positive or negative respectively.

### 7.5.1 Operators

Operators are symbols for doing some mathematical, statistical and logical calculations. Combination of values, operators and cell references is called as "Expression". Calc supports a variety of operators which are categorized as:

- (1) Arithmetic Operators
- (2) Relational Operators
- (3) Reference Operators
- (4) Text Operator

### 7.5.1.1 Arithmetic Operators

Arithmetic operators are symbols for performing simple arithmetic operations such as addition, subtraction, multiplication, division etc.,. These operators return a numerical result.

Operator	Name	Value in Column B	Value in Column C	Formula in Column D	Result in Column D
+	Addition	98	25	= B3 + C3	123
-	Subtraction	125	25	= B3 - C3	100
*	Multiplication	25	5	= B3 * C3	125
/	Division	90	10	= B3 / C3	9
^	Exponent	25	2	= B3 ^ C3	625
%	Percent	600		= B3 * 35%	72

Percentage (%) operator shows percentage of the content.

Table 7.1 List of Arithmetic Operators

Formula bar shows the formula what the user had entered. But, the cell shows the resulted value (Figure 7.15).

	A	B	C	D	E
1					
2					
3	Addition	98	25	123	
4	Subtraction	125	25	100	
5	Multiplication	25	5	125	
6	Division	90	10	9	
7	Exponent	25	2	625	
8	Percentage	600		72	
9					
10					

Figure 7.15 Percentage Operator

### 7.5.1.2 Relational Operators

Relational operators are symbols used for comparing two values such as greater than, less than, equal to etc. The relational operators are also called as "**Comparative operators**". These operators return either a True or a False.

Operator	Name	Value in Column B	Value in Column C	Formula in Column D	Result in Column D
>	Greater than	98	100	=B3>C3	FALSE
>=	Greater than or equal to	85	72	=B3>=C3	TRUE
<	Less than	54	24	=B3<C3	FALSE
<=	Less than or equal to	55	55	=B3<=C3	TRUE
=	Equal to	12	12	=B3=C3	TRUE
<>	Not equal to	54	45	=B3<>C3	TRUE

Table 7.2 List of Relational Operators of cells.

### 7.5.1.3 Reference Operator

Reference operators are used to refer cell ranges. A **continuous group of cells is called as “Range”**. There are three types of reference operators that are used to refer cells in calc; they are (1) Range Reference Operator, (2) Range Concatenation (3) Intersection Operator.

#### Range Reference Operator

Colon (:) is the range reference operator. It is used to group a range of cells. An expression using a range operator has the following syntax:

**reference left : reference right**

where reference left is the starting cell address of a linear group of cells or upper left corner address of a rectangular group

Reference right is the last cell address of a linear group or lower right corner address of a rectangular group of cell.

	A	B	C	D
1				
2				
3	Greater than	98	100	FALSE
4	Greater than or equal to	85	72	TRUE
5	Less than	54	24	FALSE
6	Less than or equal to	55	55	TRUE
7	Not equal to	12	12	TRUE
8		54	45	TRUE
9				
10				

Figure 7.16 Entering Relational Operator

**Example:**

- (i) Linear group of cells A1, A2, A3, A4, A5 is referred as A1:A5
- (ii) Rectangular group of cells A2, A3, A4, ..... B2, B3, B4, .... D5, D6 is referred as A2:D6 (Refer Figure 7.17)

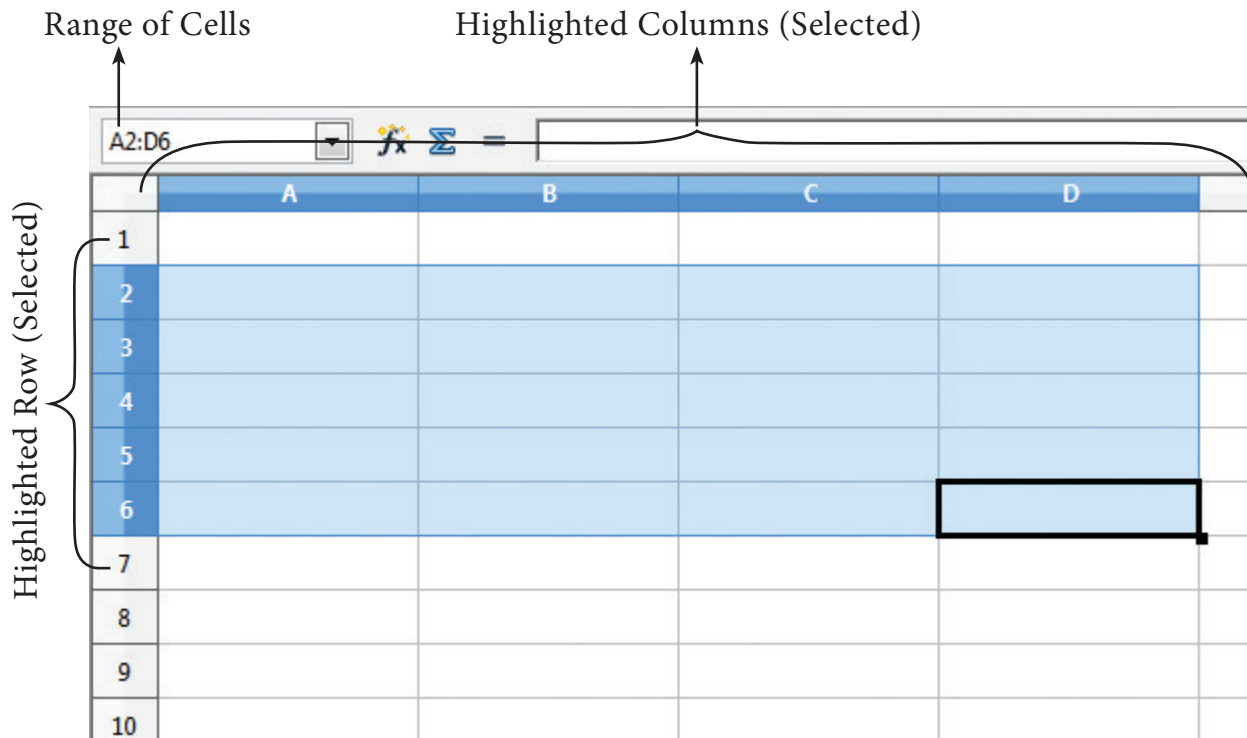

Figure 7.17 Range of selected cells

Name box shows the reference A2:D6 corresponding to the cells included in the drag operation with the mouse to highlight the range.

**Reference concatenation operator:**

Concatenation means joining together. Tilde (~) symbol is used as a concatenation operator in calc. An expression using a concatenation operator has the following syntax:

**reference left ~ reference right**

**Example:**

If you want to find the sum of the values from A1 to A6 and C3 to F3. The formula is =SUM(A1:A6 ~ C3:F3)

SUM is a function to find the sum of a group of values.



**Intersection Operator:**

Intersection operator is used to join two set of groups. It is very similar to Range concatenation operator. The intersection operator is represented by an exclamation

*reference left ! reference right*

**Example:** (A2:D3 ! B2:E4)

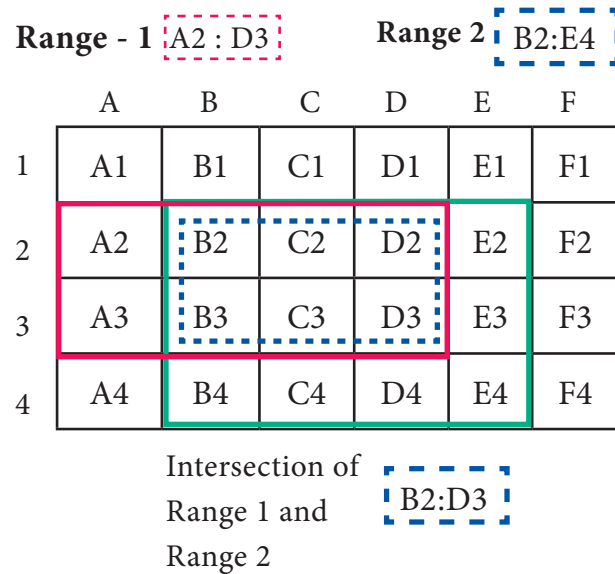

Figure 7.19 Intersection operator

The result of (A2:D3 ! B2:E4) is referred by the range B2:D3, because these cells are both inside A2:D3 and B2:E4 (Refer Figure 7.19 and 7.20).

	A	B	C	D	E
1					
2	28	78	45	25	52
3	47	65	68	18	80
4	65	92	24	67	67
5					
6	Sum of A2 to D3			374	
7	Sum of B2 to E4			681	
8	Sum of Intersection of (A2:D3) and (B2:E4) ie. (B2:D3)				299
9					

Figure 7.20 Worksheet with Intersection operator

### 7.5.1.4 Text Operator:

In Calc, “&” is a text operator which is used to combine two or more text. Joining two different texts is also known as “Text Concatenation” (Refer Figure 7.23). An expression using the text operator has the following syntax:

*text reference1 & text reference2*

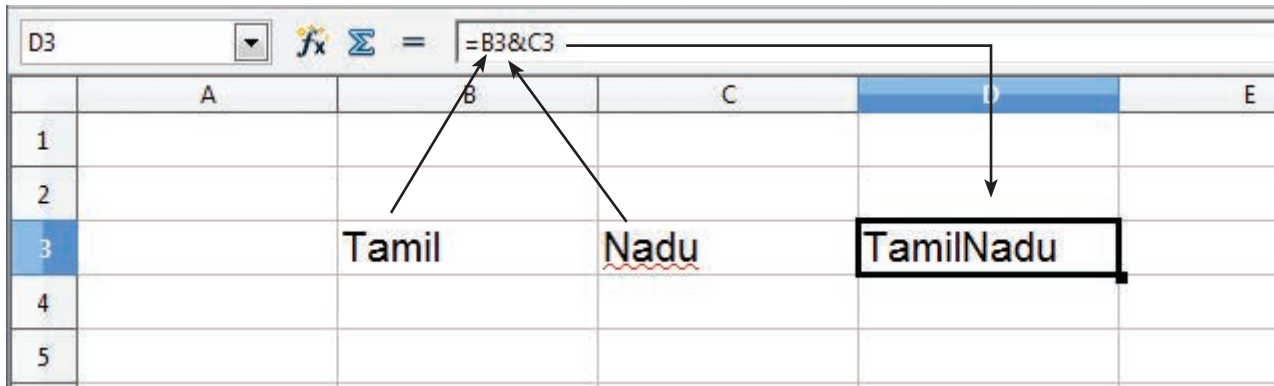

Figure 7.21 Text operator

When arithmetic operators are used in a formula, Calc calculates the results using the rule of precedence followed in Mathematics. The order is:

- I. Exponentiation ( ^ )
- II. Negation ( - )
- III. Multiplication and Division ( \*, / )
- IV. Addition and Subtraction ( +, - )

Here is an example to illustrate how to create a formula:

#### Illustration 1:

Create a Marks worksheet with the following data:

Reg. No	Name	Tam	Eng	CS	Com	Acc
12001	Jayashree J	147	136	105	163	162
12002	Kowsalya T	156	148	149	147	179
12003	Muskan S	149	165	123	168	179
12004	Ashia Stephy R	168	144	146	192	167
12005	Vennila T P	199	198	150	200	200
12006	Deepika M	187	141	98	130	178
12007	Tharani J	165	102	100	192	192
12008	Thulasi A	143	169	88	176	173
12009	Ayisha B	120	138	109	182	167
12010	Jenifer A	145	135	95	180	185

After completing the data entry, your worksheet will look as shown in Figure 7.22.

	A	B	C	D	E	F	G	H
1	Reg. No	Name	Tam	Eng	CS	Com	Acc	
2	12001	Jayashree	147	136	105	163	162	
3	12002	Kowsalya	156	148	149	147	179	
4	12003	Muskan S	149	165	123	168	179	
5	12004	Ashia Step	168	144	146	192	167	
6	12005	Vennila T	199	198	150	200	200	
7	12006	Deepika M	187	141	98	130	178	
8	12007	Tharani J	165	102	100	192	192	
9	12008	Thulasi A	143	169	88	176	173	
10	12009	Ayisha B	120	138	109	182	167	
11	12010	Jenifer A	145	135	95	180	185	
12								

Figure 7.22 Worksheet Illustration

### 7.5.2 Construction of formula

To construct a formula, follow the steps below:

- Cell pointer should be in the cell in which you want to display the result.
- Formula should begin with an = sign.
- In a formula, use only cell reference (cell addresses) instead of the actual values within the cells.
- While constructing a formula, **BODMAS rule** should be kept in mind.
- General Syntax of constructing a formula is: = *cell reference1* <operator> *cell reference2* <operator> .....
- Cell references are of two types (i) Relative cell reference (ii) Absolute Cell reference.
- If you refer cell addresses directly while constructing formulae, it is called as “Relative Cell reference”.
- Examples of Relative Cell references:

Adding values of A1, B1, C1, D1	=A1+B1+C1+D1
Subtract E4 from H3	= H3 - E4
Multiply A5 and B5	= A5 * B5
Average of G1, G2, G3, G4	=(G1+G2+G3+G4)/4

- In the above table, all cell references are “Relative cell references”.
- While writing a formula, if you use the \$ symbol in front of a column name and row number, it will become an “Absolute Cell reference”.
- Examples of Absolute cell references:

Adding values of A1, B1, C1, D1	= $\$A\$1+\$B\$1+\$C\$1+\$D\$1$
Subtract E4 from H3	= $\$H\$3 - \$E\$4$
Multiply A5 and B5	= $\$A\$5 * B5$
Average of G1, G2, G3, G4	= $(\$G\$1+G2+\$G\$3+G4)/4$

- In an expression, all cells need not necessarily be relative or absolute. You can mix both type of references.
- The following section explains the use of relative cell reference. About “Absolute cell reference”, you will be learn later in this chapter.

#### **Finding Total to the above Illustration:**

- Move the cell pointer to H2 (Total column)
- Type the following formula; after entering the formula, press “Enter” key  
= C2+D2+E2+F2+G2 (Refere Figure 7.25)
- Now, you will get the sum of all the values of C2, D2, E2, F2 and G2
- The above-mentioned formula clearly stated that, how worksheets are working with cells.
- While referring to the cell addresses in a formula, the spreadsheet reads the value inside the cell that you refer. This is a good practice of constructing a formula. Because, if you change any value, the spreadsheet recalculates with that new value.

After entering a formula the result is display as in Figure 7.23

	A	B	C	D	E	F	G	H
1	<b>Reg. No</b>	<b>Name</b>	<b>Tam</b>	<b>Eng</b>	<b>CS</b>	<b>Com</b>	<b>Acc</b>	<b>Tot</b>
2	12001	Jayashree J	147	136	105	163	162	713
3	12002	Kowsalya T	156	148	149	147	179	
4	12003	Muskan S	149	165	123	168	179	
5	12004	Ashia Stephy R	168	144	146	192	167	
6	12005	Vennila T P	199	198	150	200	200	
7	12006	Deepika M	187	141	98	130	178	
8	12007	Tharani J	165	102	100	192	192	
9	12008	Thulasi A	143	169	88	176	173	
10	12009	Ayisha B	120	138	109	182	167	
11	12010	Jenifer A	145	135	95	180	185	
12								

Figure 7.23 Constructing formula in Worksheet

## 7.6 Save, Close and Open the Worksheet:

### 7.6.1 Saving Worksheet

The process of saving a worksheet is very similar to saving a document. Steps to save a worksheet are as follows:

**Step 1:** File → Save (or) Ctrl + S (or) Click “Save” icon on the standard tool bar.

**Step 2:** If the spreadsheet has not been saved previously, the Save As dialog box will appear.

**Step 3:** Type the name in “File Name” list box. OpenOffice Calc Spreadsheets are stored with extension .ods by default.

**Step 4:** Click “Save” button.

After clicking the save button, the given file name is displayed in the title bar as shown in Figure 7.24

#### File Extension:

A file extension or file name extension helps to identify the type of file. Following table gives the file extension of commonly used files.

Familiar File Type	Extension
Text Files	.txt
Microsoft Word Documents	.doc / .docx
OpenOffice Documents	.odt
Microsoft Excel	.xls / .xlsx
OpenOffice Calc	.ods
Microsoft PowerPoint	.ppt / .pptx
OpenOffice Impress	.odp
Executable Files / Applications	.exe
Web Pages	.htm / .html
Portable Document Format	.pdf
Photos	.jpg / .jpeg (Joint Photographic Experts Group)
Animated Images	.gif (Graphical Image Format)
Audio	.mp3
Audio / Video	.mp4

File Name                      Application Name

↑    ↑

	A	B	C	D
1	<b>Reg. No</b>	<b>Name</b>	<b>Tam</b>	<b>Eng</b>
2	12001	Jayashree J	147	136
3	12002	Kowsalya T	156	148
4	12003	Muskan S	149	165
5	12004	Ashia Stephy R	168	144

Figure 7.24 Saved Spreadsheet

Note: The saved file is stored in the "**Document folder**" by default.

**DO YOU KNOW?**

### What is save?

Technically saving is a process of transferring or shifting contents from primary memory (RAM) to Secondary storage medium such as Hard disk, Pen drive, memory chip etc.

### 7.6.2 Auto Save:

The OpenOffice saves a file at regular intervals. This is called as "**Auto Save**" feature. The default time interval is 15 minutes. It can be reduced even to one minute. If any unexpected shutdown occurs, this feature will recover your file.

### 7.6.3 Closing a Worksheet

After saving the worksheet; it remains open. So, you can continue to work with the spreadsheet. When the work is finished, you should save using File → Save (or) Click "Save" icon (or) Ctrl + S and then to close the worksheet using File → Close command (or) Press Ctrl + W.

### 7.6.4 Opening an existing worksheet

#### 7.6.4.1 Using Open dialog box

To reopen an existing worksheet, the File → Open command (or) "Open" icon (or) Ctrl + O can be used. An Open dialog box appears as shown in Figure 7.25 that is similar to "Save As" dialog box.

The name of the file to be opened can be chosen from the list or folder in which worksheet has been saved.

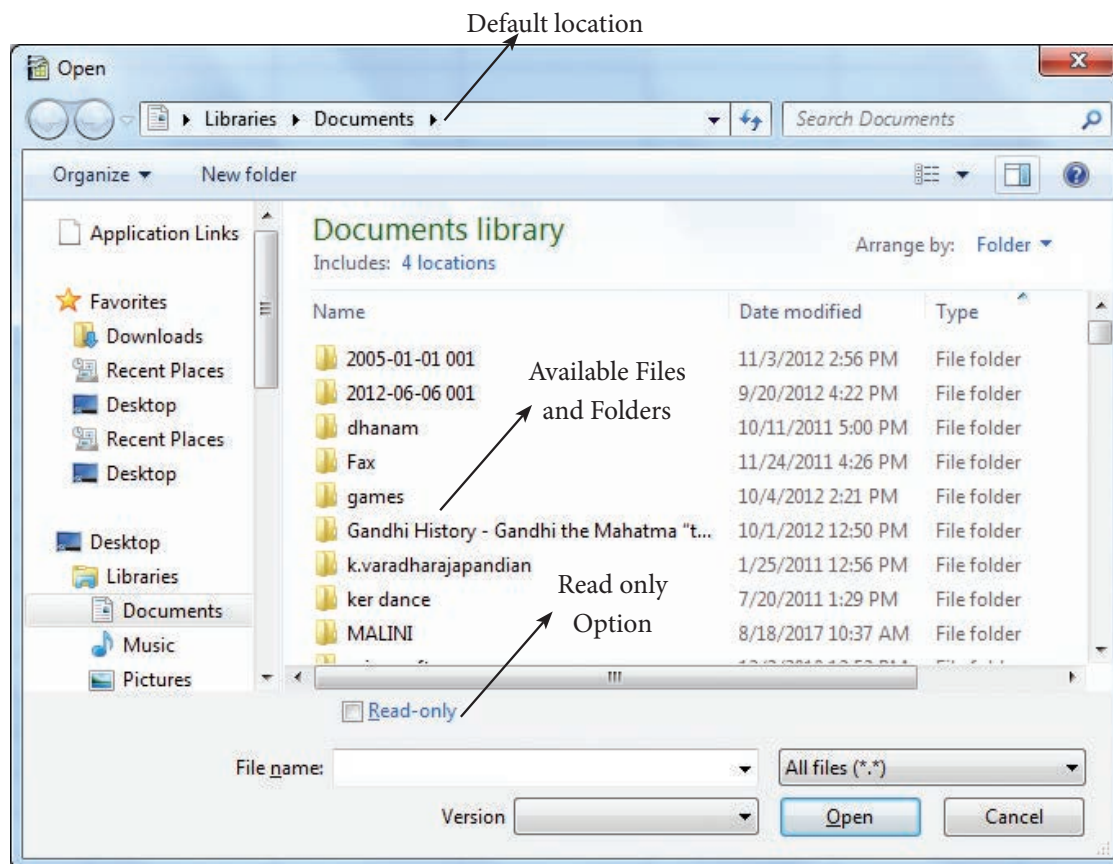

Figure 7.25 Open Dialog box

#### 7.6.4.2 Using Recent documents

OpenOffice keeps a list of recently opened files. **File** → **Recent Documents** option can be used to open an existing worksheet from the list as shown in Figure 7.26

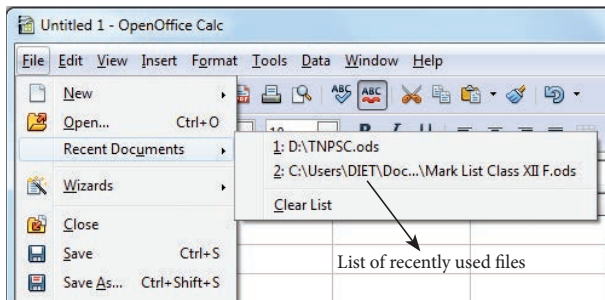

Figure 7.26 List of Recent Documents

### 7.7 Copy, Cut and Paste

#### 7.7.1 Copy and Paste Data

- Select the cell or cells you want to copy
- Select **Edit** → **Copy** or Click “Copy” icon from the standard toolbar or Press **Ctrl + C**

- Move the cell pointer to the cell in which you want to paste.
- Select **Edit** → **Paste** or Click “Paste” icon or Press **Ctrl + V**

#### 7.7.2 Cut and Paste Data

- Select the cell or cells you want to cut
- Select **Edit** → **Cut** or Click “Cut” icon from the standard toolbar or Press **Ctrl + X**
- Move the cell pointer to the cell in which you want to paste.
- Select **Edit** → **Paste** or Click “Paste” icon or Press **Ctrl + V**

#### 7.7.3 Copy and Paste Formula

- The process of Copy and Paste data is used for copying formula.
- When you copy a formula from one cell to another cell, the address of the pasted formula will change according to its row. This is called “Relative Cell Reference” (Refer Figure 7.27).
- Example:

While pasted it becomes = B3\* C3

	A	B	C	D	E
1	Product	Quantity	Unit Price	Total Price	
2	A	50	12.5	625	
3				0	
4		Row number			
5					
6					

Originally typed formula = B2\*C2

Figure 7.27 Copy and Paste formula to multiple cells



### 7.7.4 Copy a formula from one cell and paste it in multiple cells:

(For illustration 1 - Refer 7.23)

**Step 1:** Copy the formula from H2 using **Ctrl + C** or **Edit** → **Copy** (or) click “Copy” icon.

	A	B	C	D	E	F	G	H
1	<i>Reg. No</i>	<i>Name</i>	<i>Tam</i>	<i>Eng</i>	<i>CS</i>	<i>Com</i>	<i>Acc</i>	<i>Tot</i>
2	12001	Jayashree J	147	136	105	163	162	713
3	12002	Kowsalya T	156	148	149	147	179	779
4	12003	Muskan S	149	165	123	168	179	784
5	12004	Ashia Stephy R	168	144	146	192	167	817
6	12005	Vennila T P	199	198	150	200	200	947
7	12006	Deepika M	187	141	98	130	178	734
8	12007	Tharani J	165	102	100	192	192	751
9	12008	Thulasi A	143	169	88	176	173	749
10	12009	Ayisha B	120	138	109	182	167	716
11	12010	Jenifer A	145	135	95	180	185	740
12								

Figure 7.28 Copy and Paste formula to Multiple cells

**Step 2:** Select all cells (i.e. H3 to H11) in which you want to paste this addition formula.

**Step 3:** Paste the copied formula using **Ctrl + V** or **Edit** → **Paste** (or) Click “Paste” icon.

#### Self Practice:



1. Open the spreadsheet which was created in Illustration 1.
2. Add one more column heading “Average” in I1
3. Create a formula to find the average of all marks in I2.
4. Apply the formula to the remaining cells.
5. Save the changes and close the file

### 7.8 Auto Fill Feature:

You have learnt how to copy and paste a formula from one cell to other cells in the previous section. The process of Copy and paste can be replaced by a click and drag and it is called as “Auto Fill”. This is an alternate way to copy and paste.

Auto Fill feature fills the contents from one cell to all the dragged cells. The content may be a data or formula. If you fill a relative formula, all the addresses of filled formulae will be changed.

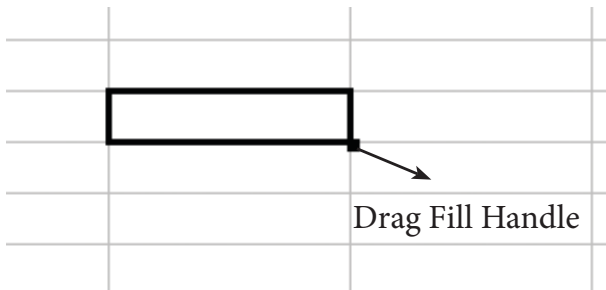

Figure 7.29 Drag fill handle

Cell pointer's "Drag fill handle" is used to auto fill. Just click and drag this handle to fill the contents. It can be dragged towards right or down. Same can be achieved by Edit → Fill → Down (or) Edit → Fill → Right.

### 7.8.1 Auto Fill Series:

Auto Fill is also used to generate a series of values. For example, if you want to generate 1,2,3..... up to some length; it can be done by a simple click and dragging over.

Generating whole number series:  
(Refer Figure 7.30)

**Step 1:**In cell A1, type as 1 (one) and press enter

**Step 2:**click A1 to place the cell pointer

**Step 3:**Click "Drag Fill Handle" of cell pointer; now the mouse pointer becomes a small +

**Step 4:**Drag over the cells; while dragging, the generated values will be displayed.

**Step 5:**Release the mouse pointer. Selected cells will be filled with series of values.

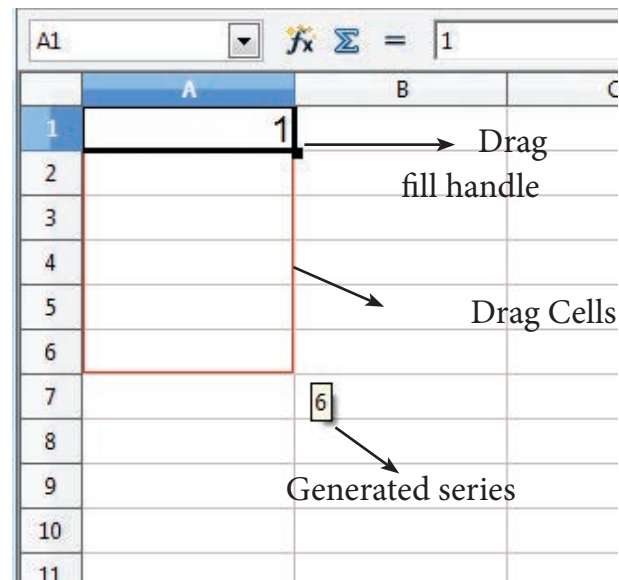

Figure 7.30 AutoFill series

### 7.8.2 Generating series using command

Edit → Fill → Series Command is used to generate different set of series. Before using this feature, a set of cells should be selected. Using Fill Series feature, you can fill series of values at any direction. (Remember that, auto fill only fills either right or down). Refer Figure 7.31

**Direction :** Down / Right / Up / Left  
(Selected cell direction will be default)

**Series type :**

**Linear :** To generate a sequence of series  
(Example 2,4,6,8,10.....)

**Growth :** To generate multiplication series  
(Example 2,4,8,16,32,64.....)

**Date :** To generate date series (when you select date as series type; time unit section gets enabled)

**AutoFill :** To generate a continuous series of values (1,2,3.....). When you select "AutoFill", Time unit section, End value and Increment text boxes become disabled.

**Time Unit:** (Enabled only when you select the series type as “Date”)

- Day : To generate date series day-wise
- Weekday : To generate date series weekday-wise
- Month : To generate date series month-wise
- Year : To generate date series year-wise

**Start Value:**

- Initial value of the series should be typed

**End Value:**

- End value of the series should be typed
- If you fail to specify the end value, series will be generated upto the selected cells.

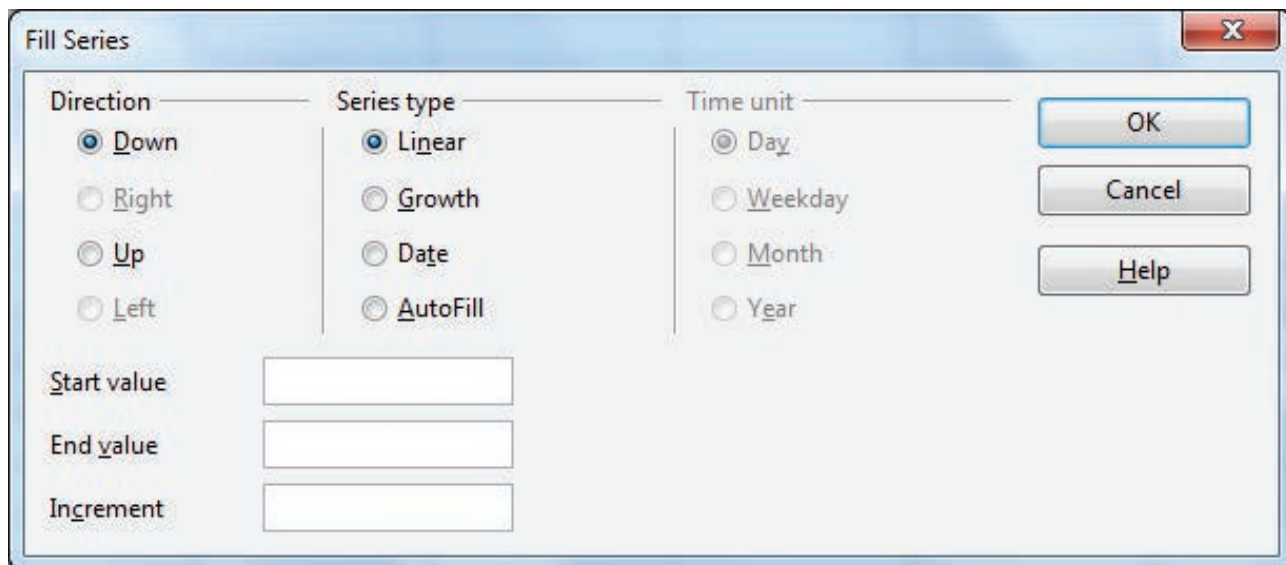

Figure 7.31 Fill series dialog box

- If your selection is less than the specified end value, series will be generated only upto the selected cells.

**Increment:**

- It is a middle value between the first and second value of your series. So, the next value (Third value) of the series will be generated based on this value.
- If you want to generate a decreasing order series, negative value should be specified as an increment value.

**Self Practice:**

- (i) Generate Even number series from 2 to 20
- (ii) Generate a series of 5, 10, 15, 20 ..... upto selected cells.
- (iii) Generate a series of 2,4,8,16,..... 2048
- (iv) Generate a series of 33, 30, 27 ..... upto 3
- (v) Assume, today is Friday and generate next 25 Fridays (Date series).

**7.8.3 Date Arithmetic:**

Manual date calculations can be tricky because you have to keep track of the number of days in a month. In spreadsheets, date calculations become very simple. Here you can add a number to a date and arrive at a new date, find the difference between two dates and use a wide variety of function and formats to get what you want.

For example, enter a date 02/26/2018 in a cell, say A2. Suppose you want to calculate the date 80 days after this date. To do so, enter the formula, = A2 + 80, in another cell, say A4.

The date 05/17/18 appears in the cell.

**Find out how many days you were born?**

- Type today's date in first cell.
- Type your birth date in second cell.
- Type the following formula in third cell = first\_cell\_reference - second\_cell\_reference

	B	C	D
Today		01/15/18	
My Birth Date		09/30/03	
No. of days		5221	

The formula bar shows: =C2-C3

## Part – II Editing and Formatting Worksheet

### 7.9 Inserting Columns, Rows and Cells

In Calc, Columns, rows and cells can be inserted individually or in groups.

#### 7.9.1 Inserting a Column:

When you insert a new column, it is inserted to the left of the current column. The location of the cell pointer present, is the Current column. In Calc, you can insert a new column anywhere in the worksheet.

**Step 1:** Select the column where a new column should be inserted.

**Step 2:** Right-click on the selected column name that you selected. A pop-up menu appears.

**Step 3:** click the “Insert Columns” option from the menu.

Now, a new column will be inserted to the left of the current column.

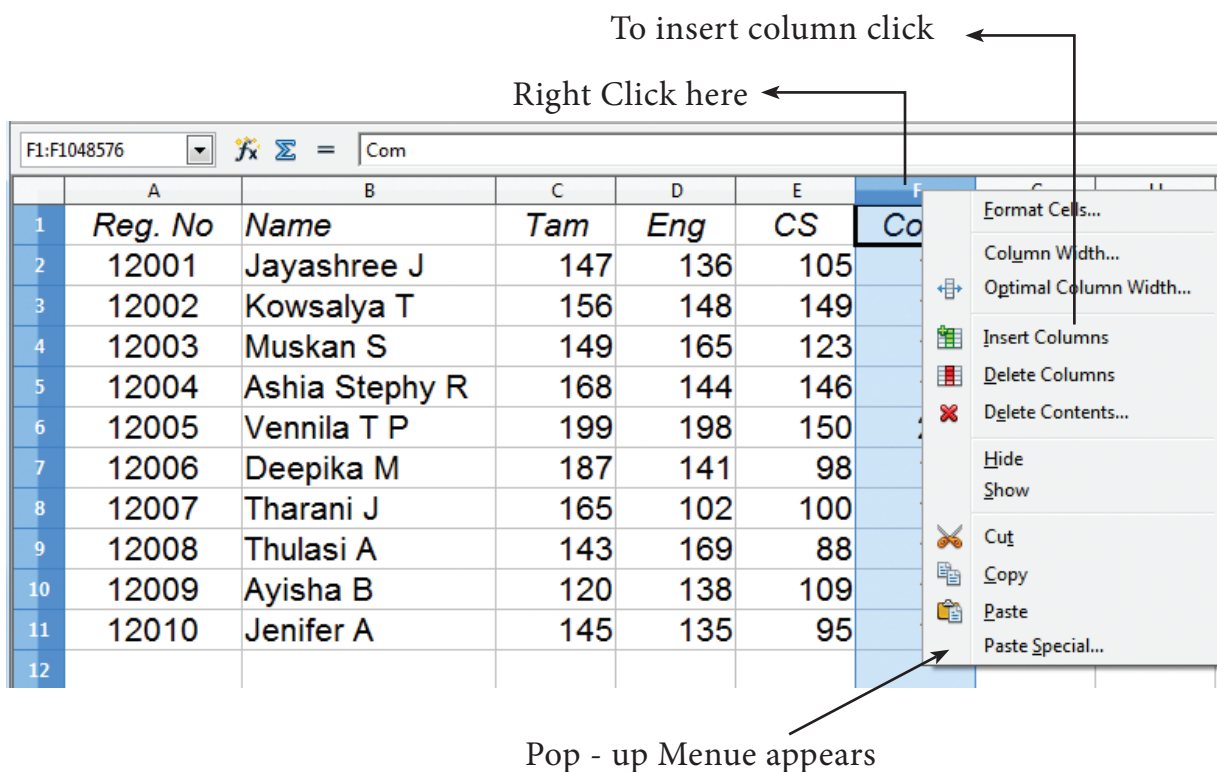

Figure 7.32 Insert Column pop-up menu

A new column can also be inserted using Insert → Columns command. (Refer Figure 7.32)

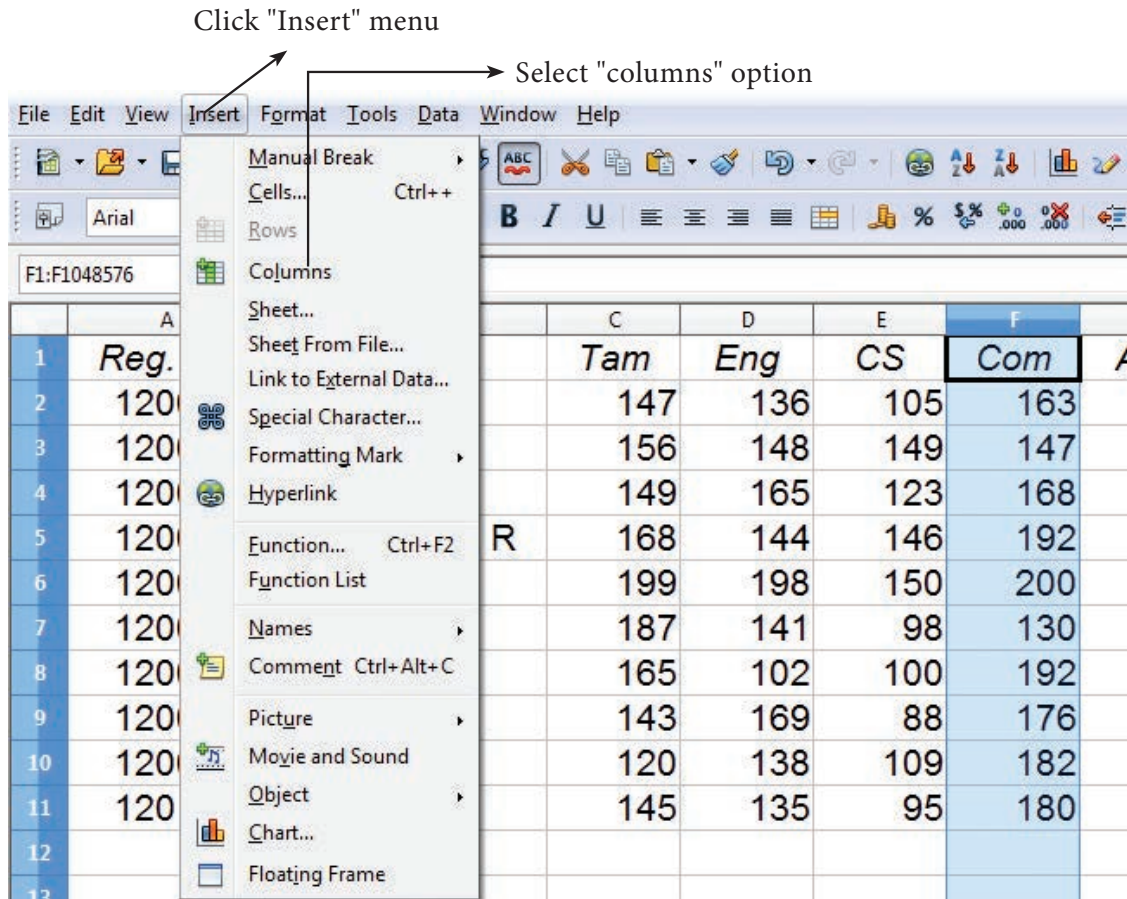

Figure 7.33 Insert Column menu bar

### Practical Practice:

1. Open the spreadsheet which was created in Illustration 1.
2. Insert a new column between column E and F
3. Give the heading as "Eco" and Enter the Economics marks for all the students
4. Insert one more column between the columns, Name and Tamil marks.
5. Give the heading as "Date of Birth" and Enter the date of birth for all the students.
6. Save the changes and close the file.

### 7.9.2 Inserting Rows

When you insert a new row, it is inserted above the current row. The location of the cell pointer present is the current row. In Calc, you can insert a new row anywhere in the worksheet.

**Step 1:** Select the row where a new row to be inserted.

**Step 2:** Right-click on the row number, a pop-up menu appears

**Step 3:** click "Insert Rows" option from the menu.

Now, a new row will be inserted to above the current row.

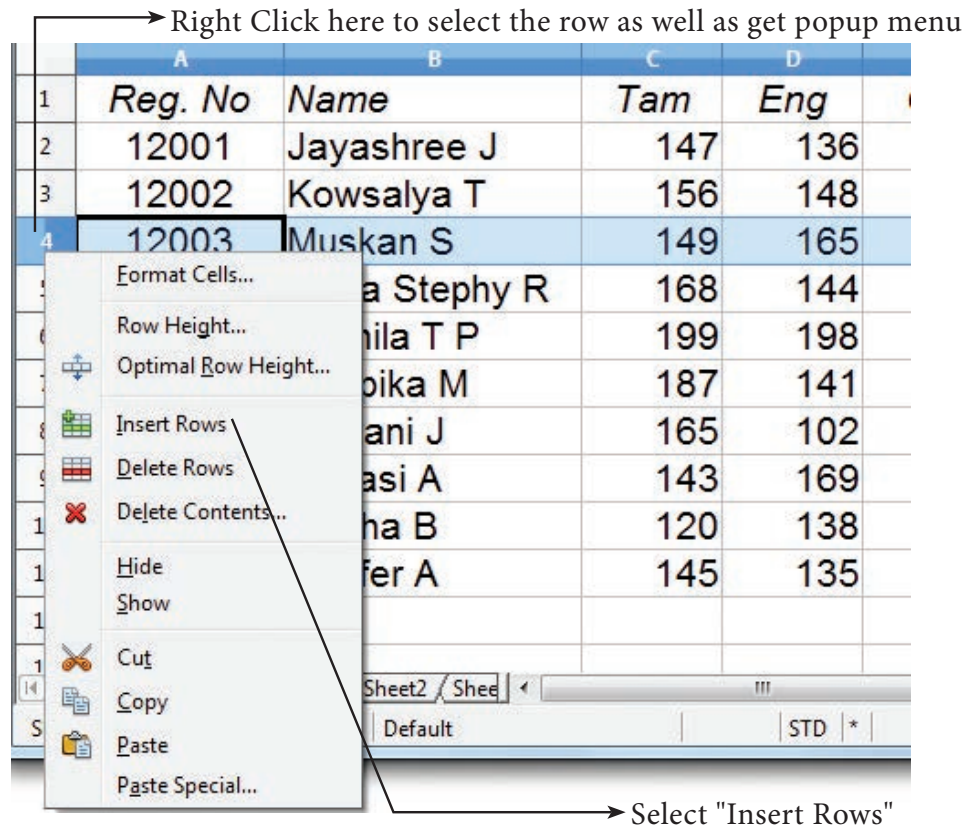

Figure 7.34 Insert Rows popup menu

**Insert** → **Rows** command is used to insert a new row. Refer Figure 7.35

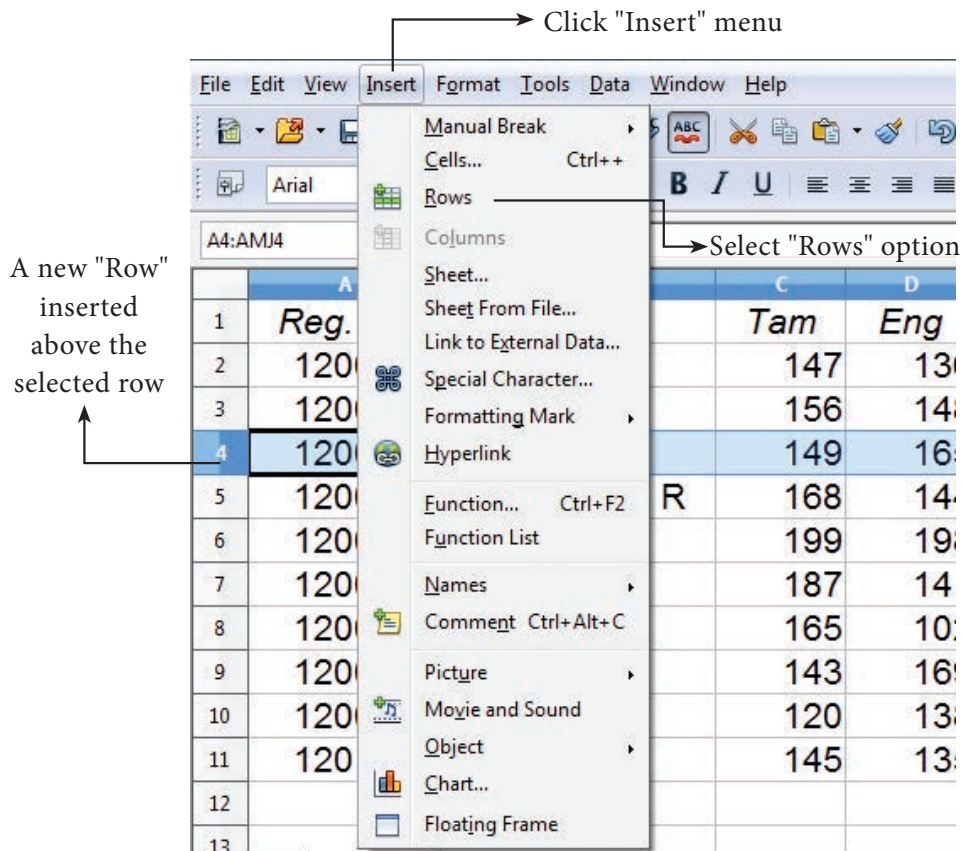

Figure 7.35 Insert Rows menu bar

**Self Practice:**

1. Open the spreadsheet which was created in Illustration 1.
2. Insert 8 rows one by one, then insert the following student details
3. Save the changes and close the file.

Reg. No	Name	Date of Birth	Tam	Eng	CS	Eco	Com	Acc
12101	Sarika S	26/05/2001	145	135	145	125	180	196
12102	Jeweess Celcya J	11/04/2001	102	165	134	95	180	134
12103	Yuvarani T	27/06/1999	172	130	107	155	162	130
12104	Meharunisha I	30/05/2001	132	146	112	185	192	176
12105	Priya W	07/03/2000	130	172	100	92	162	155
12106	Vijaya Vasavi K	03/06/2001	198	175	149	148	158	135
12107	Deepika B	14/03/2001	120	182	103	144	107	186
12108	Viji V	19/04/2001	137	173	128	148	125	177

**7.9.3 Inserting Cells**

- To insert a new cell between two existing cells, just right-click on any existing cell
- From the pop-up menu, select “Insert” option *Figure 7.36 Insert cells*
- The “Insert Cells” dialog box appear with four options
  - i) Shift cells down
  - ii) Shift cells right
  - iii) Entire row
  - iv) Entire Column
- Any one of the four options is selected.
- Selecting “Shift cells down”, inserts a new cell in the present location and the existing cells are shifted downwards.
- Selecting “Shift cells right”, inserts a new cell in the present location and the existing cells are shifted towards right.
- Selecting the “Entire Row” or “Entire Column” option, inserts a new row or a new column.v

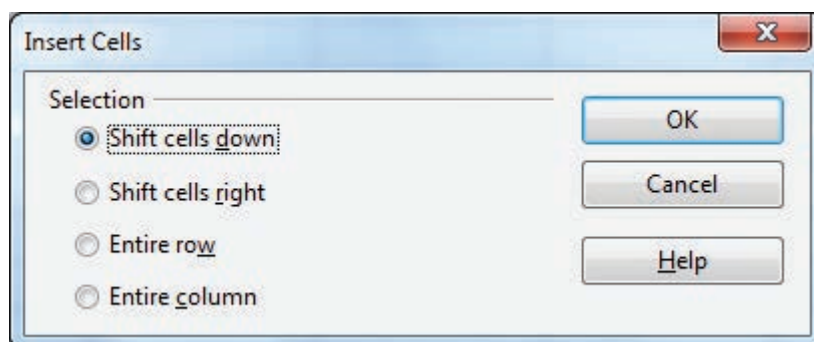
*Figure 7.36 Insert cells*



### 7.9.4 Inserting multiple columns or rows

Multiple columns or rows can be inserted at once rather than inserting one at a time.

- Select multiple rows or columns for insertion.
- Follow steps as in 7.9.1 and 7.9.2

### 7.9.5 Inserting Columns, Rows and Cells using “Insert Cells” Toolbar

- Insert Cells floating toolbar is also used to insert cells, rows and columns
- Click View → Toolbars → Insert Cell
- A tiny floating toolbar appears on the screen with four icons. Using these icons, you can insert cells, rows and columns. Refer Figure 7.37

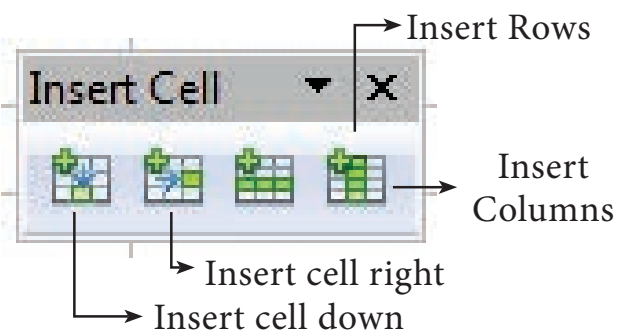

Figure 7.37 Insert cell tool bar

## 7.10 Deleting columns and rows

A single or multiple columns or rows can be deleted.

### **DO YOU KNOW?** Inserting a new Column or row is really possible in a Spreadsheet?

All spreadsheets have some specific number of rows and columns, then how can you insert an additional row or column. Is this possible?

**Technically this is NOT POSSIBLE.**

Additional column, row or even cell cannot be inserted in any spreadsheet. When you insert a column or row, the contents within the column or row will be shifted to the next column or row. But visually it is felt that a new column or row has been inserted.

### 7.10.1 Delete single column or row

A single column or row can be deleted by using the mouse:

- Select the column or row to be deleted.
- Choose Edit → Delete Cells from the menu bar.

(Or)

- Right-click on the column or row header.
- Choose Delete Columns or Delete Rows from the pop-up menu.

### 7.10.2 Delete multiple columns or rows

Multiple columns or rows can be deleted at a time. Refer Figure 7.38

- Select the required columns or rows for deletion.
- Right-click on the selected columns or row.
- Choose Delete Columns or Delete Rows from the pop-up menu or Edit → Delete Cells.

### Practical Practice:



1. Open the spreadsheet which was created in Illustration 1.
2. Delete the details of any 3 students. Save the changes and close the file.



### Deleting Column or Row is not Possible

Same as inserting column or row, Deleting a column or row is also not possible. No one can delete any column or row in a spreadsheet. When you delete a column or row, all the contents will be removed from the column or row. Actually, this is also another kind of deleting contents from a column or row.

## 7.11 Formatting Worksheet

Formatting Data in a cell gives additional effect to the text. Additional effect includes changing the font style, font size, automatic wrapping, bold, underline, italic etc. The data in Calc can be formatted in several ways. Using formatting icons can be used.

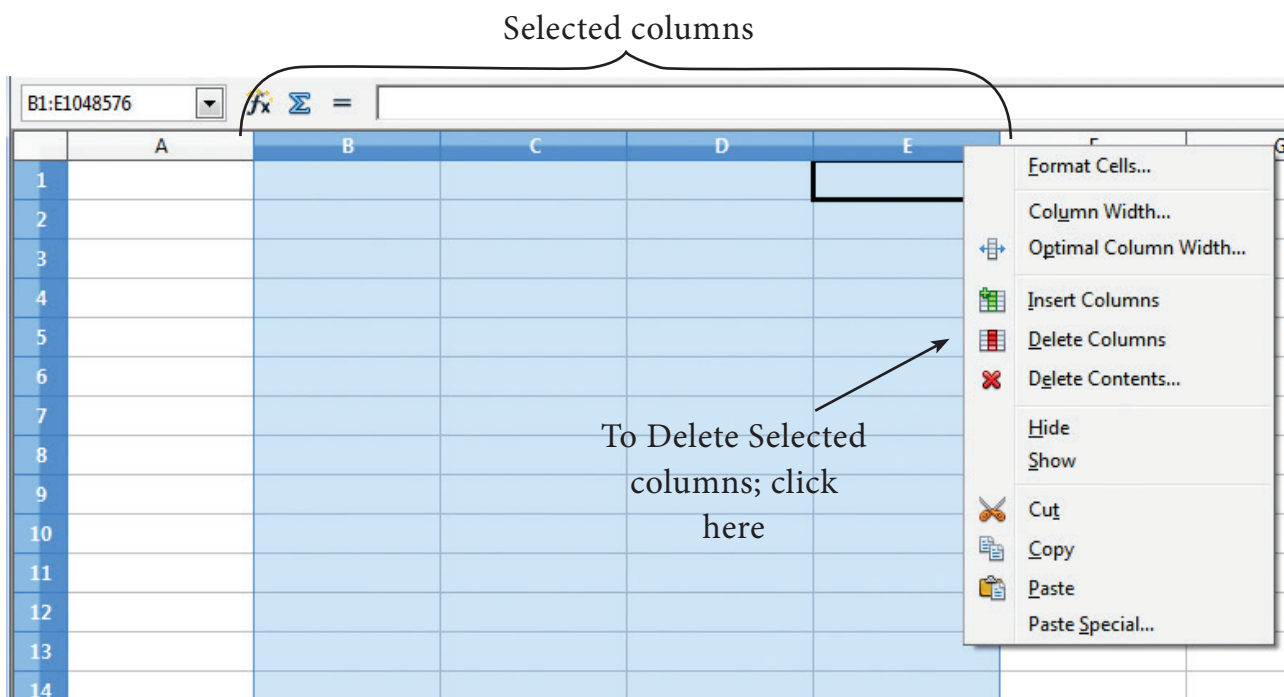

Figure 7.38 Delete multiple columns

### 7.11.1 Text Formatting

Making the cell contents as bold, italics, underlined, changing font style, size, colour etc., comes under text formatting. All text formatting options are available as icons in Formatting toolbar learnt in OpenOffice Writer. *Figure 7.39(a) Text Formatting Toolbar*

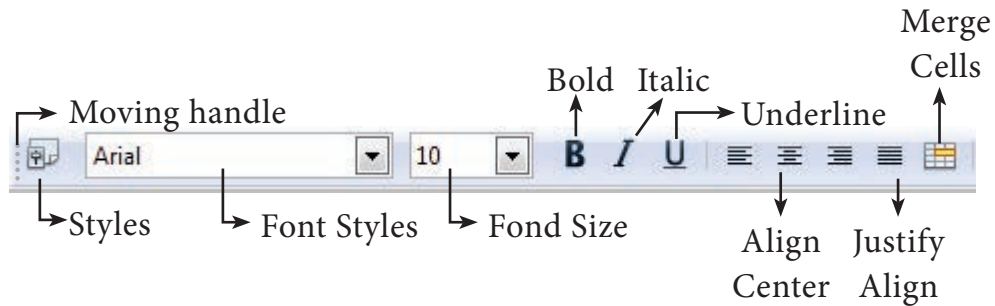

Figure 7.39(a) Text Formatting Toolbar

Formatting Option	Keyboard Shortcut	Description
Font style		Used to change Font style
Font size		Used to change Font size
Bold	Ctrl + B	Used to make the data as Bold
Italic	Ctrl + I	Used to italicize data
Underline	Ctrl + U	Used to underline the data
Left Align	Ctrl + L	Left Align data within a cell
Right Align	Ctrl + R	Right Align data t within a cell
Center Align	Ctrl + E	Center the data within a cell
Justify	Ctrl + J	Align the data evenly both on left and right side of a cell
Merge cell		Makes selected cells as a single cell

### 7.11.2 Number formatting

Number formatting options are used to visually change the format of a numeric content. These formatting changes are only for visual as, it does not change its original value. For example, To display a number as currency form use Number format: Currency.

Number format: Currency will be used as shown Figure 7.39(b).

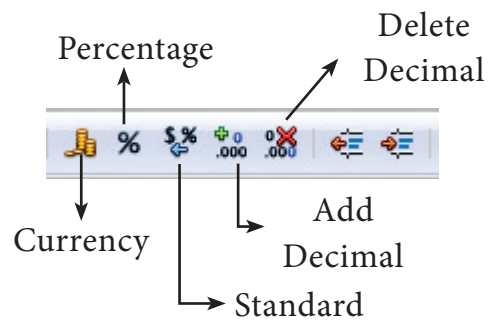

Figure 7.39(b) Formatting toolbar

Number Format	Keyboard Shortcuts
Currency Symbol	Ctrl+Shift+4
Percent	Ctrl+Shift+5
Standard	Ctrl+Shift+6
Add Decimal Place	
Delete Decimal Place	

**Practical Practice:**

1. Open the spreadsheet which was created in Illustration 1.
2. Align all headings as center and make them bold.
3. Align all Register numbers and marks in center
4. Apply different font styles to the entire worksheet.
5. Save the changes and close the file

## Part – III Working with Functions and Chart

### 7.12 Functions

OpenOffice Calc has more than 350 functions under 11 categories. Functions are predefined formulae already available with Calc. They are used to perform several frequently done calculations. Every function has a unique name and a prototype. Functions are categorized according to their functionality. For example, the functions such as Sum, Average, Sin, Cos etc., are categorized as “Mathematical Functions”.

#### 7.12.1 Inserting Functions into Worksheet:

A function can be inserted by (i) Direct Insert Method or (ii) Using Function Wizard method.

##### 7.12.1.1 Direct Insert method:

If you know the function name and its syntax, it can be directly typed in any cell of the worksheet.

For example, SUM is the most frequently used function to add a set of values. The syntax of the SUM ( ) is

**= SUM (range 1; range 2; range 3..... range n)**

If you want to know the sum of the values in A1, A2, A3, A4 and in A5, Place your cell pointer in A5 and directly type the formulae as follows.

**= SUM (A1:A4)**

While inserting a function the following points should be kept in mind.

1. A function should begin with an equal sign.
2. Use proper name for the function to be used.
3. Arguments should be given within the brackets as per the syntax. Each function has a unique argument list.
4. Press “Enter” key after typing the function.

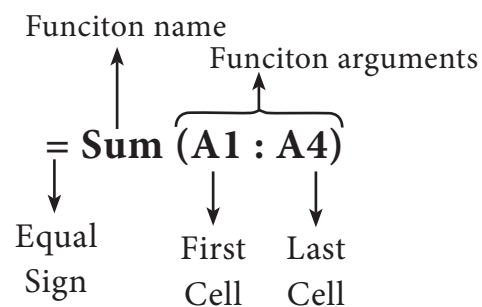

*Figure 7.40 Function Syntax*

**Self Practice:**

1. Open the spreadsheet which was created in Illustration 1.
2. Delete all the formula in Total column.
3. Use SUM function to add all the marks of each student.
4. Save the changes and close the file

**7.12.1.2 Using Function Wizard method**

A function can be inserted using Function Wizard in Calc. Function Wizard is a dialog box that provides the step-by-step procedure to insert a function. Function Wizard can be invoked by clicking the Function Wizard icon on the Formula bar (or) **Insert** → **Function** (or) **Ctrl + F2**. Refer Figure 7.41

**Function category drop down list box:**

Function Wizard has two tabs viz. Functions and Shortcuts. In Functions Tab, the list of categories is available in Category drop down list box. In Calc, the functions are categorized into 11 types. They are,

- |                |                  |              |                |
|----------------|------------------|--------------|----------------|
| 1. Database    | 2. Date and Time | 3. Financial | 4. Information |
| 5. Logical     | 6. Mathematical  | 7. Array     | 8. Statistical |
| 9. Spreadsheet | 10. Text         | 11. Add-in   |                |

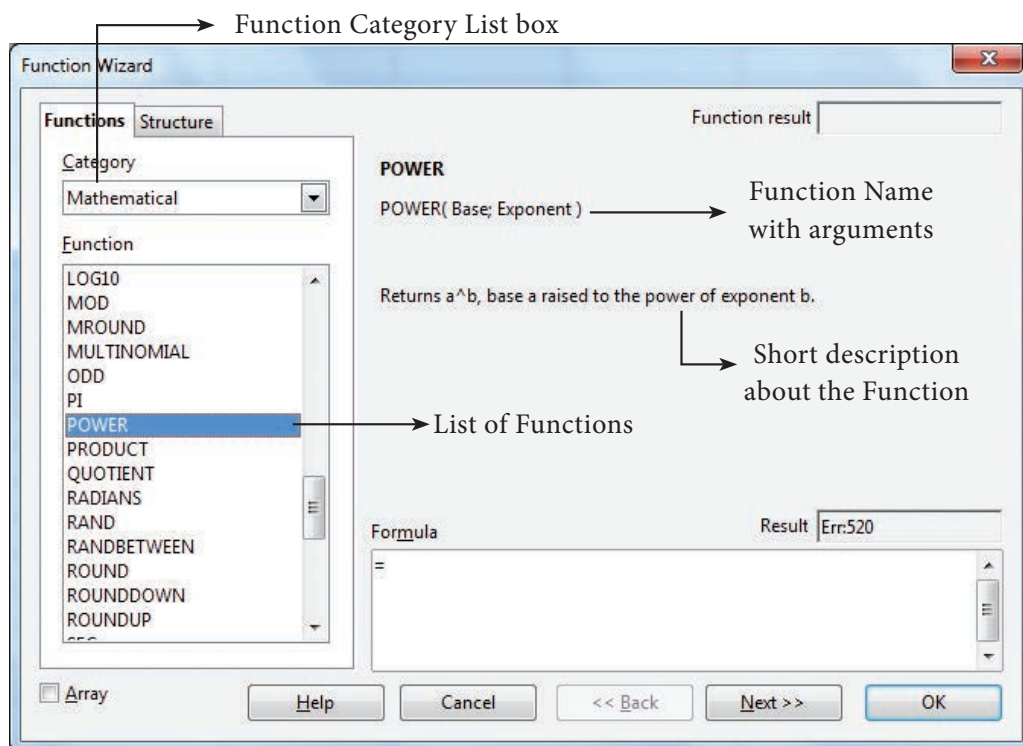

Figure 7.41 Function wizard

If you select any particular category, the Functions list box shows the functions which belongs to the selected category. If “All” is selected under category all functions in calc is displayed in alphabetical order. Refer Figure 7.42

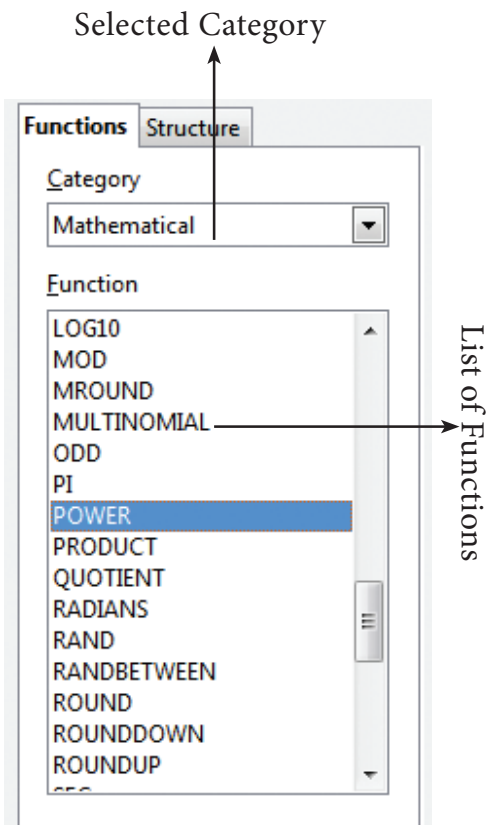

Figure 7.42 Function wizard – Function Category list box

### Function Description

When you select a function, the function wizard shows the function name, syntax and a small description about the function on the right side of the dialog box. Refer Figure 7.43

### Inserting a function using Function Wizard: (with Cell Reference)

The following steps explains to insert POWER ( ) function in a cell.

### About POWER ( ) function:

POWER ( ) is a function which is used to calculate power of an exponent value of a number. This function is categorized as a Mathematical function. There are two inputs needed to find the power value of a number. They are, Base value and exponent value. For example, to find the value of 25 to the power of 2 ( $25^2$ ) where 25 is the base value, 2 is the exponent value.

The syntax of POWER ( ) is = **POWER (Base ; Exponent)**

Both Base and Exponent are arguments. In Calc, arguments are separated by a semicolon.

### Inserting POWER ( ) in a worksheet:

**Step 1:** In cell A2 type the base value 25

**Step 2:** In cell B2 type the exponent value 2

**Step 3:** Move the cell pointer to C2; in which you want display result.

**Step 4:** Click *fx* icon from Formula bar (or) choose Insert → Functions (or) Press Ctrl + F2.

**Step 5:** Pull down category list box, Choose “Mathematical”

All function under Mathematical category is displayed in the “Functions” list box

**Step 6:** Scroll the “Functions” list box and select “POWER( )”. The function wizard shows the description about the selected function on the right corner of the dialog box

**Step 7:** Click “Next” command button. Now, Function wizard appears as shown in the Figure 7.44.

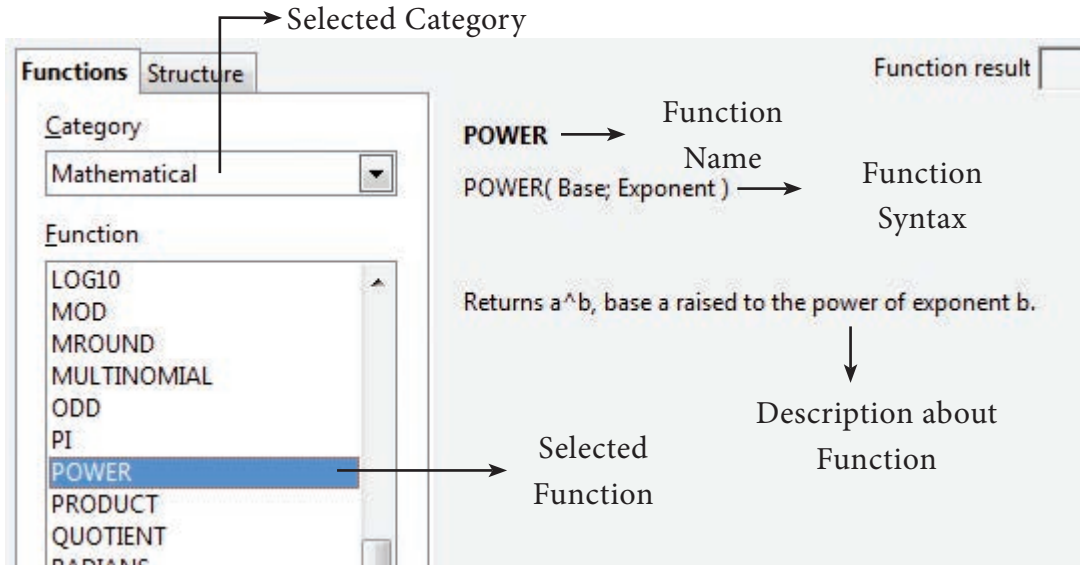

Figure 7.43 Function wizard dialog box

**Step 8:** Click on the cell which is contains the base value (A2).

Now, the minimized wizard shows the cell address you have selected (A2). Refer Figure 7.45

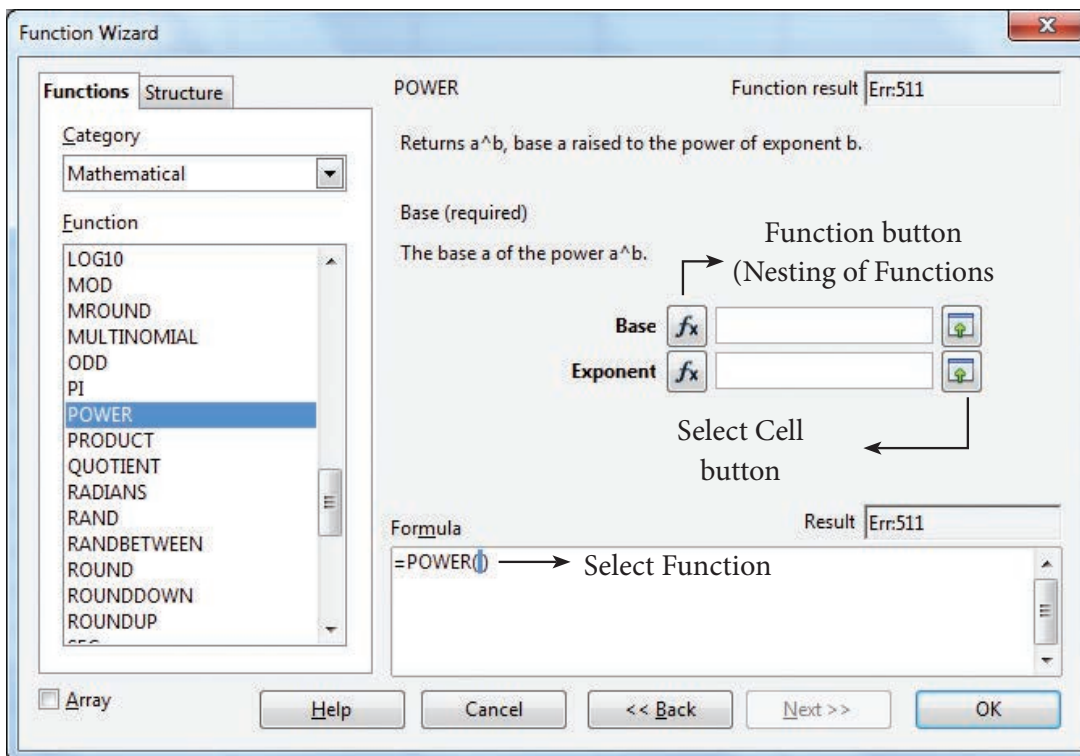

Figure 7.44 Function wizard

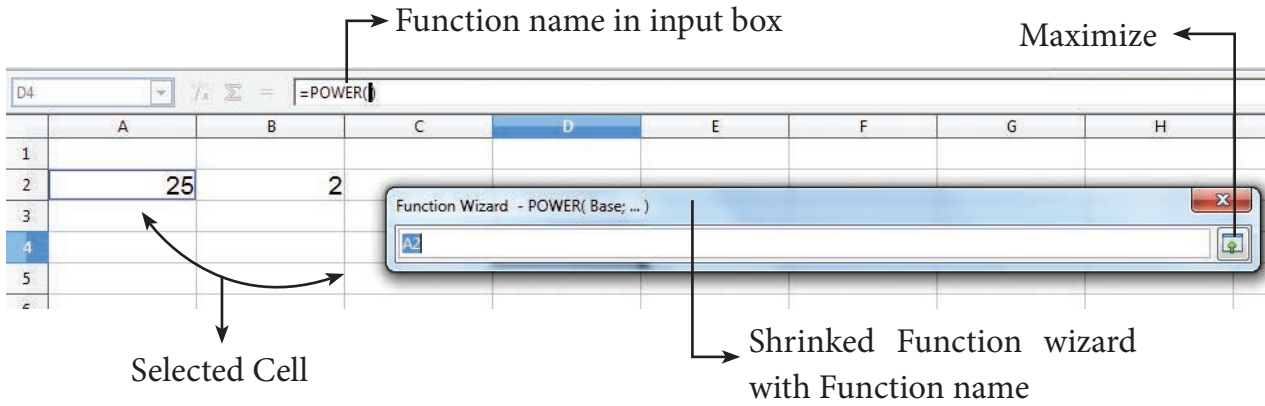

Figure 7.45 Function wizard

**Step 9:** Click “Maximize” button to display full wizard. Now, Function wizard appears as shown in Figure 7.46

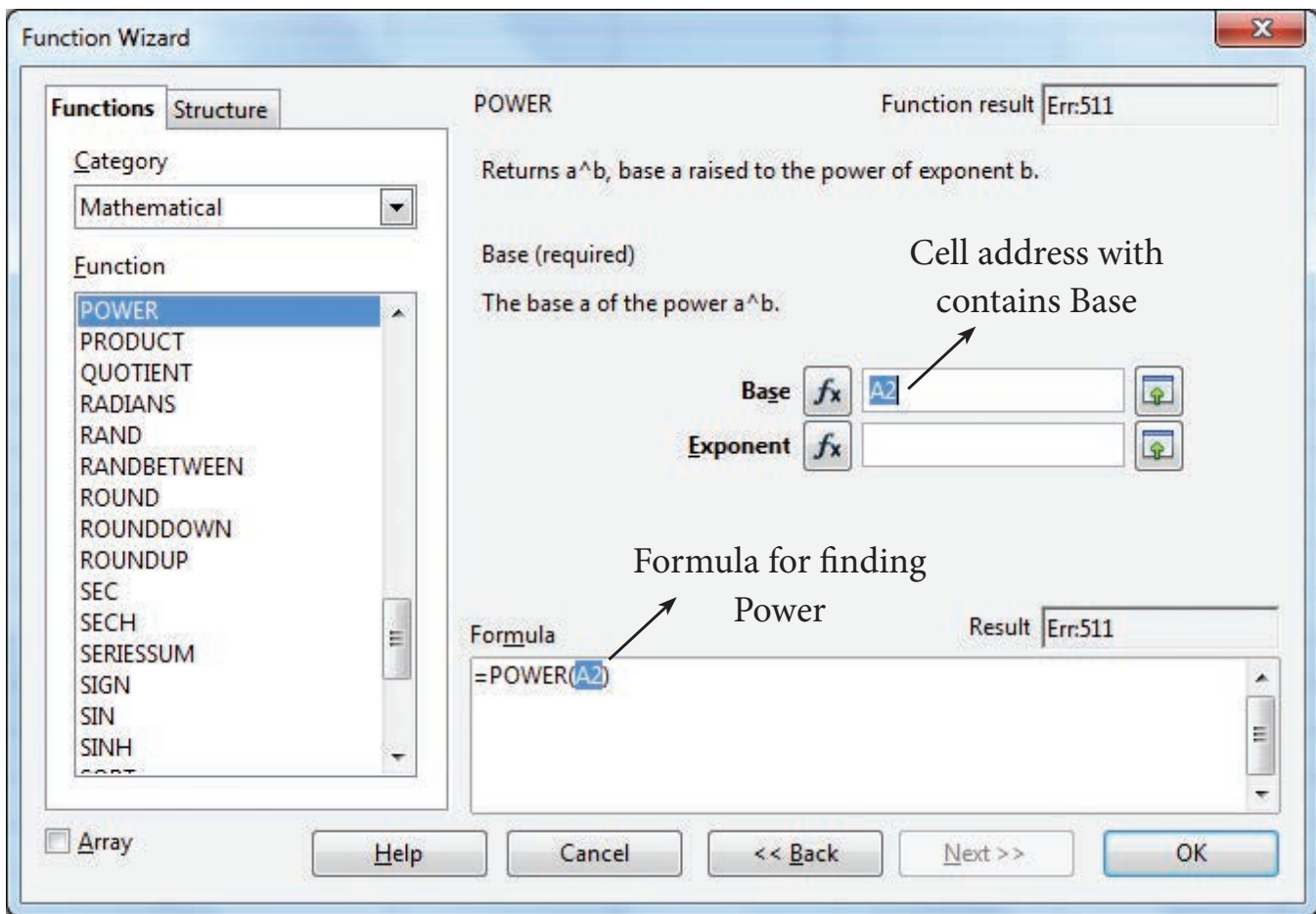

Figure 7.46 Function wizard

Base box shows the cell address which contain base value.

**Step 10:** Directly type the cell address which contains exponent, in Exponent box; or repeat steps 7, 8 and 9.



After entering Base and Exponent cell references, the function wizard appears as shown in Figure 7.47

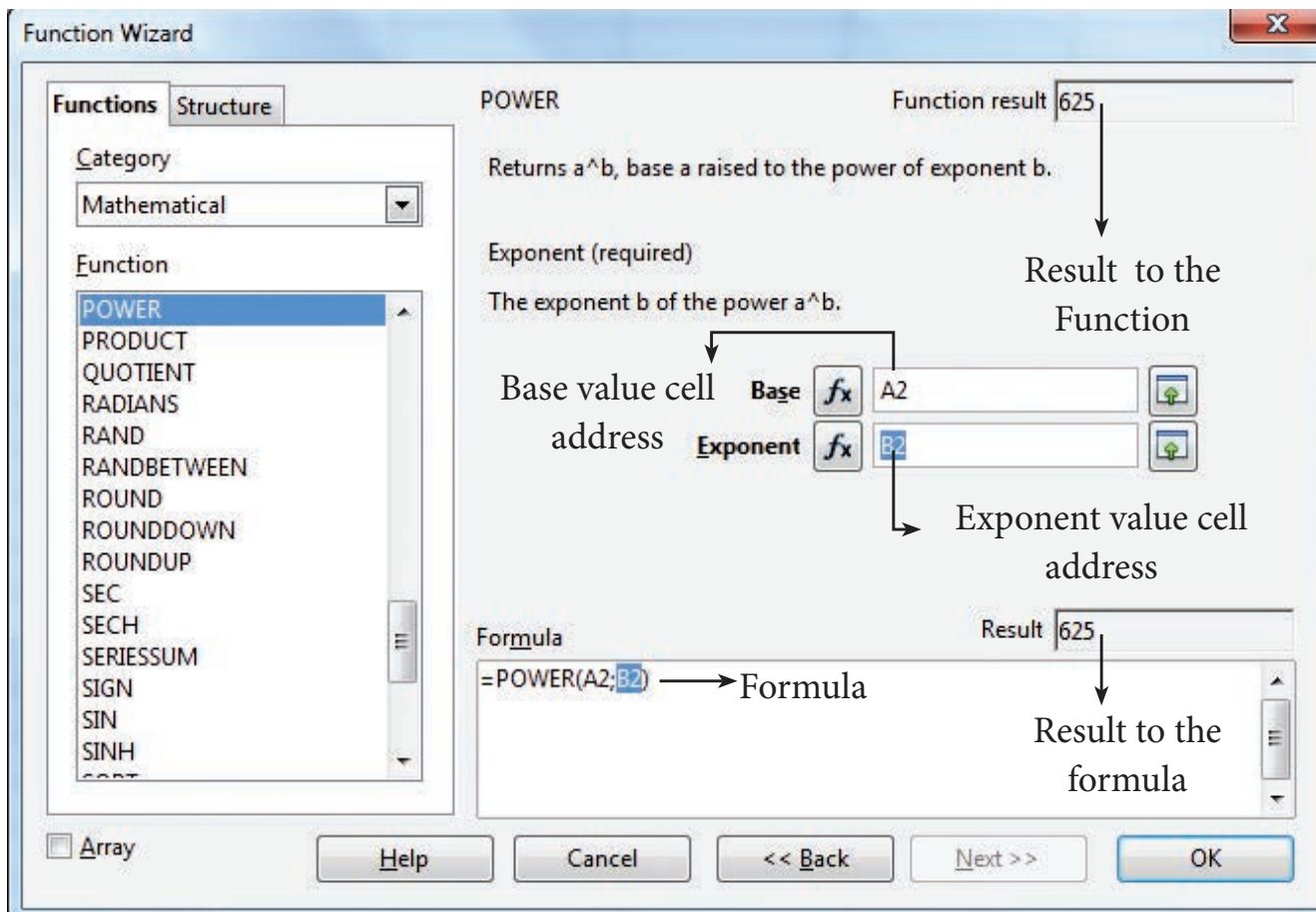

Figure 7.47 Function wizard

The formula box displays the syntax of the function with input values and Result box displays the result value.

Step 11: If the result is correct, click “OK” button else click “Back” button to display the previous page of this wizard.

#### Inserting a function using Function Wizard: (with direct values)

In the previous example, Cell addresses are used for Base and Exponent values. In Calc, direct values can be used instead of using cell reference (i.e. cell address) to find the same result.

In this case, type base and exponent value instead of cell address. Function wizard displays the result in the current cell. Refer Figure 7.48 shown below.

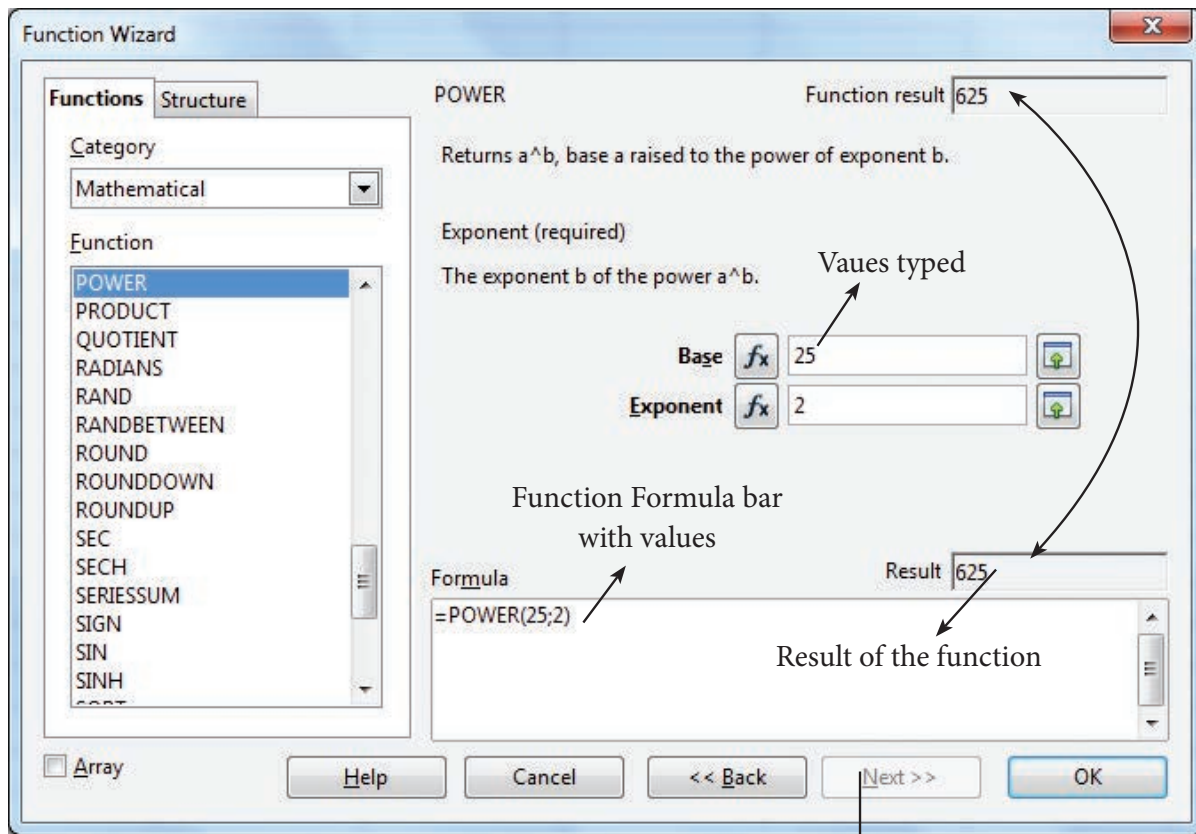

Figure 7.48 Function Wizard (with Direct values)

### Self Practice:

1. Open a new worksheet.
2. In cell A1 type as "Value"
3. In cell A2 type as "Square root"
4. In cell B1 type any value
5. In cell B2 insert the function to find the square root of the value in B1
6. After getting square root, change the value in B1, observe changes in result.
7. Use the same function in another sheet directly i.e. without using function wizard.

## 7.13 Working with Chart

### 7.13 Working with Chart

One of the most important features of spreadsheet is the ability to create charts based on numeric data. The charts are used to present data in an easy manner. Creating charts is the key factor for the of success of spreadsheet. OpenOffice Calc provides a "chart wizard" to create and manipulate charts.

### 7.13.1 Chart Wizard

Chart wizard is used to insert charts in Calc. Chart wizard can be invoked by clicking “chart” icon from standard toolbar or choosing Insert → Chart command. A "Chart wizard" appear as shown in Figure 7.49

Chart wizard dialog box has 4 steps viz. (1) Chart type (2) Data Range (3) Data Series and (4) Chart Elements. The “Next” button is used to move from one step to another step.

#### Step 1: Chart type

The first step of “Chart wizard” is used to select Chart type. All available chart types are listed under the “Choose a chart type” list box. On the right side of the list box shows style of the selected chart; each chart type has different styles.

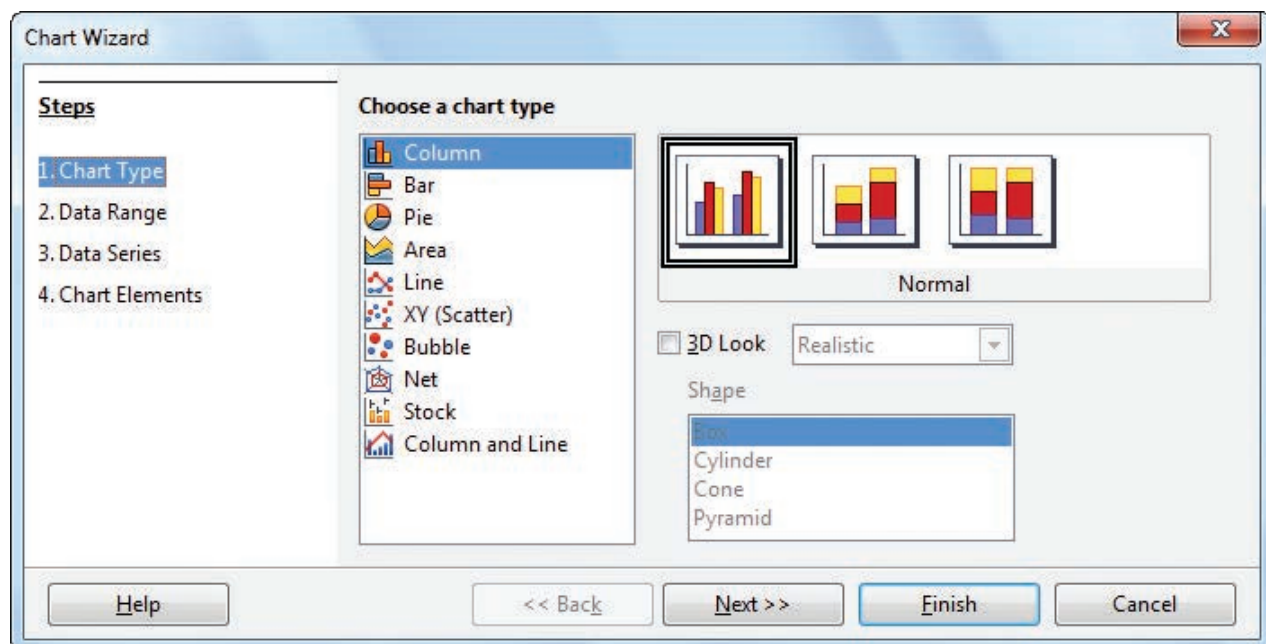

Figure 7.49 Chart Wizard – Step 1: Chart type

For example, Column chart has three styles viz. Normal, Stacked and Percent Stacked. Refer Figure 7.49

"3D Look" check box helps to display the selected chart type in an attractive form. 3D Look is applied only for Column, Bar, Pie and Area chart type. Refer Figure 7.50

Click, “Next” button to move to the second step.

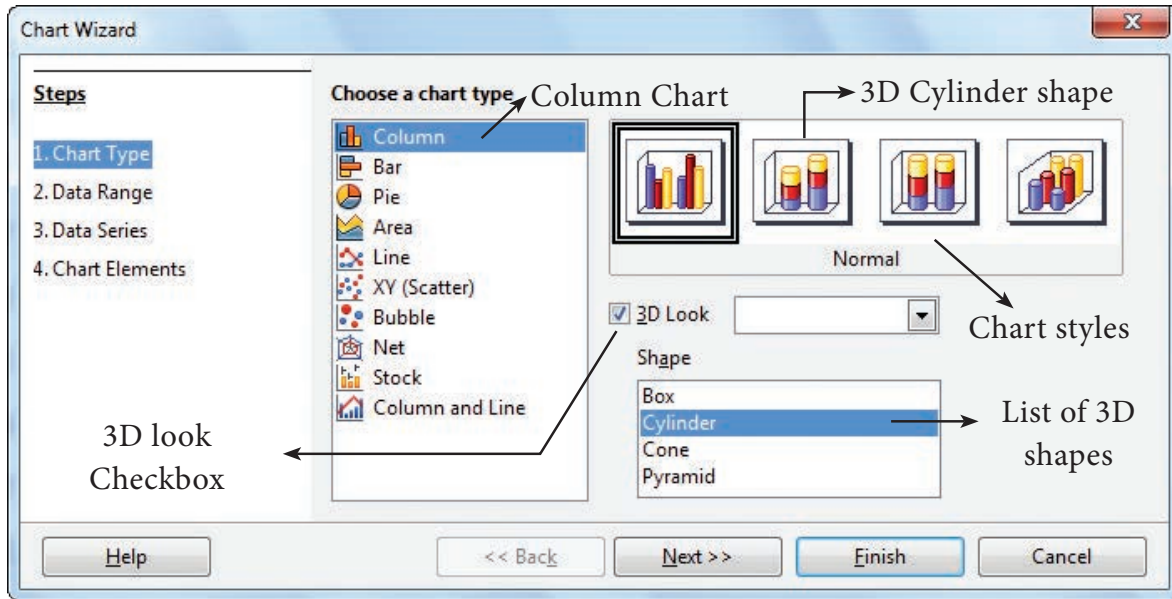

Figure 7.50 Chart Wizard – Step 1: Chart type with 3D Look

## Step 2: Data Range

In this step, specify the range of data for which the chart should be created in “Data range” text box or click “Select data range” button which is at the end of the textbox to minimize the wizard.

If the user had selected the data before invoking "chart wizard", the selected range will appear automatically in the textbox as shown in Figure 7.51.

There are two checkboxes used to set the first row or first column or both, as X and Y axis labels to the chart.

Click "Next" button to move to the third step.

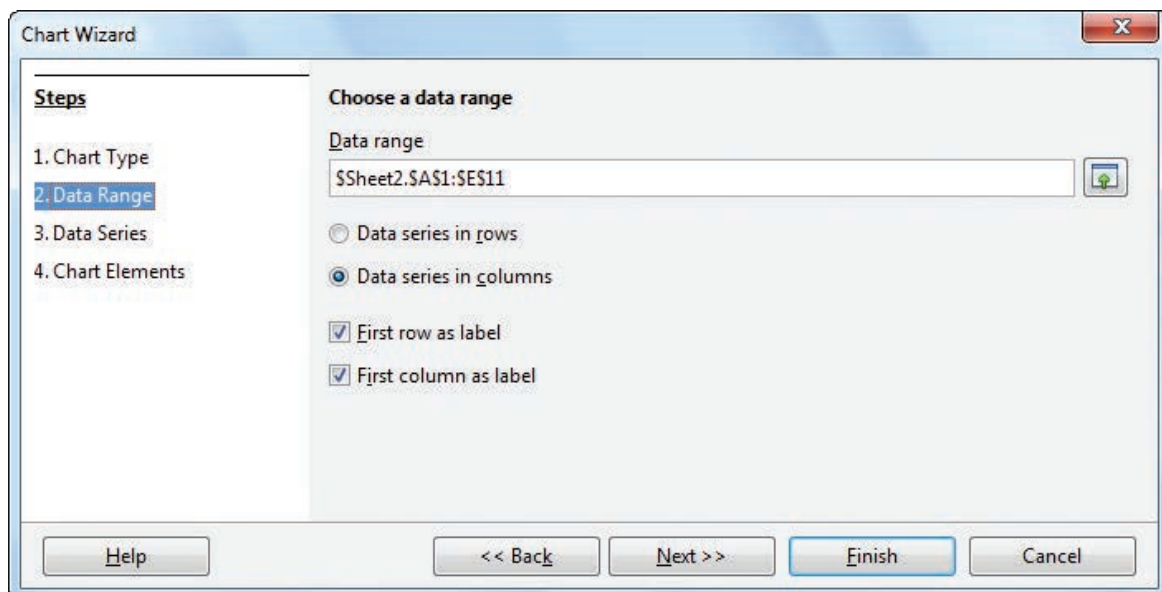

Figure 7.51 Chart Wizard – Step 2: Data Range

### Step 3: Data Series

In this step, the user can fine tune the data to be included in the chart. If you don't want to include any column, click the column names listed in "Data Series" box and click on "Remove" button or if you want to add some more columns click "Add" button. Refer Figure 7.52. This is useful only if you have very specific requirements for data in your chart. Otherwise simply click "Next" button to move the last step.

### Step 4: Chart Element

This step is used to insert or change titles and legend. In "Title" box, type the title for the chart, to add a subtitle type it in the "Subtitle" box. Refer Figure 7.53. For example, A chart for showing the highest mark holder in you class, you may enter as "Highest Mark holder" as title and "Class XII F" as subtitle.

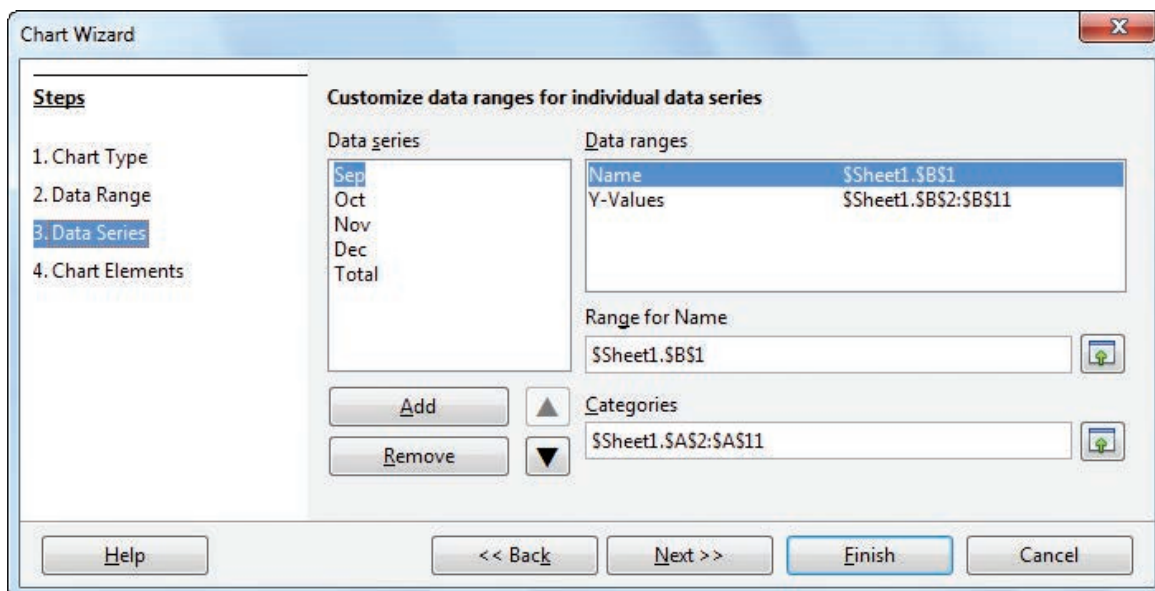

Figure 7.52 Chart Wizard – Step 3: Data Series

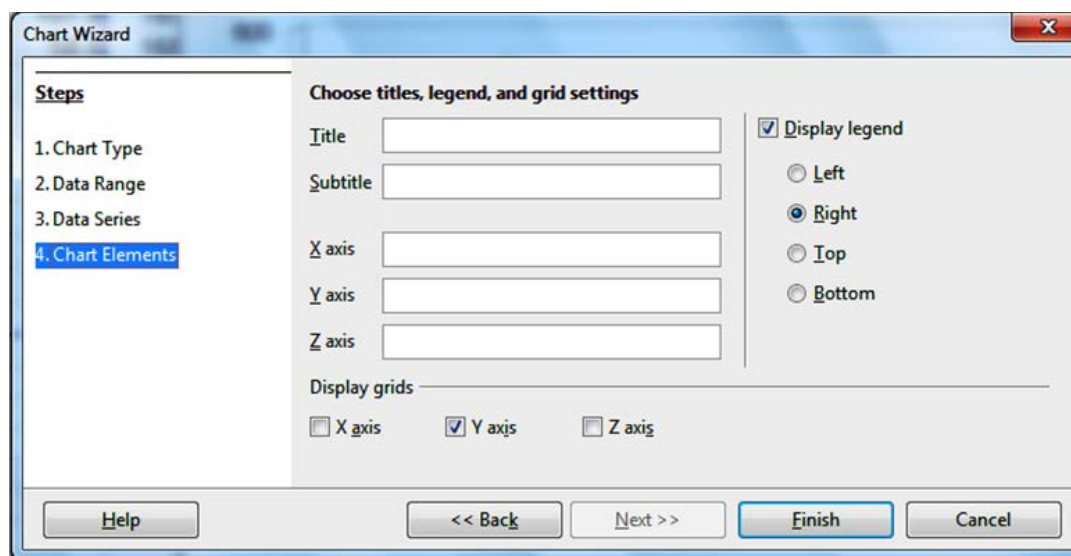

Figure 7.53 Chart Wizard – Step 3: Chart Elements

User can add or modify the labels of X and Y axis.

To create a chart click “Finish” button.

### 7.13.2 Demo for creating a chart

Type the following data in a new worksheet as in Figure 7.54. The following steps is followed to create a chart for the given data.

#### Step 1 – Select Data:

- Select the data from A1 to F11.

#### Step 2 – To open the chart wizard:

- Click “Chart” icon from Standard toolbar (or) choose Insert → Chart.

#### Step 3 – Selecting Chart type and shape: (Refer Figure 7.55)

	A	B	C	D	E	F	G
1	<b>District</b>	<b>Sep</b>	<b>Oct</b>	<b>Nov</b>	<b>Dec</b>	<b>Total</b>	
2	Chennai	107.5	165.6	224.2	263.7	761	
3	Coimbatore	58.6	168.7	234.2	34.1	495.6	
4	Cuddalore	108.2	145.4	553.3	345	1151.9	
5	Dharmapuri	71.8	108.8	299.2	27.7	507.5	
6	Erode	92.7	113.3	343.1	39	588.1	
7	Kanchipuram	116.1	192	291.9	260.9	860.9	
8	Madurai	153.8	220.3	395.2	140.5	909.8	
9	Theni	95.7	167.7	296.5	48.2	608.1	
10	Tirunelveli	84.6	111.9	291.7	152.2	640.4	
11	Tiruvallur	155.8	133.1	207.2	177.9	674	
12							
13							

Figure 7.54 Rainfall (in mm) data of ten districts in 2010

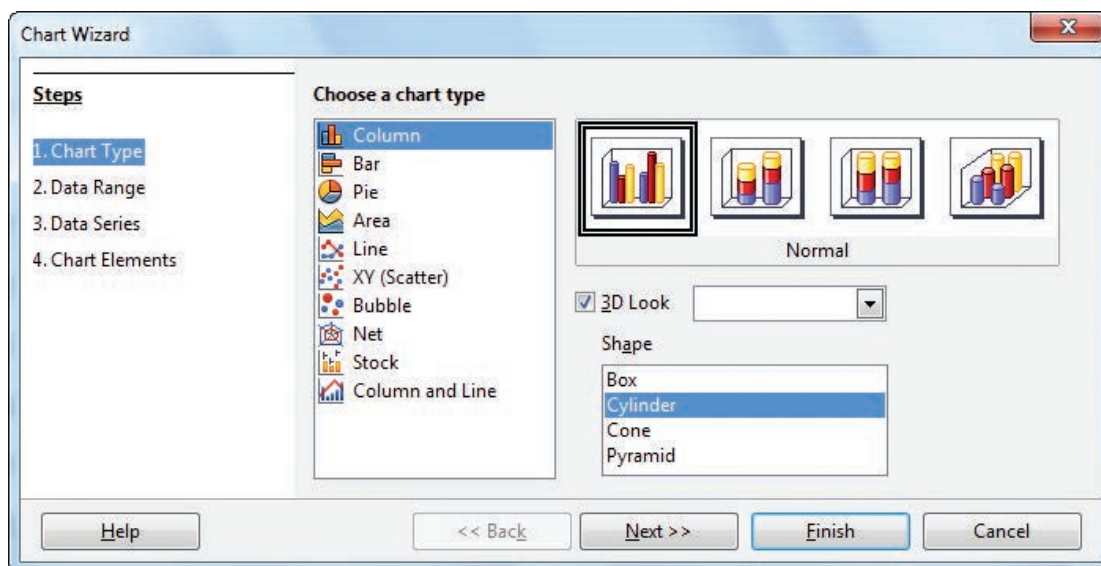

Figure 7.55 Chart Wizard – Step 1 Chart Type

- Select “Chart type” as Column and style as Normal
- Check “3D Look” and click “Cylinder shape”
- Click “Next” button.
- If the user wants change any other type or shape, click on the style image. Preview of the chart displayed on the backgroup of the chart wizard. So, you can view the chart at every stage of design.

#### Step 4 – Defining Data range: (Refer Figure 7.56)

- In this case, the data has been selected earlier. So, the selected data range is displayed in the “Data range” box.
- Other settings are by default. Click “Next” to move to step 5.

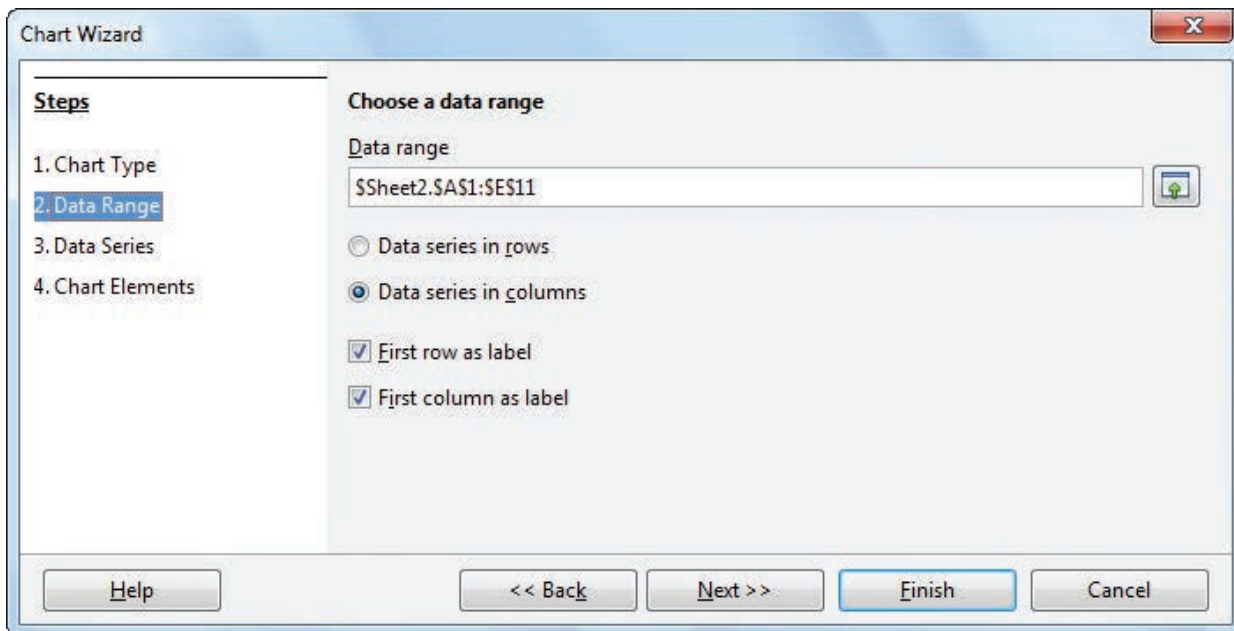

Figure 7.56 Chart Wizard – Step 2 Data Range

#### Step 5 – Adding or Removing Data series: (Refer Figure 7.57)

- “Data Series” list box shows all the columns to be included in the chart.
- Click on the “Total” in the data series box and click “Remove” button to remove the column.
- If you don’t want to add or remove anyother column click “Next” button to move to the last step.

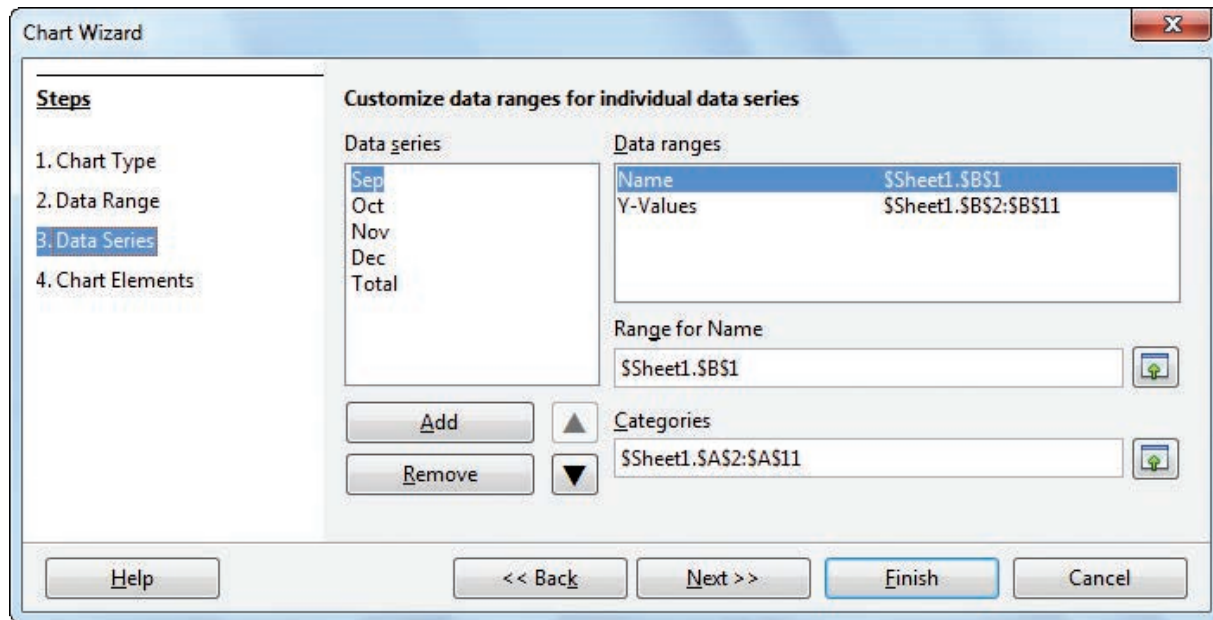

Figure 7.57 Chart Wizard – Step 3 Data Series

#### Step 6 – Adding Title, Subtitle, Name of X and Y axis: (Refer Figure 7.58)

- Type the title and subtitle of the chart in “Title” and “Subtitle” box
- Type the name of the X and Y-axis in the respective boxes.
- The Display legend text box is selected to the right which is the default.
- Click “Finish” button.

Now the chart will be displayed as in Figure 7.59.

#### 7.13.3 Editing Chart elements:

After inserting a chart any element of the chart can be modified. To modify the element

- Double click on the element
- Right click on the selected element
- Select Format from the popup menu.

For example, To change the display pattern of the X-axis, double-click on the X-axis and then right-click on it. A pop-up menu appears as shown in the Figure 7.60.

- In this popup menu, click “Format Axis...” option.



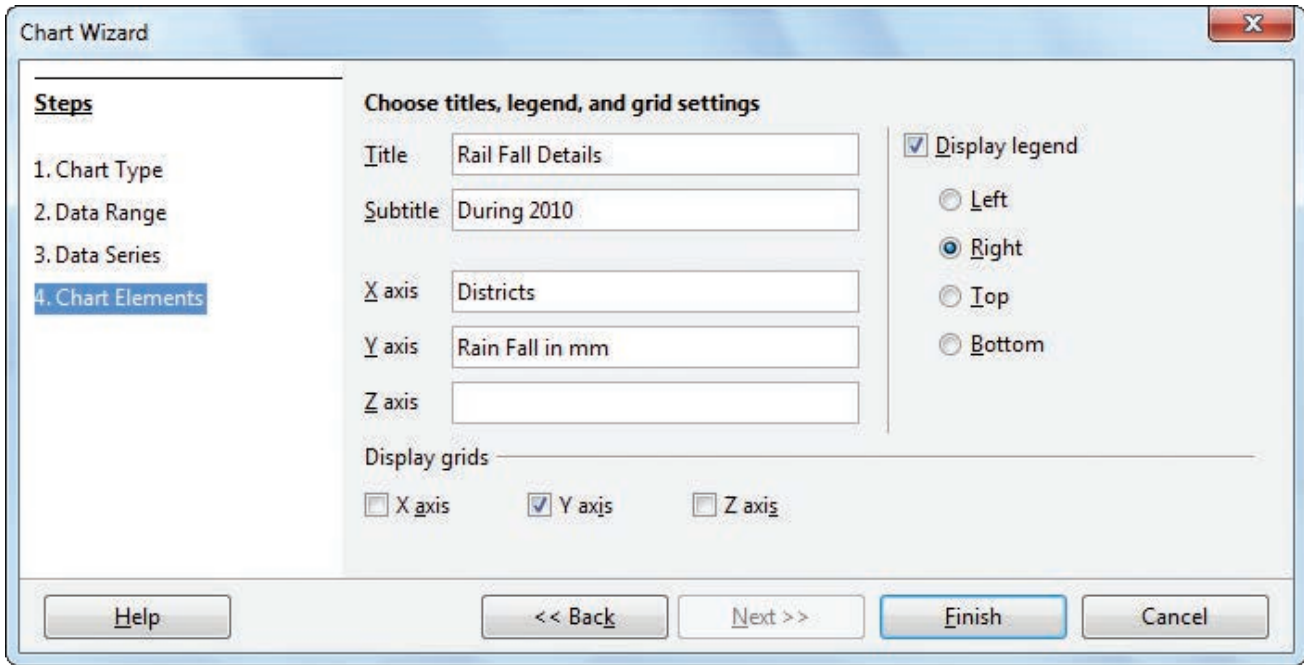

Figure 7.58 Chart Wizard – Step 4 Chart Elements

Now the chart will be displayed as given below

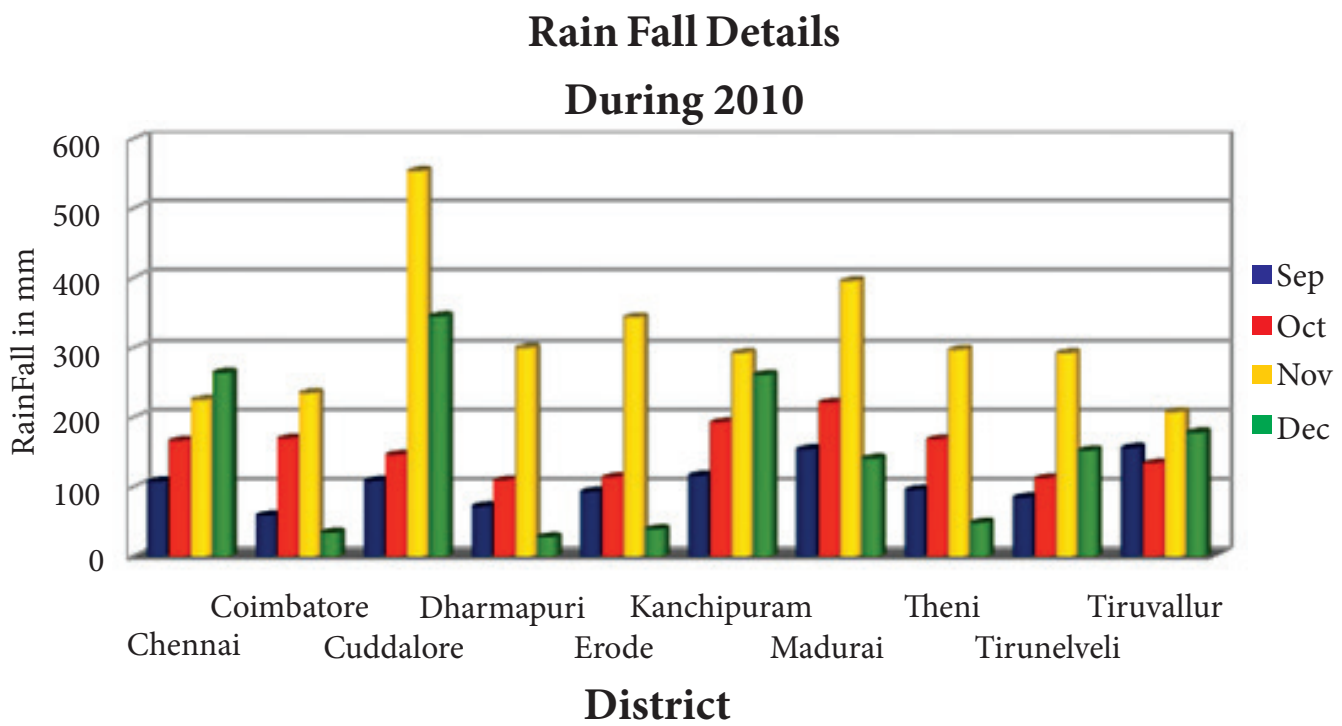

Figure 7.59 Chart

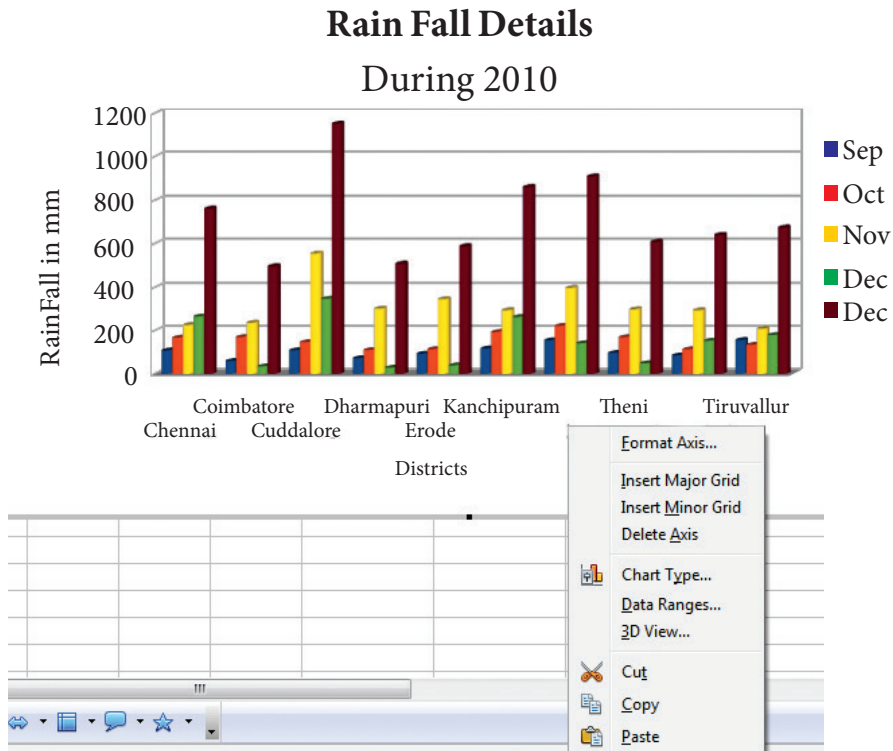

Figure 7.60 Chart element formatting pop-up menu

- Now, a Format Axis dialog box appears as shown in Figure 7.61

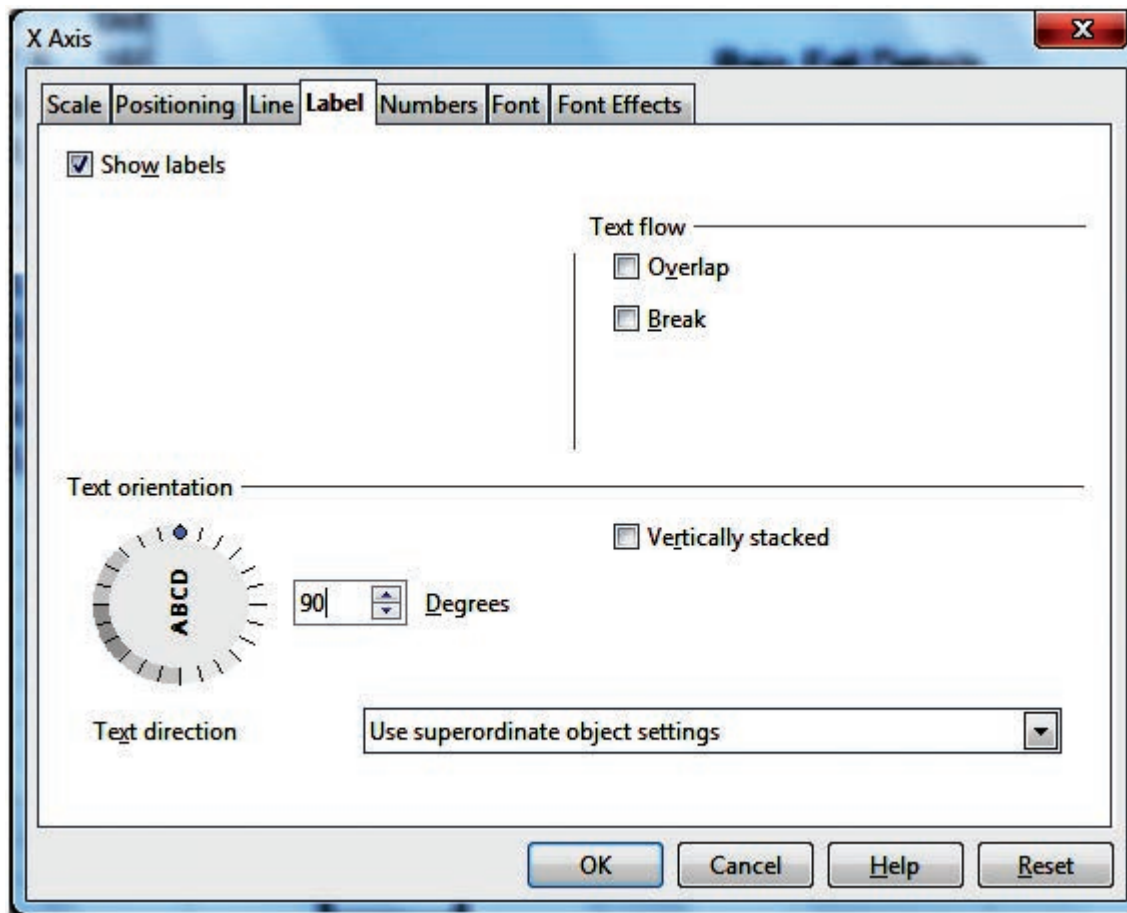

Figure 7.61 Chart Element Properties dialog box

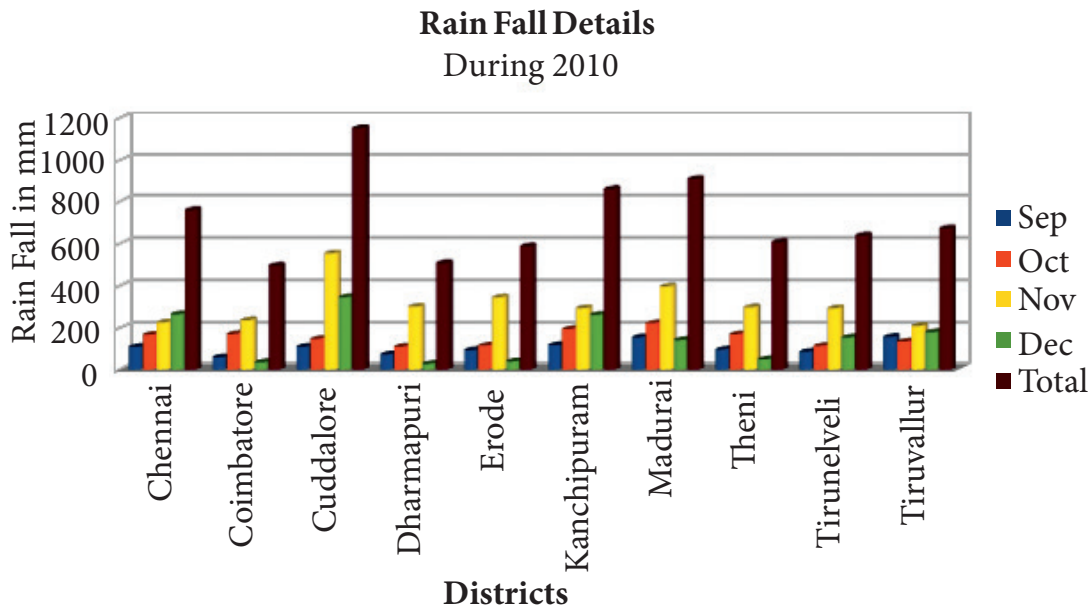

Figure 7.62 Completed Chart

Select “Label” tab.

- In Text Orientation spinbox, type as 90 degree or click and drag the Text direction animated handle.
- Click “OK” button.
- Now, the chart will be as in Figure 7.62

### Self Practice:



1. Open the spreadsheet which was created in Illustration 1.
2. Create a column chart with 3D “cone” shape showing the total marks of all students.

## Part – IV Sorting Filtering and Page setup

### 7.14 Advanced data analysis tools

A spreadsheet is a “Flat file database”. Thus, database operations such as sorting, filtering can be done on spreadsheet. The “Data” menu of OpenOffice calc provides maximum data analysis tools such as sorting, filtering, validity etc., In this part, the sorting and filtering feature is to be learnt.

#### 7.14.1 Database

A database is a repository of collections of related data or facts. It arranges them in a specific structure. The table given below contains details of students in a class.

Sl. No	Class	Group Code	Student Name	Gender	Comm Date of Birth	Date of Birth	Religion
1	XII - F1	302	GANDHIMATHI N	F	SC	02/10/2000	H
2	XII - H2	402	SANDHIYA D	F	SC	19/08/2000	H
3	XII - H2	402	SUMATHI P	F	BC	06/09/1999	H
4	XII - F1	302	JAYASREE J	F	BC	09/06/2001	H
5	XII - H1	402	JOTHIKA A	F	SC	07/04/2001	H
6	XII - H2	402	RAMYA T	F	MBC	23/11/2000	H
7	XII - F1	302	KOWSALYA T	F	SC	14/12/2000	H
8	XII - F1	302	ASHA A P	F	SCA	14/09/2000	H
9	XII - A	102	VENNILA T P	F	BC	14/02/2000	H
10	XII - F2	302	SANGEETHA G	F	MBC	14/01/2000	H

Table 7.14.1 Student Database

The entire collection or related data in one table is referred to as a File or a Table. Each row in a table represents a Record, which is a set of data for each database entry. Each table column represents a Field, which groups each piece or item of data among the records into specific categories. (Refer Figure 7.63)

#### 7.14.2 Sorting:

Sorting is the process of arranging data in ascending or descending order. There are two types of sorting in OpenOffice Calc. They are,

- (1) Simple Sorting
- (2) Multi Sorting
- (3) Sort by selection

### (1) Simple Sorting

Arranging data using single column is known as simple sorting. For sorting the data, calc provide two icons on the standard tool bar viz. (1) Sort Ascending (2) Sort Descending.

- Sort Ascending – Arrange data in alphabetical order (A to Z / Small to Large)
- Sort Descending – Arrange data in reverse order (Z to A / Large to Small)

	A	B	C	D	E	F	G	H
1	SI No	Class	Group Code	Student Name	Gender	Comm	Date of Birth	Religion
2	1	XII - F1	302	GANDHIMATHI N	F	SC	02/10/2000	H
3	2	XII - H2	402	SANDHIYA D	F	SC	19/08/2000	H
4	3	XII - H2	402	SUMATHI P	F	BC	06/09/1999	H
5	4	XII - F1	302	JAYASREE J	F	BC	09/06/2001	H
6	5	XII - H1	402	JOTHIKA A	F	SC	07/04/2001	H
7	6	XII - H2	402	RAMYA T	F	MBC	23/11/2000	H
8	7	XII - F1	302	KOWSALYA T	F	SC	14/12/2000	H
9	8	XII - F1	302	ASHA A P	F	SCA	14/09/2000	H
10	9	XII - A	102	VENNILA T P	F	BC	14/02/2000	H
11	10	XII - F2	302	SANGEETHA G	F	MBC	14/01/2000	H
12	11	XII - H1	402	BHAVANI K	F	OC	25/11/2000	H
13	12	XII - F1	302	GAJA LAKSHMI S	F	MBC	18/02/2000	H
14	13	XII - H2	402	SAKTHIPRIYA E	F	SC	03/01/2000	H
15	14	XII - H2	402	SANDHIYA SRI M	F	SC	08/04/2001	H
16	15	XII - F1	302	ALFIYA BEE R	F	BCM	29/07/2000	M
17	16	XII - F2	302	VIGNESHWARI P	F	SC	20/07/2000	H
18	17	XII - F2	302	PRIYA W	F	SC	07/03/2000	H
19	18	XII - F1	302	ANJALI S	F	BC	21/02/2000	H
20	19	XII - H2	402	PAVITHRA S	F	SC	28/12/2000	H
21	20	XII - F1	302	KAMALESHWARI V	F	BC	16/02/2000	H

Field

Record

Figure 7.63 Spreadsheet Data Table

### Sorting data

**Step 1:** Place cell pointer in the field (column) to be sorted

**Step 2:** Click Sort Ascending or Sort Descending icon

OpenOffice Calc, sort the data of selected column and its corresponding values present in other columns are also arranged simultaneously. Refer Figure 7.65

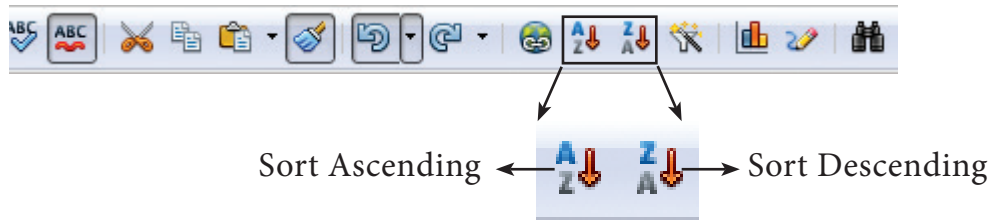

Figure 7.64 Standard Tool Bar with Sort Ascending / Descending

Click "Sort Ascending" icon to arrange ascending order ←

	A	B	C	D	E	F	G	H
1	SL No	Class	Group Code	Student Name	Gender	Comm	Date of Birth	Religion
2	1	XII - F1	302	GANDHIMATHI N	F	SC	02/10/2000	H
3	2	XII - H2	402	SANDHIYA D	F	SC	19/08/2000	H
4	3	XII - H2	402	SUMATHI P	F	BC	06/09/1999	H
5	4	XII - F1	302	JAYASREE J	F	BC	09/06/2001	H
6	5	XII - H1	402	JOTHIKA A	F	SC	07/04/2001	H
7	6	XII - H2	402	RAMYA T	F	MBC	23/11/2000	H
8	7	XII - F1	302	KOWSALYA T	F	SC	14/12/2000	H
9	8	XII - F1	302	ASHA A P	F	SCA	14/09/2000	H
10	9	XII - A	102	VENNILA T P	F	BC	14/02/2000	H
11	10	XII - F2	302	SANGEETHA G	F	MBC	14/01/2000	H
12	11	XII - H1	402	BHAVANI K	F	OC	25/11/2000	H
13	12	XII - F1	302	GAJA LAKSHMI S	F	MBC	18/02/2000	H
14	13	XII - H2	402	SAKTHIPRIYA E	F	SC	03/01/2000	H
15	14	XII - H2	402	SANDHIYA SRI M	F	SC	08/04/2001	H
16	15	XII - F1	302	ALFIYA BEE R	F	BCM	29/07/2000	M
17	16	XII - F2	302	VIGNESHWARI P	F	SC	20/07/2000	H
18	17	XII - F2	302	PRIYA W	F	SC	07/03/2000	H
19	18	XII - F1	302	ANJALI S	F	BC	21/02/2000	H

Figure 7.65 Sort Ascending

## (2) Multi Sorting

Sorting data based on more than one field (column) is known as **multi sorting**. For example, the worksheet containing data of 20 students belongs to different groups and classes. To rearrange this data alphabetically by name and group code, multi sorting is used. Refer Figure 7.66.

## Multi-sorting data

### Step 1: Select Data → Sort

	A	B	C	D	E	F	G	H
1	Sl. No	Class	Group Code	Student Name	Gender	Comm	Date of Birth	Religion
2	15	XII - F1	302	ALFIYA BEE R	F	BCM	29/07/2000	M
3	18	XII - F1	302	ANJALI S	F	BC	21/02/2000	H
4	8	XII - F1	302	ASHA A P	F	SCA	14/09/2000	H
5	11	XII - H1	402	BHAVANI K	F	OC	25/11/2000	H
6	12	XII - F1	302	GAJA LAKSHMI S	F	MBC	18/02/2000	H
7	1	XII - F1	302	GANDHIMATHI N	F	SC	02/10/2000	H
8	4	XII - F1	302	JAYASREE J	F	BC	09/06/2001	H
9	5	XII - H1	402	JOTHIKA A	F	SC	07/04/2001	H
10	20	XII - F1	302	KAMALESHWARI V	F	BC	16/02/2000	H
11	7	XII - F1	302	KOWSALYA T	F	SC	14/12/2000	H
12	19	XII - H2	402	PAVITHRA S	F	SC	28/12/2000	H
13	17	XII - F2	302	PRIYA W	F	SC	07/03/2000	H
14	6	XII - H2	402	RAMYA T	F	MBC	23/11/2000	H
15	13	XII - H2	402	SAKTHIPRIYA E	F	SC	03/01/2000	H
16	2	XII - H2	402	SANDHIYA D	F	SC	19/08/2000	H
17	14	XII - H2	402	SANDHIYA SRI M	F	SC	08/04/2001	H
18	10	XII - F2	302	SANGEETHA G	F	MBC	14/01/2000	H
19	3	XII - H2	402	SUMATHI P	F	BC	06/09/1999	H
20	9	XII - A	102	VENNILA T P	F	BC	14/02/2000	H
21	16	XII - F2	302	VIGNESHWARI P	F	SC	20/07/2000	H

Name are arranged in Ascending order According to names, other data also rearranged

**Step 2:** Sort dialog box appears. (Refer Figure 7.67)

**Step 3:** Select the field name (Student name) in which you want to sort from the “sort by” dropdown list box and then choose order of sorting i.e. Ascending or Descending. Ascending is the default selection.

**Step 4:** Select another field name (Group Code) from the “Then by” dropdown list box and choose the order of sorting to this column.

**Step 5:** Click “OK” button.

In OpenOffice Calc, multi sort can be done only for three fields.

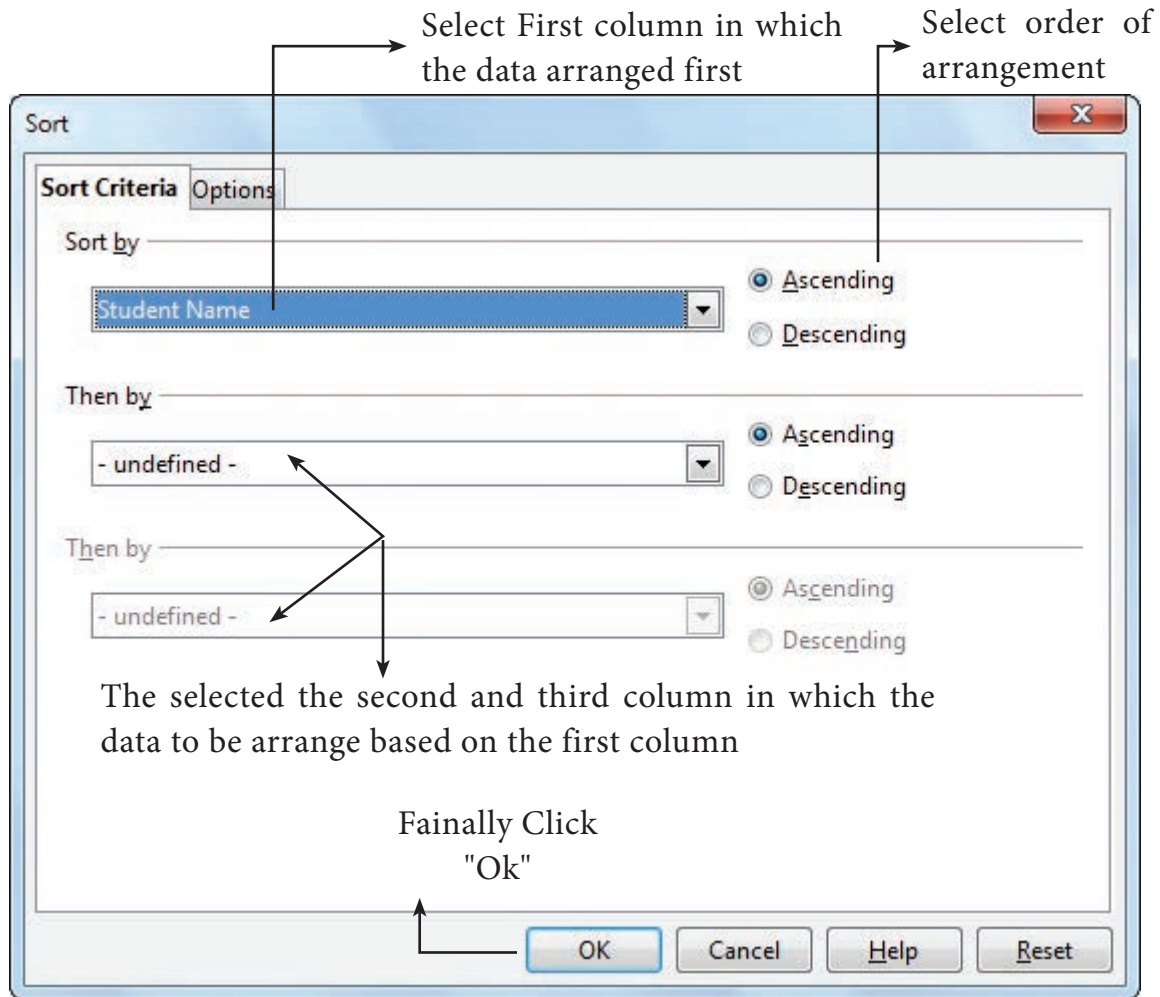

Figure 7.67 Multi-sorting dialog box

### (3) Sort by selection

In Calc sorting can be done on selected range. But this kind of sorting is generally not recommended, because the other relevant data are also not sorted. Therefore, OpenOffice Calc displays a warning message for this type of sorting. Refer Figure 7.68.

#### Sorting data by selection:

**Step 1:** Select any particular field in which you want sort.

**Step 2:** Click required Sort icon from standard tool bar or **Data** → **Sort command**.

Calc, display a “**Sort Range**” warning message as shown in the Figure 7.68

“Sort Range” message box has two options, viz. (1) Extend selection (2) Current selection.

**Step 3:** “Extend Selection” – Sort all the data based on the selection.

“Current Selection” – Sort only the selected range of data, remaining data are not sorted.



### 7.14.3 Filtering

Filter is a way of limiting the information that appears on screen. Filters

	A	B	C	D	E	F	G	H
1	SI No	Class	Group Code	Student Name	Gender	Comm	Date of Birth	Religion
2	1	XII - F1	302	GANDHIMATHI N	F	SC	02/10/2000	H
3	2	XII - H2	402	SANDHIYA D	F	SC	19/08/2000	H
4	3	XII - H2	402	SUMATHI P	F	BC	06/09/1999	H
5	4	XII -					6/2001	H
6	5	XII -					4/2001	H
7	6	XII -					1/2000	H
8	7	XII -					2/2000	H
9	8	XII -					9/2000	H
10	9	XII -					2/2000	H
11	10	XII -					1/2000	H
12	11	XII -					1/2000	H
13	12	XII -					2/2000	H
14	13	XII -					1/2000	H
15	14	XII -					4/2001	H
16	15	XII -					7/2000	M
17	16	XII - F2	302	VIGNESHWARI P	F	SC	20/07/2000	H
18	17	XII - F2	302	PRIYA W	F	SC	07/03/2000	H
19	18	XII - F1	302	ANJALI S	F	BC	21/02/2000	H

Figure 7.68 Sort by selection

are a feature for displaying and browsing a selected list or subset of data from a worksheet. The visible records satisfy the condition that the user sets. Those that do not satisfy the condition are only hidden, but not removed.

OpenOffice Calc allows three types of filters. They are *AutoFilter*, *Standard Filter* and *Advanced Filter*.

#### (1) Auto Filter:

Auto Filter applies a drop-down list box to each field (columns) filled with similar data available in that field. Using the list box item, you can filter the data that matches the criteria of the data concerned.

#### Using Auto Filter:

- Click Auto Filter icon available on the “Standard tools bar” (or) click **Data** → **Filter** → **Auto Filter**

- The list box contains similar data in the fields. Refer Figure 7.69 and 7.70
- Each list box item will be considered as filter criteria.

Drop down list box

	A	B	C	D	E	F	G	H
1	Sl No	Class	Group Code	Student Name	Gender	Comm	Date of Birth	Religion
2	1	XII - F1	302	GANDHIMATHI N	F	SC	02/10/2000	H
3	2	XII - H2	402	SANDHIYA D	F	SC	19/08/2000	H
4	3	XII - H2	402	SUMATHI P	F	BC	06/09/1999	H
5	4	XII - F1	302	JAYASREE J	F	BC	09/06/2001	H
6	5	XII - H1	402	JOTHIKA A	F	SC	07/04/2001	H
7	6	XII - H2	402	RAMYA T	F	MBC	23/11/2000	H
8	7	XII - F1	302	KOWSALYA T	F	SC	14/12/2000	H
9	8	XII - F1	302	ASHA A P	F	SCA	14/09/2000	H
10	9	XII - A	102	VENNILA T P	F	BC	14/02/2000	H

Figure 7.69 Spreadsheet table with Auto Filter

	A	B	C	D	E	F	G	H
1	Sl No	Class	Group Code	Student Name	Gender	Comm	Date of Birth	Religion
2	1	XII - F1	All	GANDHIMATHI N	F	SC	02/10/2000	H
3	2	XII - H2	Top 10	SANDHIYA D	F	SC	19/08/2000	H
4	3	XII - H2	Standard Filter...	SUMATHI P	F	BC	06/09/1999	H
5	4	XII - F1	102	JAYASREE J	F	BC	09/06/2001	H
6	5	XII - H1	302	JOTHIKA A	F	SC	07/04/2001	H
7	6	XII - H2	402	RAMYA T	F	MBC	23/11/2000	H
8	7	XII - F1		KOWSALYA T	F	SC	14/12/2000	H
9	8	XII - F1		ASHA A P	F	SCA	14/09/2000	H

Figure 7.70 Auto Filter dropdown list box

- Select the data item from the list box. Now, Calc shows only the records which are satisfy the selected criteria.

### Example:

If you want to apply an auto filter to the contents of the table 7.14.1, follow the following two steps

Step 1: Place cell pointer anywhere in the table

Step 2: Click Auto Filter icon available on the “Standard tools bar” (or) Click Data → Filter → Auto Filter

In the above table, if you want to view only the students belongs to the Group code 402;

- Click the dropdown list box’s drop arrow (a tiny triangle) to get the filter criteria. (Refer Figure 7.70)

- Select group code 402 from the list
- The spreadsheet displays only the student's details those who are studing in group code 402 (Refer Figure 7.71) and the remaining details are only hidden.

	A	B	C	D	E	F	G	H
1	Sl No	Class	Group Code	Student Name	Gender	Comm	Date of Birth	Religion
3	2	XII - H2	402	SANDHIYA D	F	SC	19/08/2000	H
4	3	XII - H2	402	SUMATHI P	F	BC	06/09/1999	H
6	5	XII - H1	402	JOTHIKA A	F	SC	07/04/2001	H
7	6	XII - H2	402	RAMYA T	F	MBC	23/11/2000	H
12	11	XII - H1	402	BHAVANI K	F	OC	25/11/2000	H
14	13	XII - H2	402	SAKTHIPRIYA E	F	SC	03/01/2000	H
15	14	XII - H2	402	SANDHIYA SRI M	F	SC	08/04/2001	H
20	19	XII - H2	402	PAVITHRA S	F	SC	28/12/2000	H

Figure 7.71 Filtered details

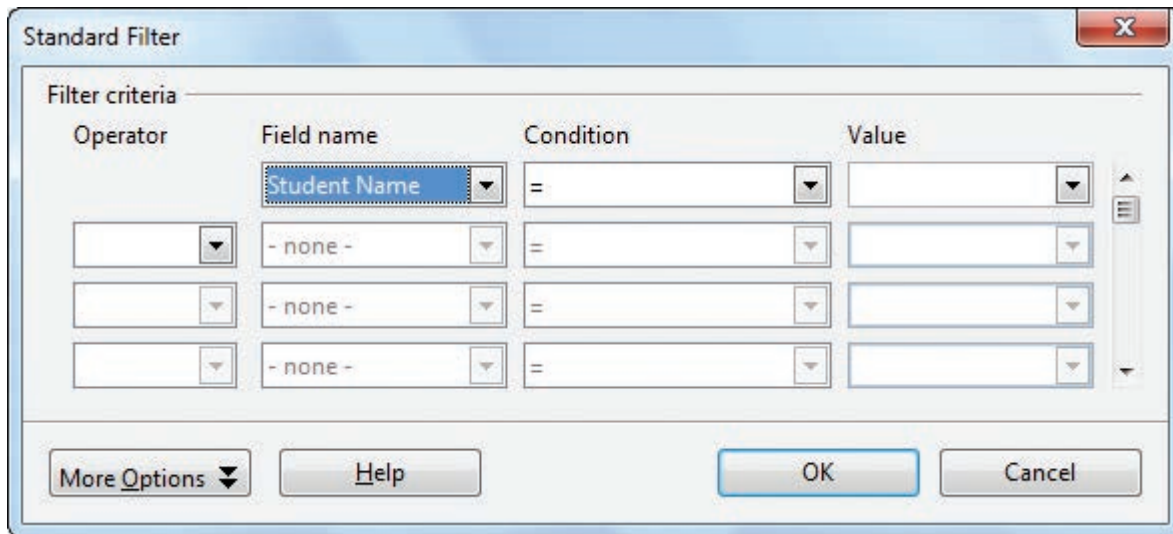

Figure 7.72 Standard Filter dialog box

### Removing Auto Filter:

- To remove auto filter, click “Auto filter” icon once again .
  - The original table is displayed without filter.
- (2) **Standard Filter:** Auto filter is used only for single criteria on a data, whereas the Standard filter is used for multiple criteria to filter.

### Step 1:

- Select Data → Filter → Standard Filter.

- Now, the entire data is selected and "Standard Filter" dialog box displays as shown in Figure 7.73.

**Step 2:**

- Select the column heading from the "Filed name" list box for first criteria.
- Select conditional operator such as >, <, = etc., from "Condition" list box.
- Type or select the value of criteria in the "Value" box.

**Step 3:**

- Select the one of the logical operator (And / Or) from "Operator" list box to fix second criteria.
- Follow the step 2, for the next criteria.

**Step 4:**

- Click "OK" to finish.

**Example for Standard filter:**

If you want to filter the records of "BC" students of group code 402 from the table

7.14.1

**Step 1:** Select Data → Filter → Standard Filter

- Now, "Standard Filter" dialog box appears as in Figure 7.73

**Step 2:** In "Standard Filter" dialog box, select the first criteria;

- Select Field name as Group code
- Select Condition as =
- Type or select Value as 402

**Step 3:** To select the second criteria;

- Select Operator as "AND"
- Select Field name as Class
- Select Condition as =
- Type or select Value as XII- H2

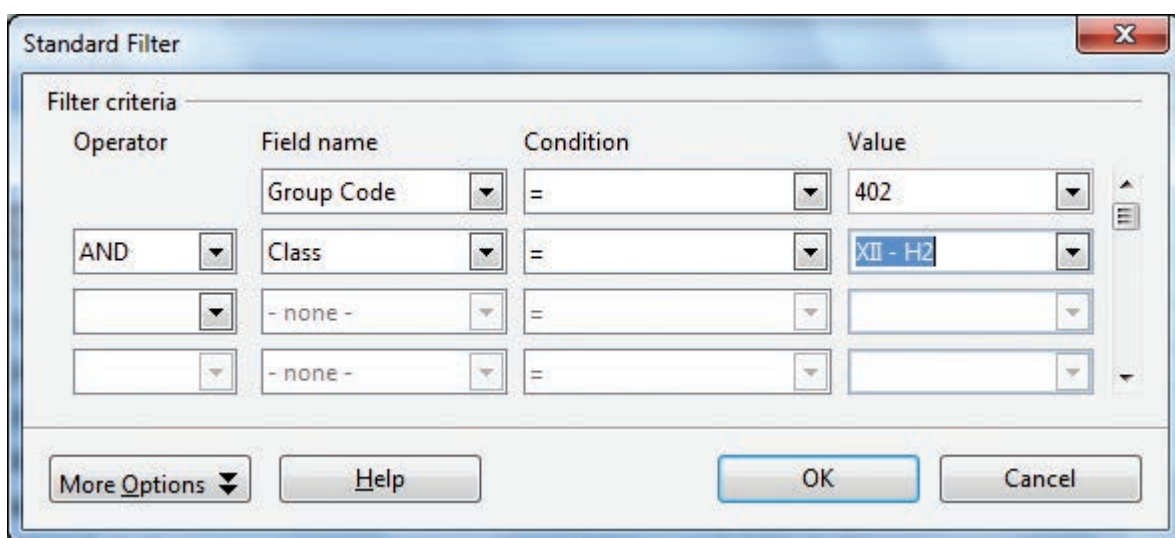

Figure 7.73 Standard Filter

**Step 4: Click “OK”**

- Now, the table displays only the records which are match for the given two criteria. Refer Figure 7.74.

**Remove Standard Filter:**

- Select Data → Filter → Remove Filter

	A	B	C	D	E	F	G	H
1	Sl No	Class	Group Code	Student Name	Gender	Comm	Date of Birth	Religion
3	2	XII - H2	402	SANDHIYA D	F	SC	19/08/2000	H
4	3	XII - H2	402	SUMATHI P	F	BC	06/09/1999	H
7	6	XII - H2	402	RAMYA T	F	MBC	23/11/2000	H
14	13	XII - H2	402	SAKTHIPRIYA E	F	SC	03/01/2000	H
15	14	XII - H2	402	SANDHIYA SRI M	F	SC	08/04/2001	H
20	19	XII - H2	402	PAVITHRA S	F	SC	28/12/2000	H
22								

Figure 7.74 Class XII student of group 402

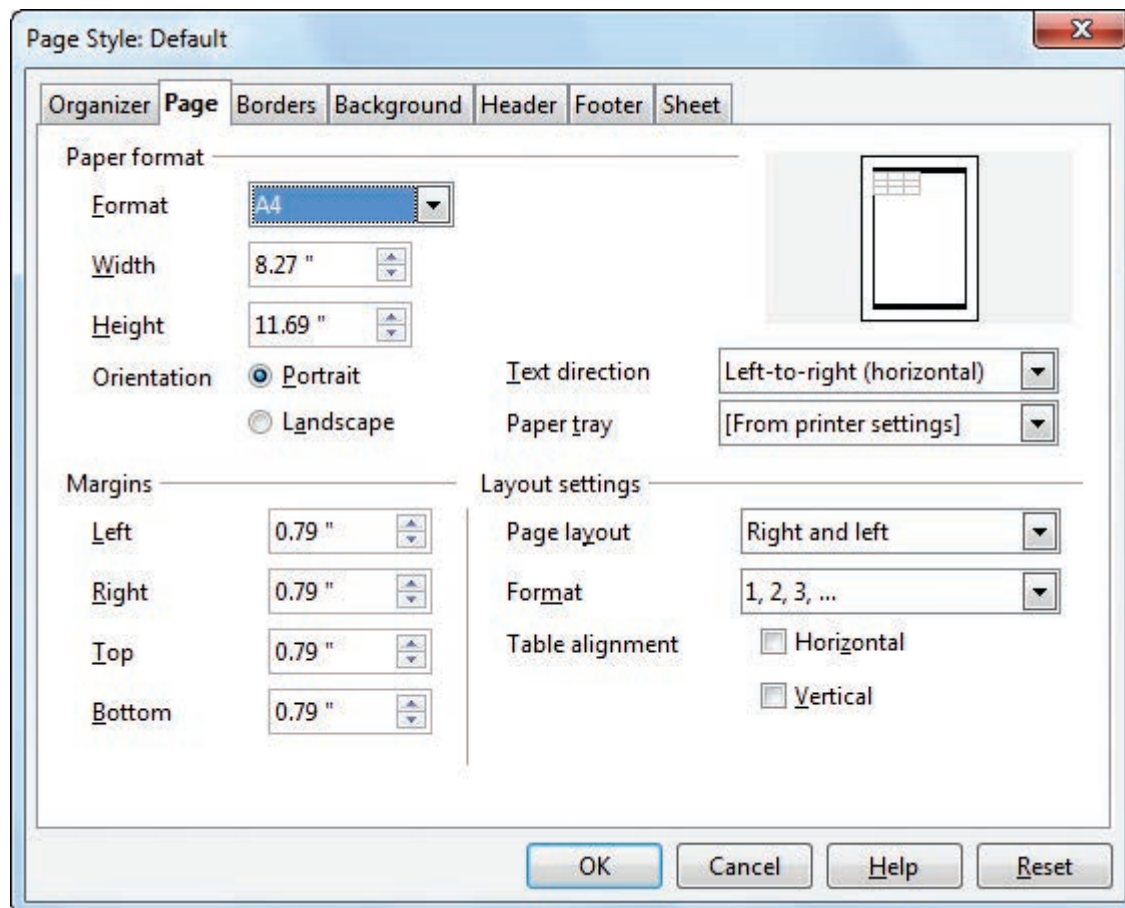

Figure 11.75 Page Style dialogue box

- “Header” tab is used to create header
- “Footer” tab is used to create footer

### 7.15 Setting the page size, Orientation and Margins

- To set page size, select Format → Page
- Page style dialoge box will appears as shown in figure 7.75.
- “Page” tab is used to change page size, orientation and margin
- “Header” tab is used to create header
- “Footer” tab is used to create footer

#### Workshop 1

1. Create a worksheet with following data

Emp. No	Name of Emp.	Basic	DA	HRA	CCA	MA	GPF	IT	HF
1001	Manivannan M	25500	25 % of Basic	%15 of Basic and DA	600	300	12 % of Basic	%10 of Gross	250
1002	Kannan K	20200			600	300			250
1003	Gowrishankar N V	24300			600	300			250
1004	Lenin K	23400			600	300			250
1005	Suryanarayanan T	24100			600	300			250
1006	Ramesh K	18500			600	300			250
1007	Govindasami A	13200			600	300			250
1008	Kannan S	20250			600	300			250
1009	Penchil Rao K	28300			600	300			250
1010	Logeswaran M	30200			600	300			250
1011	Arumugam E	12000			600	300			250
1012	Vasu G N	25000			600	300			250

Based on the above data,

- (1) Calculate the Gross Salary, Total Deductions and Net Salary
- (2) Insert “IT Cess” column and calculate 3% of cess to all employees

- (3) Delete the records of “Govindasami” and “Arumugam”.
- (4) Insert four new rows and enter the following employee details.
- (5) Calculate the Total amount of GPF, IT and Cess

Emp. No	Name of Emp.	Basic	DA	HRA	CCA	MA	GPF	IT	HF
2001	Murali G	24750							
2002	Munirathnam A	23550							
2003	Ramakrishnan V G	25500							
2004	Srinivasan R	27500							

### Workshop: 2

1. Create a new worksheet in OpenOffice Calc.
2. Enter the following stock and sales details of “Chennai whole sale Marketing Pvt. Ltd.” during the month of Jan-2018.

Code	Product Name	Weight (gm)	Opening stock	Cost price	Sales in units	Rate of Discount	Amount of Discount	Selling price	Amount of Sale	Closing Stock
100	Marie Gold	120	345	15	147	5%				
101	Milk Bikis	85	106	10	63	5%				
102	Dark Fantasy	75	147	25	43	3%				
103	Nutri Choice	250	98	50	12	10%				
104	Lays potato chips	52	172	15	152	4%				
105	Oreo	120	112	25	85	6%				

3. Calculate the following using formula or function
  - (i) Amount of Discount, Selling price and Amount of sales for each product
  - (ii) Total amount of discount and Sales of the month
  - (iii) Closing stock of each product
4. Draw a Pie chart to show the highest selling product.

### Workshop: 3

1. Create a worksheet in OpenOffice Calc.
2. Enter the following details of loan sanctioned during the month of January 2018 of “Tamil Finance Corporation”.

AC No Emp. No	Name	Amount of Loan	Loan Sanction date	Duration of Loan	Rate of Interest	Interest (Rs)	Total Amount	Due date
2001	Senthil	250000	02/01/2018	120 days	9.5%			
2002	Kumar	175000	15/01/2018	150 days	9.5%			
2003	Ibrahim	550000	16/01/2018	140 days	10.5%			
2004	Valli	375000	21/01/2018	210 days	10%			
2005	Charles	450000	28/01/2018	130 days	10.5%			

3. Create the formula to calculate

(i) Interest, Total amount and due date.

(ii) Gross total of amount of loan, interest and total amount.

4. Insert 5 new rows between Kumar and Ibrahim and include the following details

AC No	Name	Amount of Loan	Loan Sanction date	Duration of Loan	Rate of Interest	Interest (Rs)	Total Amount	Due date
3001	Pari	250000	03/02/2018	125 days	9.5%	5%		
3002	Arul	375000	07/02/2018	155 days	9.5%	5%		
3003	Raman	350000	10/02/2018	130 days	10.5%	3%		
3004	Givind	450000	10/02/2018	100 days	10%	10%		
3005	Zeenath	800000	26/02/2018	90 days	10%	4%		



### Points to Remember:

- Spreadsheet is a very useful office automation tool for organization, analysis and storage of data in a tabular form.
- Daniel Bricklin and Bob Frankston developed the first spreadsheet software called “VisiCalc” in 1979 for Apple II.
- OpenOffice Calc is popular open source spreadsheet application software presently maintained by Apache Foundation.
- A worksheet is a grid of cells with a programmable calculator attached to each cell.
- OpenOffice Calc version 4.1.5 contains a total of 1024 columns and 10,48,576 rows.
- Intersection of every row and column makes a box which is called as “Cell”.
- Cell pointer is a rectangle element which can be moved around the worksheet.
- The cell in which the cell pointer is currently located is known as “Active cell”.
- All formula should start with an equal sign.
- There are four types operators supported by calc.
- The charts are used to present numerical data in an easy manner.

### Activity



#### Student Activity

1. Based on the concept of calculation using formula / functions, make the students to create various worksheet data.
2. Make the students prepare Charts and manipulate data using sorting and filtering features.

#### Teacher Activity

1. To show the demo of working with spread sheets using simple example in class room.

## Evaluation



### Part – I

#### Choose the correct answer

- Which is the first electronic spreadsheet?  
(A) Excel (B) Lotus 1-2-3  
(C) Visicalc (D) OpenOffice Calc
- Which of the following applications was the parent to OpenOffice Calc?  
(A) Visicalc (B) LibreCalc  
(C) Lotus 123 (D) StarOffice Calc
- Grid of cells with a programmable calculator:  
(A) Spreadsheet (B) Database  
(C) Word processor (D) Linux
- A column heading in Calc is represented using  
(A) Number (B) Symbol  
(C) Date (D) Alphabet
- Which key is used to move the cell pointer in the forward direction within the worksheet?  
(A) Enter (B) Tab  
(C) Shift + Tab (D) Delete
- A formula in calc may begin with  
(A) = (B) +  
(C) - (D) All the above
- What will be the result from the following formula (Assume A1=5, B2=2)?  $+ A1^B2$   
(A) 7 (B) 25  
(C) 10 (D) 52



8. What will be the result from the following expression (Assume H1=12, H2=12)? = H1<>H2
- (A) True                      (B) False
- (C) 24                         (D) 1212
9. Which of the following symbol is used to make a cell address as an absolute reference?
- (A) +                         (B) %
- (C) &                         (D) \$
10. Which of the following key combinations is used to increase the width of the current column?
- (A) Alt + Right arrow                      (B) Ctrl + Right arrow
- (C) Alt + Left arrow                         (D) Ctrl + Left arrow

### Part – II

#### Very Short Answers

1. What are the types of toolbars available in OpenOffice calc?
2. What is a Cell pointer?
3. Write about the text operator in OpenOffice Calc.
4. Write the general syntax of constructing a formula in Calc.
5. What are the keyboard shortcuts to cut, copy and paste?
6. Can you edit the contents of a cell? If yes, explain any one of the method of editing the cell content.
7. What are the options available in “Insert Cells” dialog box?
8. Match the following

A	B
(a) Cut, Copy and Paste	(1) Absolute Cell
(b) Cell pointer	(2) Status bar
(c) Selection Mode	(3) Standard Toolbar
(d) \$A5\$	(4) Active cell

9. Define the following (i) Text Operator (ii) Rows and Columns of spreadsheet

10. Differentiate between Copy -Paste and Cut-Paste

### Part-III

#### Short Answers

1. Write a short note on OpenOffice Calc.
2. Write about inserting columns and rows in Calc.
3. Differentiate Deleting data using Backspace and Delete
4. Write any three formatting options.
5. In cell A1=34 A2=65 A3=89 write the formula to find the average.

### Part-IV

#### Explain in Detail

1. Explain about changing the column width in Calc.
2. Write the steps to generate the following series. 5, 10, 20 ..... 2560
3. Read the following table

	A	B	C	D	E
1	Year	Chennai	Madurai	Tiruchi	Coimbatore
2	2012	1500	1250	1000	500
3	2013	1600	1000	950	350
4	2014	1900	1320	750	300
5	2015	1850	1415	820	200
6	2016	1950	1240	920	250

Above table shows the sales figures for “Air Cooler” sold in four major cities of Tamilnadu from the year 2012 to 2016. Based on this data, write the formula to calculate the following.

- (1) Total sales in the year 2015.
- (2) Total sales in Coimbatore from 2012 to 2016.
- (3) Total sales in Madurai and Tiruchi during 2015 and 2016.
- (4) Average sales in Chennai from 2012 to 2016
- (5) In 2016, how many “Air Coolers” are sold in Chennai compared to Coimbatore?

  
**GLOSSARY**

Spreadsheet	Sheet of paper that shows accounting or other data in rows and columns
What-if analysis	It is a process of changing the values in a cell to see how those changes will affect output.
VisiCalc	The first electronic spreadsheet application
GUI	Graphical User Interface
Excel	Familiar spreadsheet application developed by Microsoft Corporation.
Cell	Intersection of rows and column
Cell Pointer	A rectangular box, highlighting the cell in a spreadsheet.
Active cell	A cell in which the cell pointer is presently locating
Formula	A formula is an expression telling the computer what mathematical operation to perform upon a specific value.
Operator	A symbol that usually represents an action or process
Range	Group / Collection of cells
BODMAS Rule	Order of mathematical calculation: <b>B</b> rackets - <b>O</b> rders (powers or square roots) - <b>D</b> ivision - <b>M</b> ultiplication - <b>A</b> ddition - <b>S</b> ubtraction.
Drag fill handle	A small black box at the bottom right corner of the cell pointer.
Function	Predefined formula / A group of instructions to return a single result or a set of results.
Chart	Graphical representation of data.
Database	A large quantity of indexed digital information.
Flat file database	Single table, non relative database

**Annexure 2**

Sl. No	Function	Description	Syntax
1	Averageif	Averages the arguments that meet the condition	Average (range; criteria; average_range)
2	Celling	Rounds a number up to the nearest multiple of significance	Celling (number; significance; [mode])
3	Countif	Count the argument which meet the set conditions	Countif (range; criteria)
4	Fact	Calculates the factorial of a number.	Fact (number)
5	Floor	Rounds number down to the nearest multiple of significance	Floor (number1; number2)
6	Product	Multiplies the arguments	Product (number1; number2)
7	Quotient	Returns the integers portion of a division	Quotient (numerator; denominator)
8	Round	Rounds a number to a predefined accuracy	Round (number; count)
9	SQRT	Returns the square root of a number	SQRT (number)
10	Sum	Returns the sum of all arguments	Sum (number1; number2;...)
11	Sumif	Totals the arguments that meet the condition	Sumif (range; criteria; sum-range)
12	Sumsq	Returns the sum of the squares of the arguments	Sumsq (number1; number2;...)
13	DB	Returns the real depreciation of an asset for a specified period using the fixed-declining balance method	Db (cost; salvage; life; period;[month])
14	N	Converts a value to a number	N (value)
15	Date	Provides an internal for the date given	Date (year; month; day)

16	Days	Calculates the number of days between two dates	Days (date2; date1)
17	Days360	Calculate the number of days between two dates based on a 360 days year	Days360 (date1; date;[type])
18	Average	Returns the average of a sample	Average (number1; number2;...)
19	Count	Counts how many numbers are in the list of arguments	Count (value1; value2;...)
20	Concatenate	Combines several text items into one	Concatenate (text1; text2;..)
21	Len	Calculates length of a text string	Len (text)
22	Lower	Converts text to lower case	Lower (text)
23	Mid	Returns a partial text strings of a text	Mid (text; start; number)
24	Proper	Capitalizes the first letters in all words	Proper (text)
25	Upper	Converts text to upper case	Upper (text)

## Presentation Basics

### Learning Objectives

After learning this chapter, the students will be able to

- Know the open source presentation software
- explore opening a new presentation using Impress
- create a new presentation using various ways using Impress
- Know parts of the main Impress Window
- differentiate five sections of Task pane
- explain Window elements of Impress
- differentiate various views in Workspace
- explore drawing Objects & inserting OLE
- draw freeform shapes
- rotate Objects
- create animation in slides/objects



### 8.1 Presentation Software - Meaning

- A presentation software is a computer software package used to show information, in the form of a slide show.

**It includes three major functions:**

- an editor that allows the text to be inserted and formatted,
- a method for inserting and manipulating graphic images and
- a slide-show system to display the content.
- Presentation software is used to create presentations, quizzes, e-learning packages and multimedia products.
- Most presentation software packages will create your multimedia product using a series of slides.
- Text, images, video, animations, links and sound can be combined on each slide to create a final product.

The most commonly known presentation programs are OpenOffice.org Impress, Microsoft PowerPoint and Apple's Keynote. In this chapter, we are going to explore on OpenOffice.org's presentation Software Impress.



## 8.2. Impress

Impress is OpenOffice.org's presentations (slide show) module. You can create slides using Impress. It contains different elements like text, bulleted and numbered lists, tables, charts, clip art and a range of graphic objects. Impress has access to the spelling checker and thesaurus. Also, it comes with pre-packaged text styles, background styles with online help.

### 8.3. Opening a new presentation

You can start Impress in several ways:

- In order to open Impress using Start button, click Start button and select **All Programs** → **Open Office** → **OpenOffice Impress**. (Figure 8.1)
- If it is already pinned in the Start menu, just click and open it. (Figure 8.2)

### 8.4. Creating a new presentation

You can create a presentation by any one of the following methods.

1. By selecting an Empty presentation
2. By selecting From template

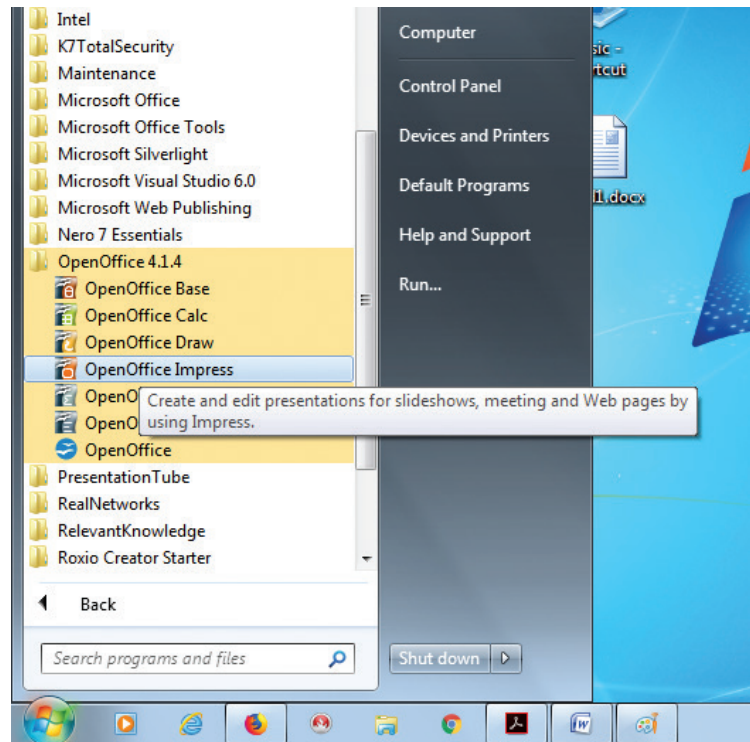

Figure 8.1 – Opening Impress using Start button (using All Programs)

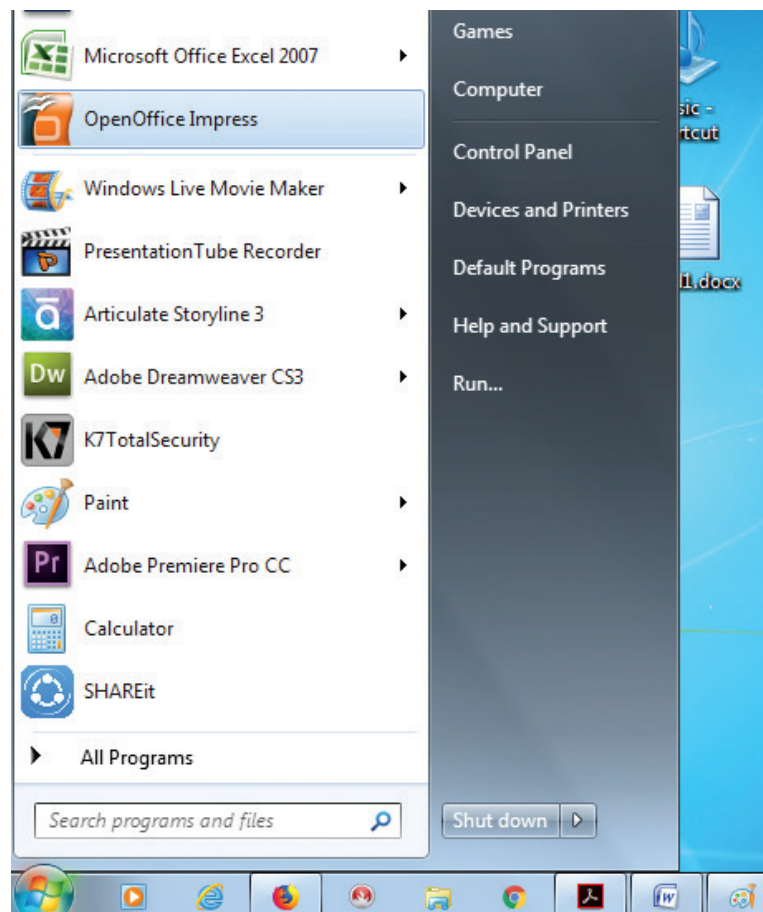

Figure 8.2 – Opening Impress using Start button

3. By selecting from Open existing presentation

#### 8.4.1. Using Empty presentation

1. Select Empty presentation under Type. It creates a presentation from scratch.
2. Click Next. The Presentation Wizard step 2 appears. Figure 8.4 shows the Wizard.

3. Choose a design under **Select a slide design**. The slide design section gives you two main choices: Presentation Backgrounds and Presentations.
4. Each one has a list of choices for slide designs. If you want to use one of these other than the <Original>, click it to

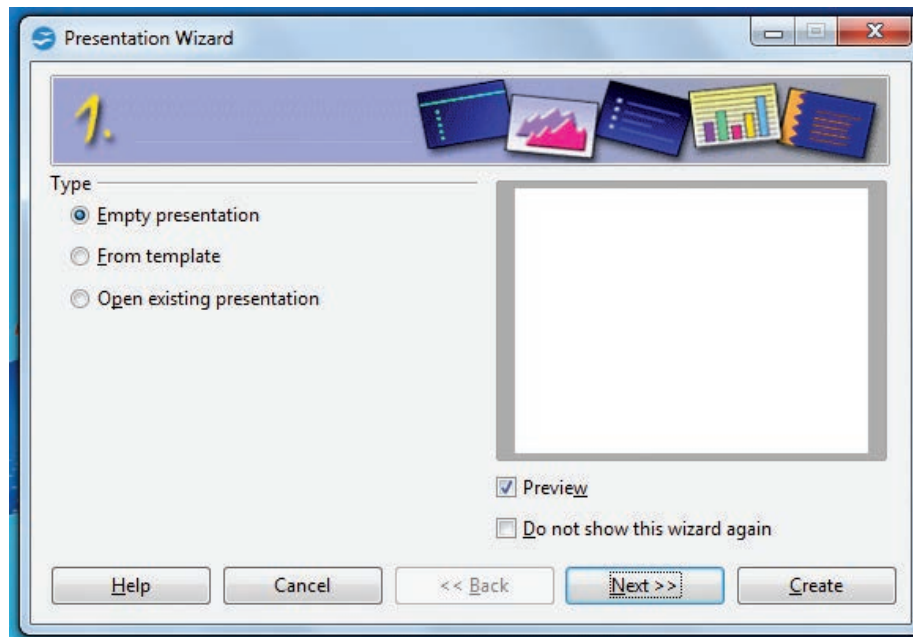

Figure 8.3 – Using the Presentation Wizard to choose the type of presentation

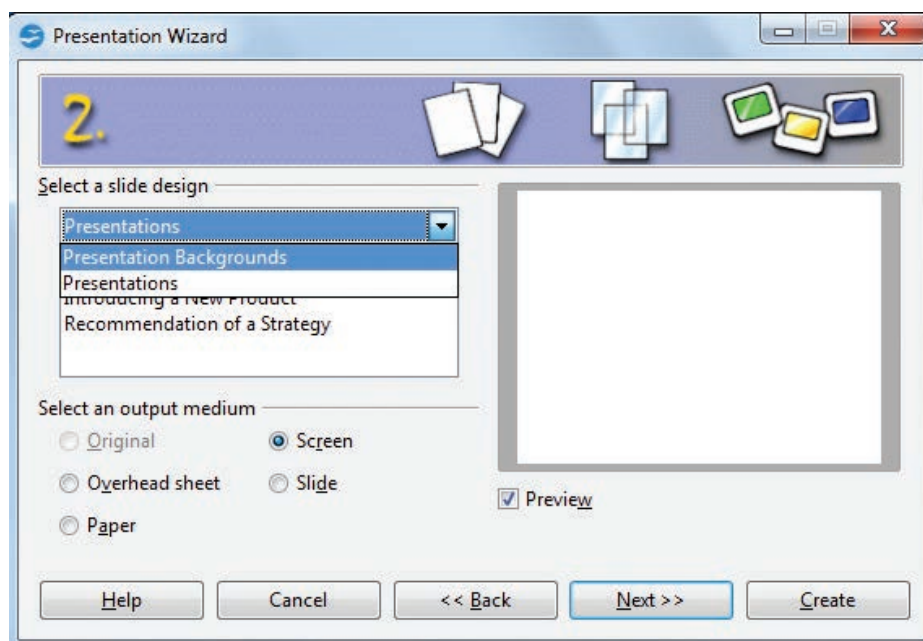

Figure 8.4 Wizard showing the main choices

select it. The preview of the same will be shown in the preview pane.

5. <Original> is an empty background. You can also select among three predefined Presentations: <Original>, Introducing a New Product, and Recommendation of a Strategy. (Figure 8.6).
6. Click an item to see a preview of the slide design in the Preview window.
7. Select how the presentation will be used under **Select an output medium**. Generally, presentations are created

for computer screen display, so select Screen option. (Figure 8.6).

8. Click Next. The Presentation Wizard step 3 appears (Figure 8.7). In this step, you can choose the desired slide transition from the **Effect** drop-down menu. Select the desired **speed** for the transition between the different slides in the presentation from the Speed drop-down menu. Medium is a good choice. Click Create. A new presentation is created. (Figure 8.8)

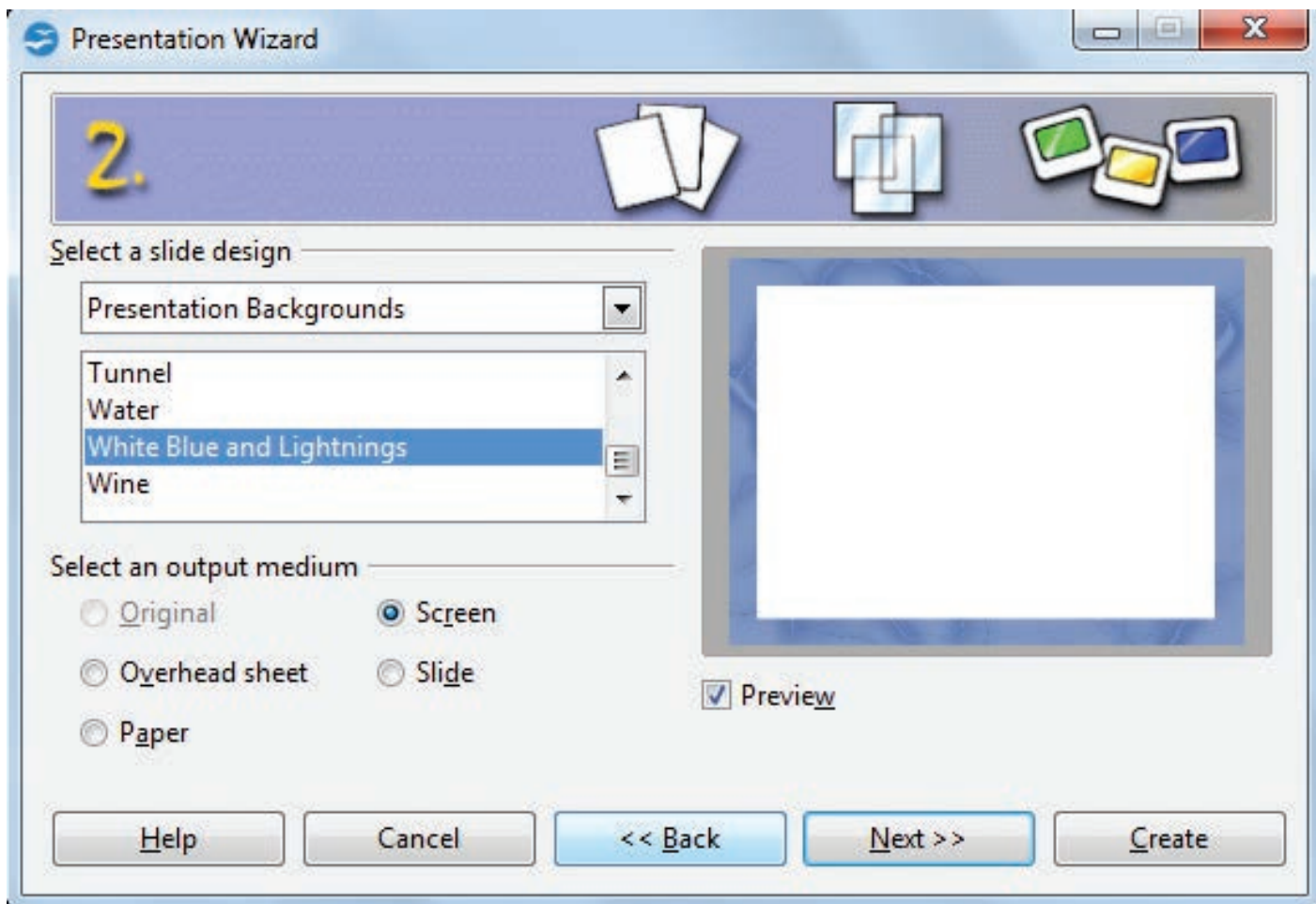

Figure 8.5 Selecting a slide design using Presentation Backgrounds

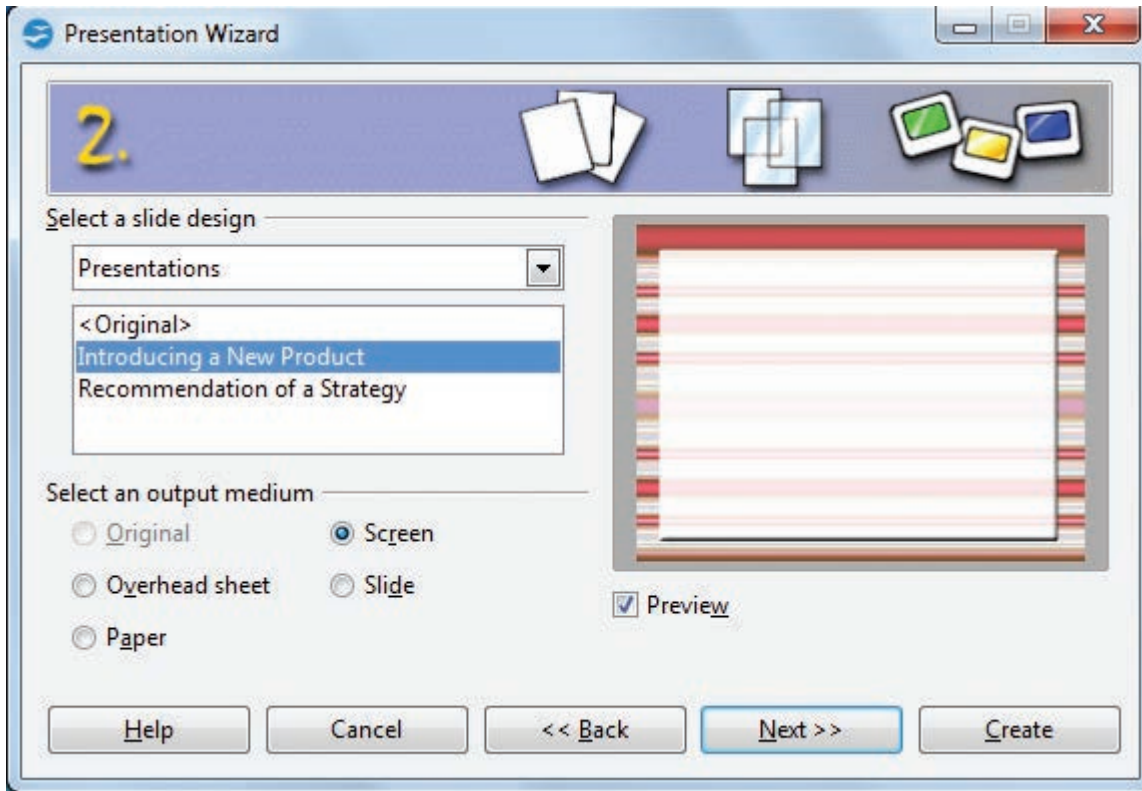

Figure 8.6 Selecting a slide design using Presentations

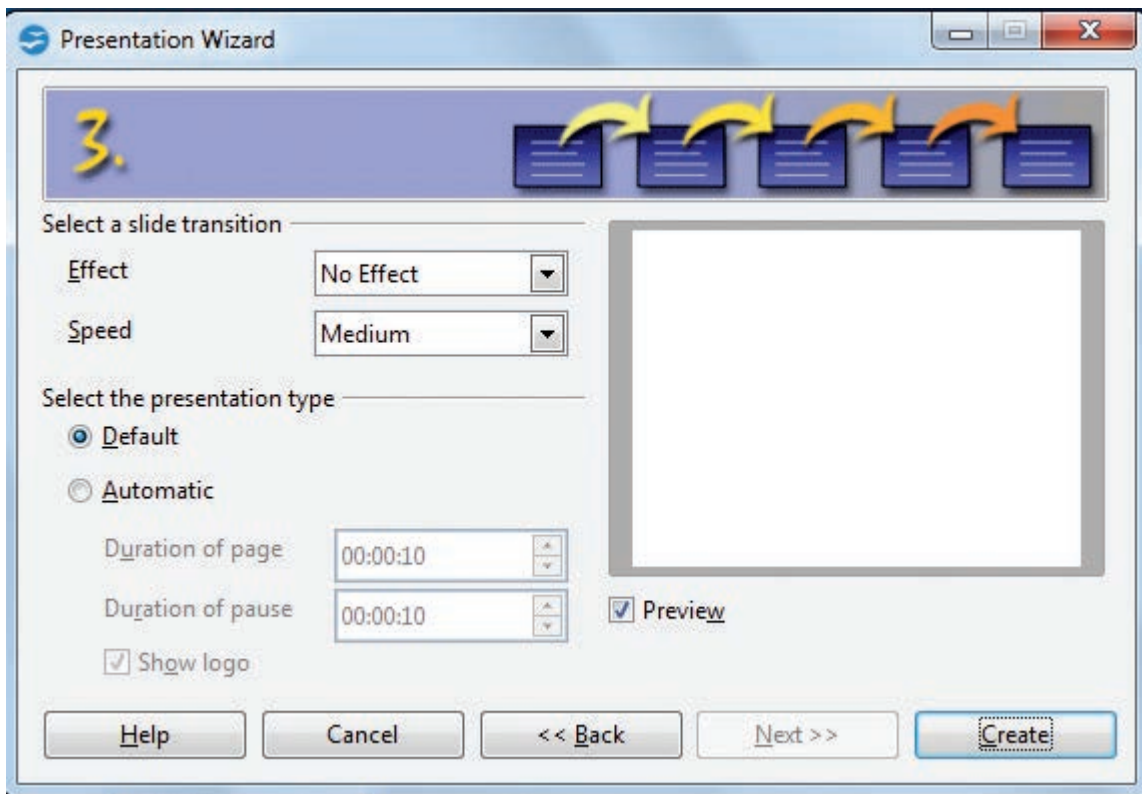

Figure 8.7 Selecting a slide transition effect

### 8.4.2. Using Template

- If you choose the option **From template**, it uses a template design already created as the basis for a new presentation. The wizard changes to show a list of available templates.

Choose the template that you want. (Figure 8.9).

- Introducing a New Product and Recommendation of a Strategy are pre-packaged presentation templates.

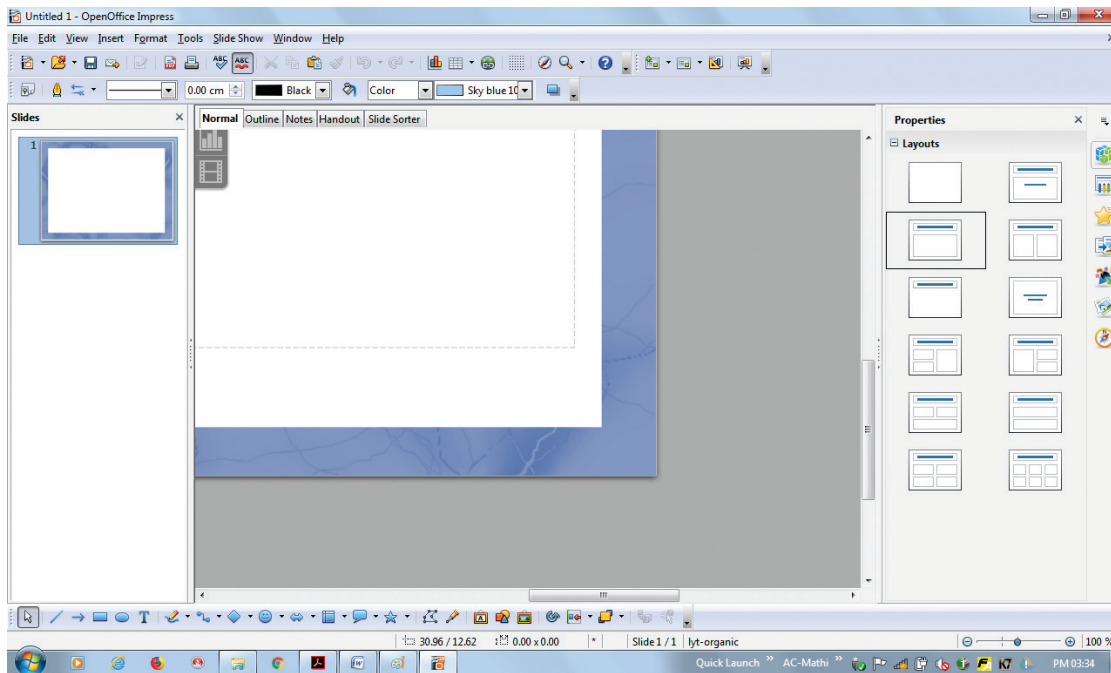

Figure 8.8 New presentation

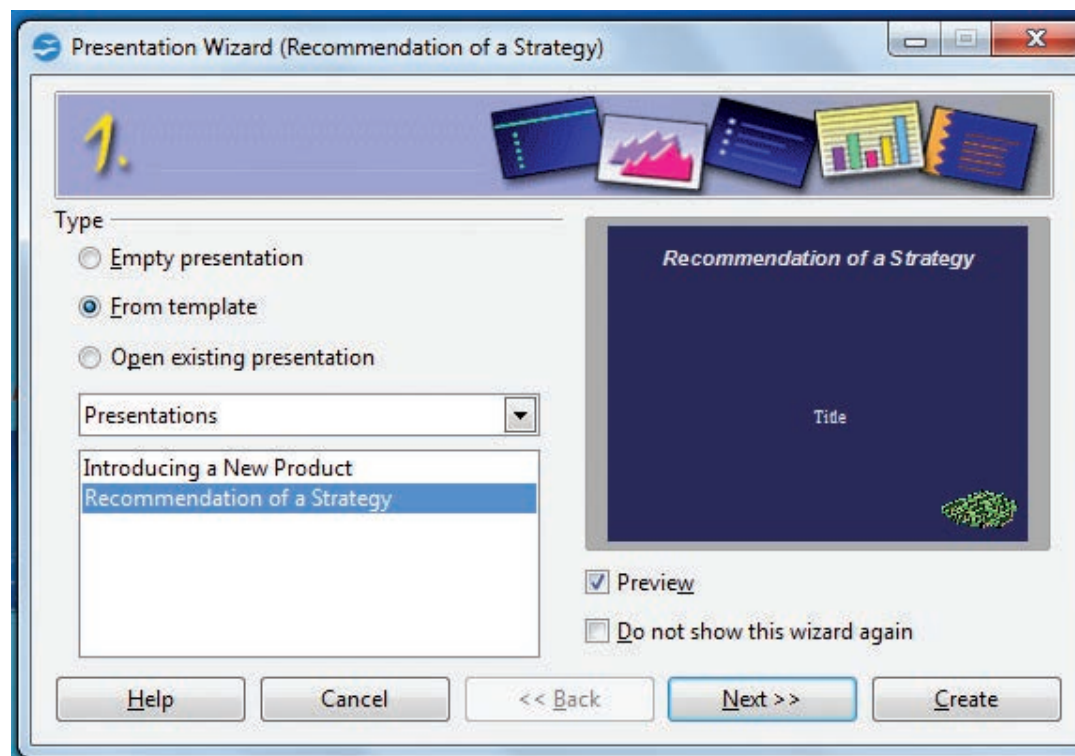

Figure 8.9 Opening a new presentation using From template option

### 8.4.3. Using Open existing presentation

- If you choose the option Open existing presentation, it helps in continuing the work on a previously created presentation.
- You have to open a presentation already prepared by clicking Open button. The wizard changes to show a list of existing presentations, from which you can choose the one that you want. (Figure 8.10).

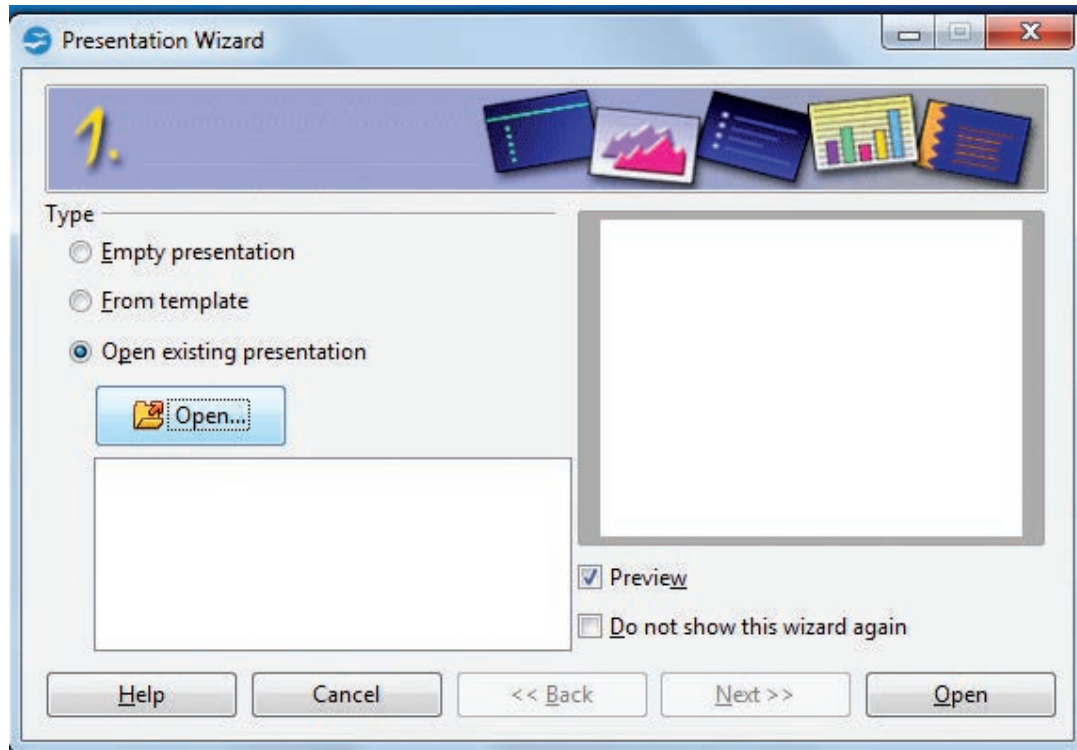

Figure 8.10 Opening a new presentation using Open existing presentation option

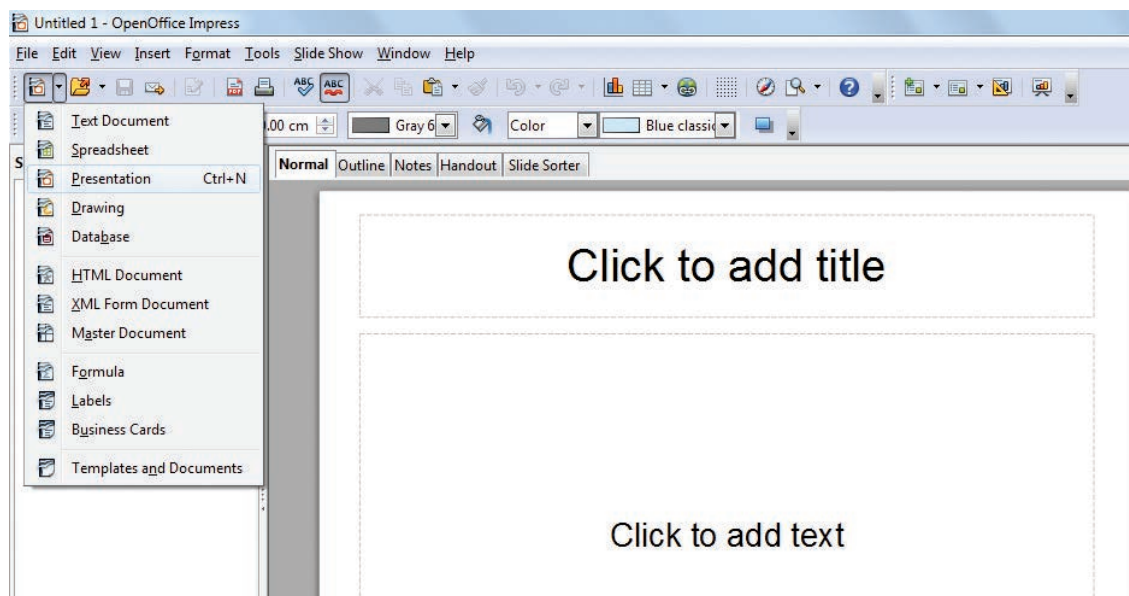

Figure 8.11 Opening a new presentation using New icon

### Tip Notes

#### First Spreadsheet

- If you do not want the wizard to start every time you start Impress, select the Do not show this wizard again checkbox.
- Leave the Preview checkbox selected, so templates, slide designs, and slide transitions appear in the preview box as you choose them.

toolbar and select Presentation from the drop-down menu (Figure 8.11).

3. Or else, choose **File** → **New** → **Presentation**. (Figure 8.12).

### 8.5. Parts of the main Impress window

The main Impress window (Figure 8.13) has three parts: the Slides pane, the Workspace and the Task pane. Additionally, several toolbars can be displayed or hidden during the creation of a presentation.

### Various ways of Starting Impress:

You can start Impress in various ways.

1. You can select the presentation from the system menu or the OpenOffice.org Quickstarter.
2. Or you can click the triangle to the right of the New icon on the main

### Tip Notes

You can remove the Slides pane or Tasks pane from view by clicking the Close (X) option in the upper right corner. You can also show or hide these panes using View → Slide Pane or View → Task Pane/Side bar.

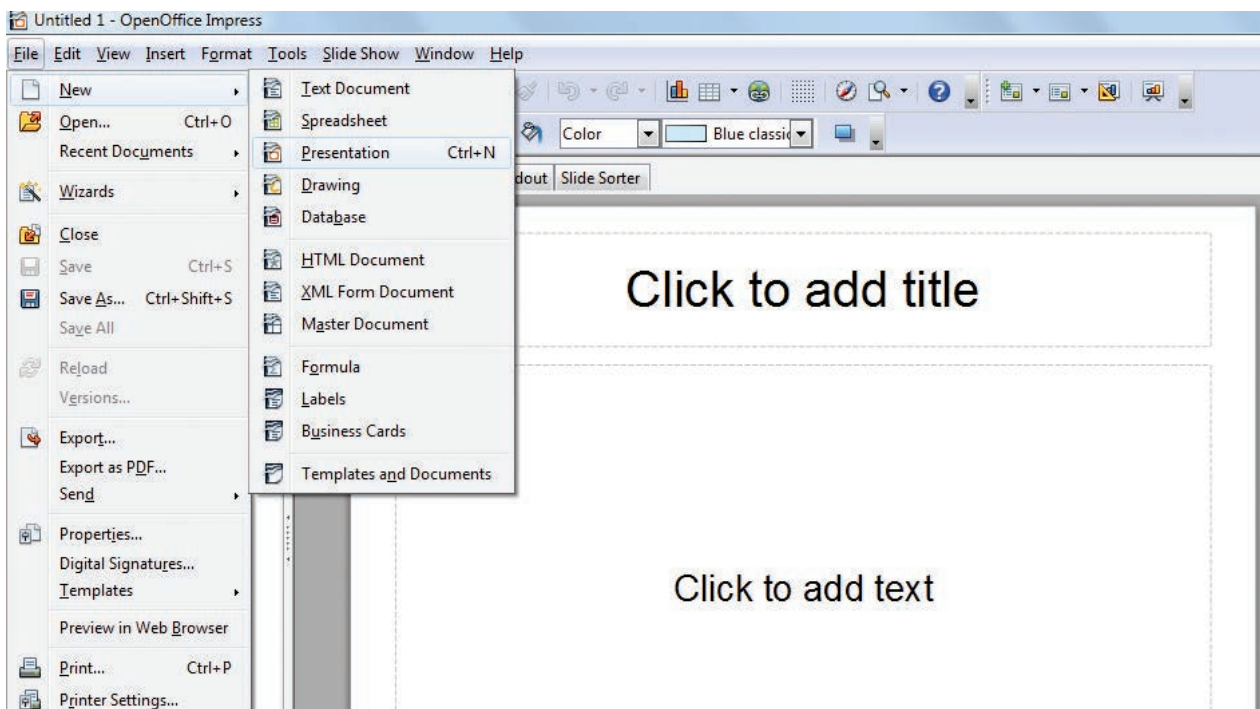

Figure 8.12 Opening a new presentation using File menu

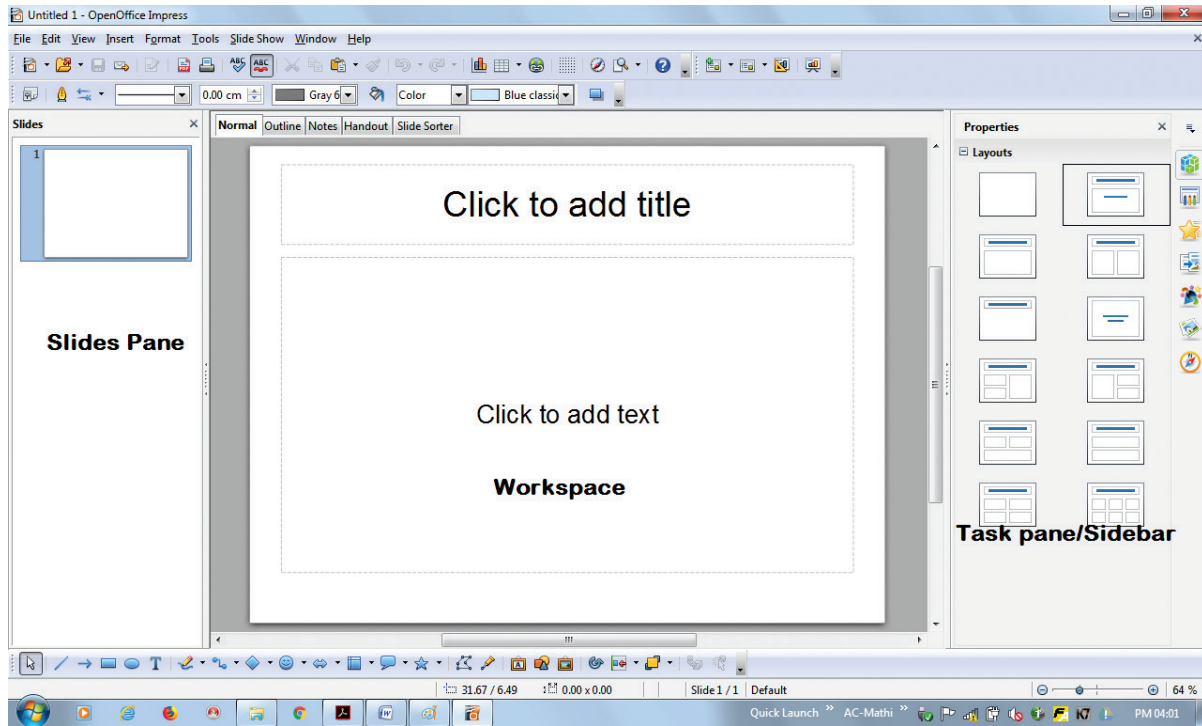

Figure 8.13 Main window of Impress

### 8.5.1. Slides pane

- The Slides pane contains thumbnail pictures of the slides in your presentation, in the order of our insertion of slides.
- Clicking a slide in this pane selects it and places it in the Workspace. While it is there, you can apply any changes that are desired to that particular slide.

Several additional operations can be performed on one or more slides in the Slides pane:

- Add new slides at any place within the presentation after the first slide.
- Mark a slide as hidden so that it will not be shown as part of the slide show.
- Delete a slide from the presentation if it is no longer needed.
- Rename a slide.
- Copy or move the contents of one slide to another (copy and paste, or cut and paste, respectively).

It is also possible to perform the following operations, other than using the Slides pane.

- Change the slide transition following the selected slide or after each slide in a group of slides.
- Change the sequence of slides in the presentation.
- Change the slide design. (A window opens allowing you to load your own design.)
- Change slide layout for a group of slides simultaneously. (This requires using the Layouts section of the Tasks pane.)



## 8.5.2. Tasks pane

The Tasks pane has five sections:

### 8.5.2.1. Master Pages

You define the page style for your presentation using Master Pages. Impress contains pre-packaged Master Pages (slide masters). One of them by default is blank, and the rest have a specific background. (Figure 8.14)



Figure 8.14 Master Pages

### 8.5.2.2. Layout

Pre-packaged layouts are shown. You can choose the one that you want, use it as it is or modify it to suit your own requirements. At present, it is not possible to create custom layouts. (Figure 8.15)

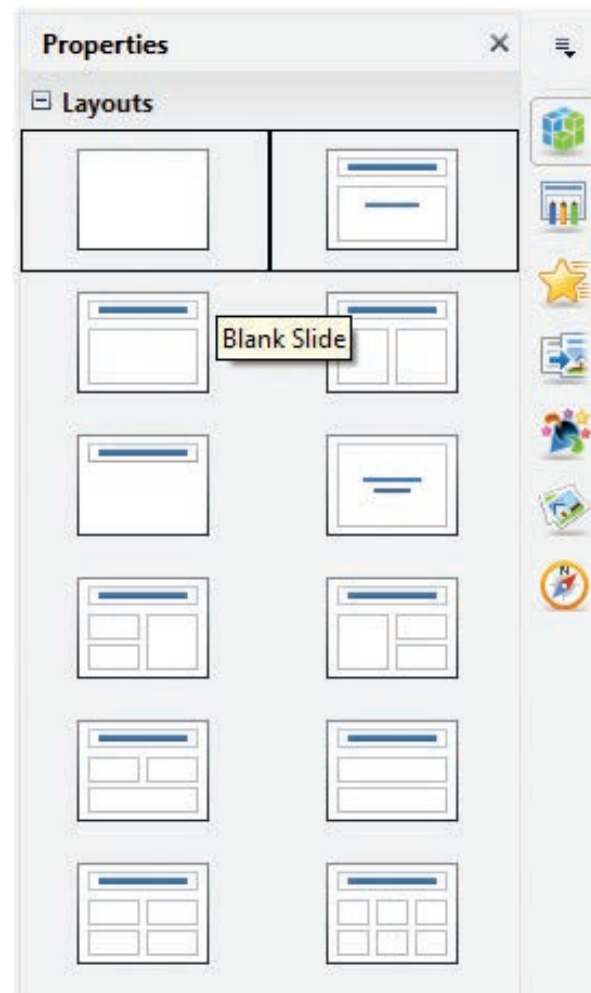

Figure 8.15 Layout

### 8.5.2.3. Table Design

Standard table styles are provided in this pane. You can further modify the appearance of a table with the selections to show or hide specific rows and columns, or to apply a banded appearance to the rows and columns. (Figure 8.16)

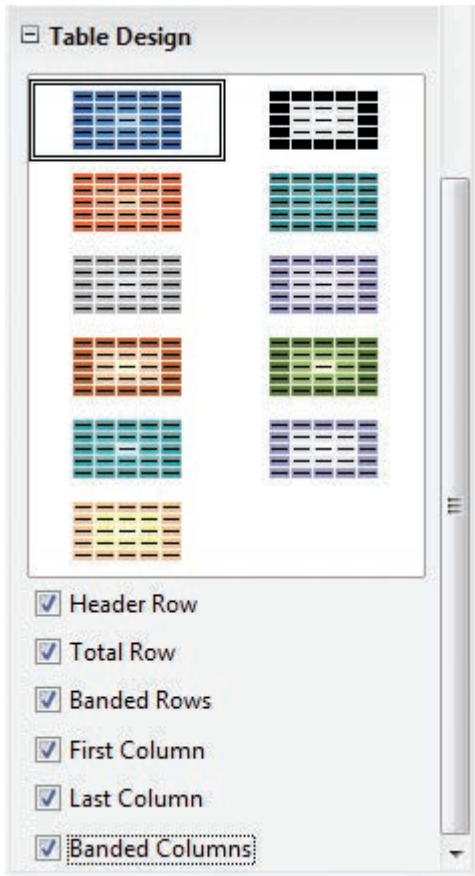

Figure 8.16 Table Design

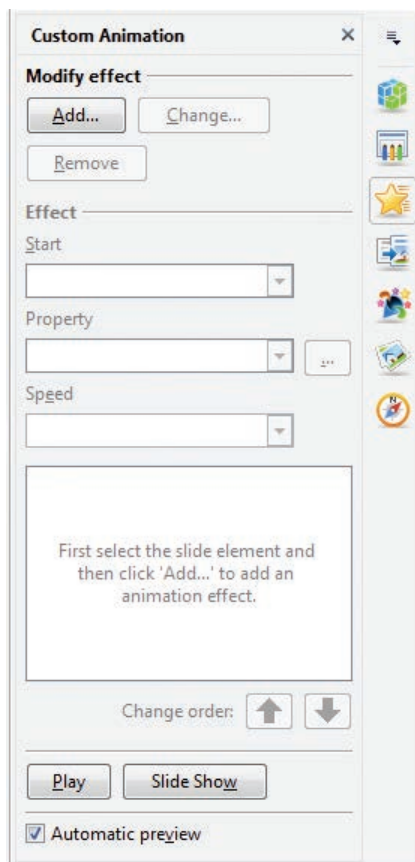

Figure 8.17 Custom Animation

### 8.5.2.4. Custom Animation

A variety of animations for selected elements of a slide are listed here. Animation can be added to selected elements of a slide and it can also be changed or removed later. (Figure 8.17)

### 8.5.2.5. Slide Transition

Transitions are available, including **No Transition**. You can select the transition speed (slow, medium, fast). You can also choose between an automatic or manual transition, and how long you want the selected slide to be shown (automatic transition only). (Figure 8.18)

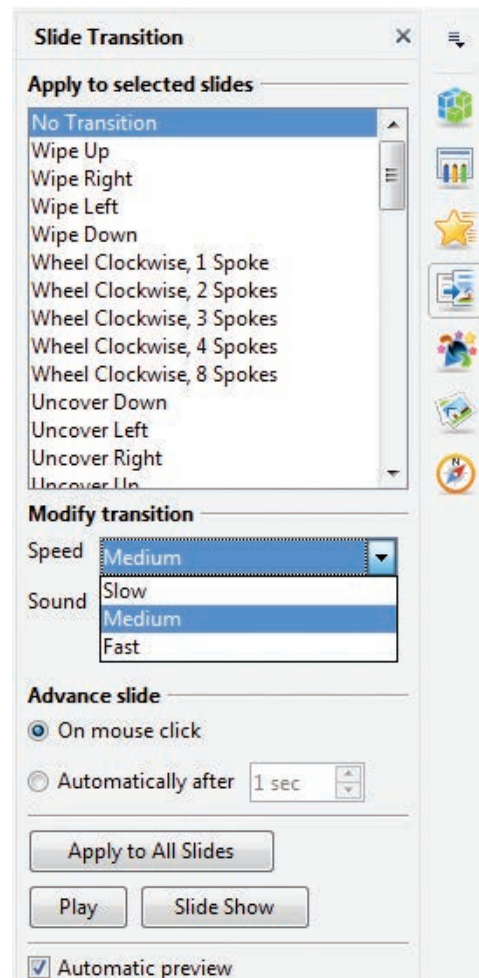

Figure 8.18 Slide Transition

## 8.6. Window elements of Impress

Figure 8.19 shows the elements of the Impress Window Open source application.

The window elements of Impress include Title Bar, Menu Bar, Tool Bar, Ruler Bar and the Scroll Bar which are similar to the elements in Open Office writer.

### 8.6.1. View Buttons:

The Workspace has five tabs: Normal, Outline, Notes, Handout, and Slide Sorter, as seen in Figure 8.19. These five tabs are called View Buttons.

### 8.6.2. Status Bar:

Status Bar is present at the bottom of your window, which gives you some

statistics about the file that you are viewing. It is a good practice to check the information shown there. In case you do not need the information in the Status Bar, you can hide it by selecting **View** → **Status Bar** from the main menu.

### 8.6.3. Navigator

The Navigator (Figure 8.20) displays all objects contained in a document. It provides another convenient way to move around a document and find items in it. The Navigator button is located on the Standard toolbar. You can also display the Navigator by choosing **Edit** → **Navigator** on the menu bar or pressing **Ctrl+Shift+F5**.

The Navigator is more useful if you give your objects (pictures, spreadsheets, and so on) meaningful names, instead of leaving them as the default “Object 1” and “Picture 1” as shown in Figure 8.20.

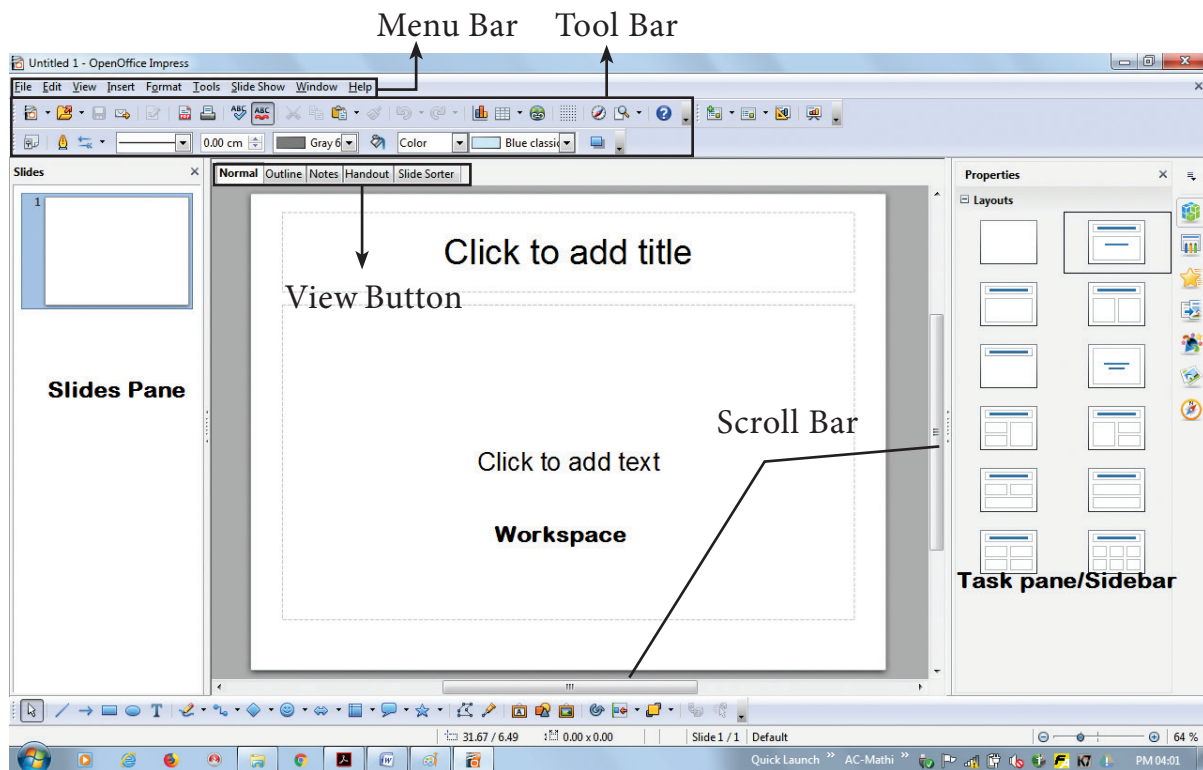

Figure 8.19 Window elements of Impress

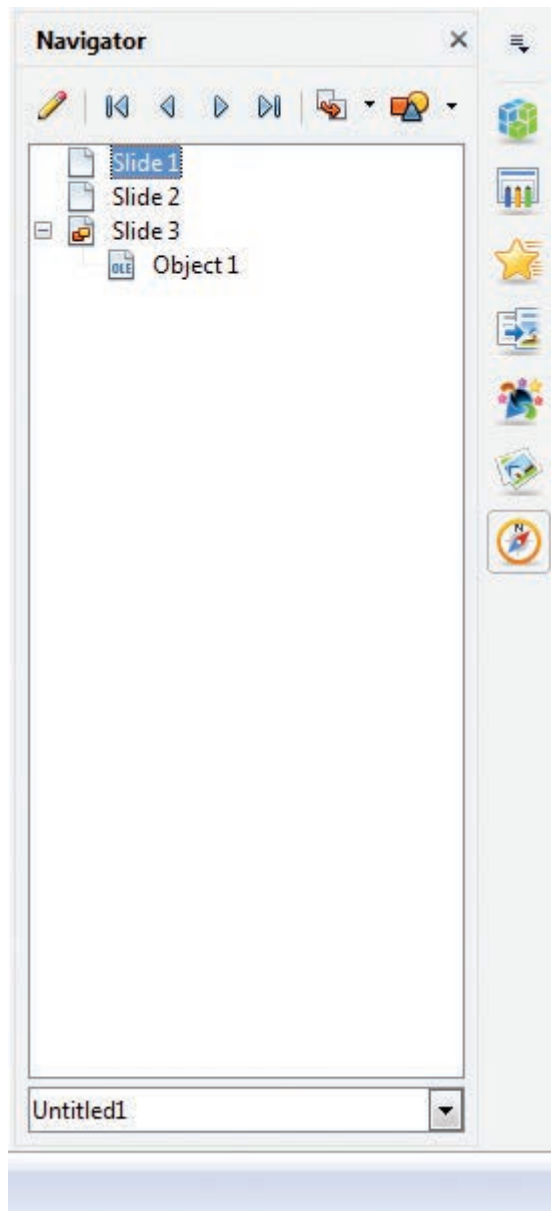

Figure 8.20 Navigator

## 8.7. Workspace

The Workspace has five tabs: Normal, Outline, Notes, Handout and Slide Sorter, as seen in Figure 8.19. These five tabs are called View Buttons. There are many toolbars that can be used during the slide creation; they are revealed by selecting them with **View** → **Toolbars**.

The actual Workspace section is below the View Buttons. This is where

you assemble the various parts of your selected slide. Each view is designed to ease the completion of certain tasks.

**Normal view** is the main view for creating individual slides. Use this view to format and design slides and to add text, graphics and animation effects.

**Outline view** shows topic titles, bulleted lists and numbered lists for each slide in outline format. Use this view to rearrange the order of slides, edit titles and headings, rearrange the order of items in a list and add new slides.

**Notes view** lets you add notes to each slide that are not seen when the presentation is shown.

**Slide Sorter view** shows a thumbnail of each slide in order. Use this view to rearrange the order of slides, produce a timed slide show, or add transitions between selected slides.

**Handout view** lets you print your slides for a handout. You can choose one, two, three, four, or six slides per page from **Tasks pane** → **Layouts**. Thumbnails can be re-arranged in this view by dragging and dropping them.

### 8.7.1. Normal view

There are two ways to place a slide in the Slide Design area of the Normal view: clicking the slide thumbnail in the Slides pane or using the Navigator.

To open the Navigator, click the Navigator button in the Standard Toolbar or press **Ctrl+Shift+F5** and select a slide

by scrolling down the Navigator list until you find the one that you want and then double-click it. (Figure 8.21)

### 8.7.2. Outline view

Outline view contains all the slides of the presentation in their numbered sequence. Only the text in each slide is shown. Slide names are not included.

Outline view serves for two purposes.

1) Making changes in the text of a slide:

- Add or delete text in a slide just as in the Normal view.
- Move the paragraphs of text in the selected slide up or down by using the up and down arrow buttons (Move Up

or Move Down) on the Text Formatting toolbar.

Change the outline level for any of the paragraphs in a slide using the left and right arrow buttons (Promote or Demote).

Both move a paragraph and change its outline level using a combination of these four arrow buttons.

2) Comparing the slides with your outline (if you have prepared one in advance). If you notice from your outline that another slide is needed, you can create it directly in the Outline view or you can return to the Normal view to create it, then return to review all the slides against your outline in the Outline view.

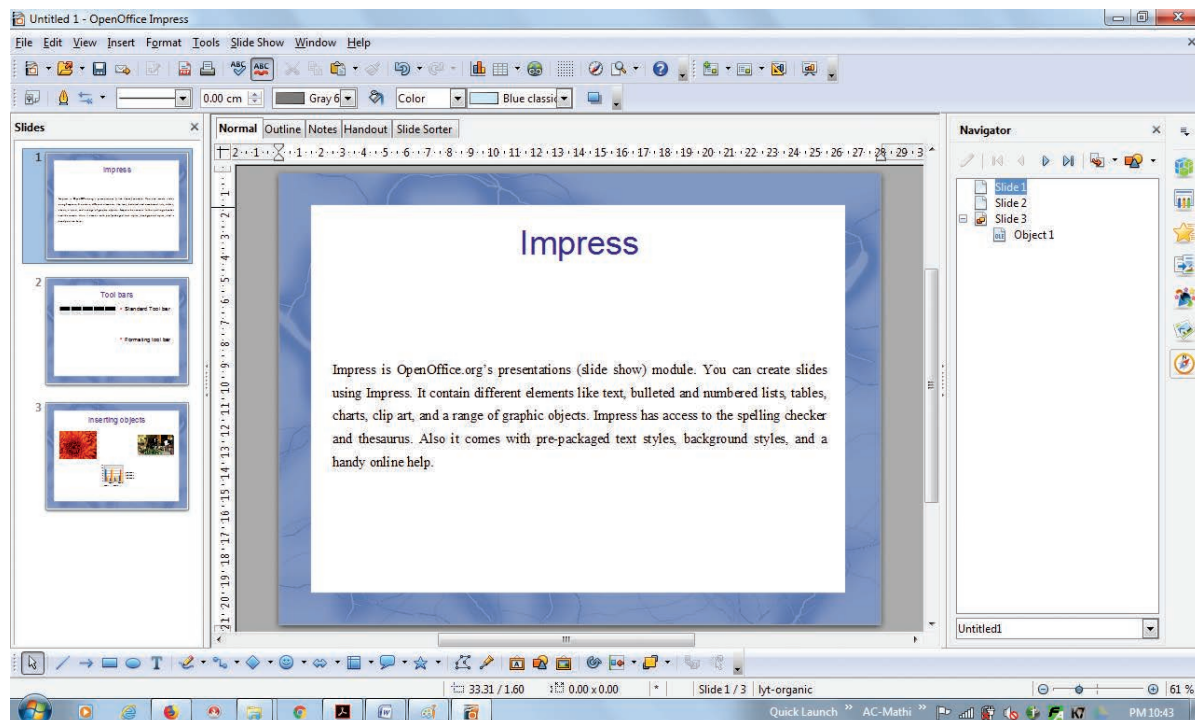

Figure 8.21 Presentation in Normal view

If a slide is not in the correct sequence, you can move it to its proper place:

- a) Click the slide icon of the slide that you wish to move, as indicated in Figure 8.22.
- b) Drag and drop it where you want.

### 8.7.3. Notes view

Use the Notes view to add notes to a slide:

- 1) Click the Notes tab in the Workspace (Figure 8.23).
- 2) Select the slide to which you will add notes.

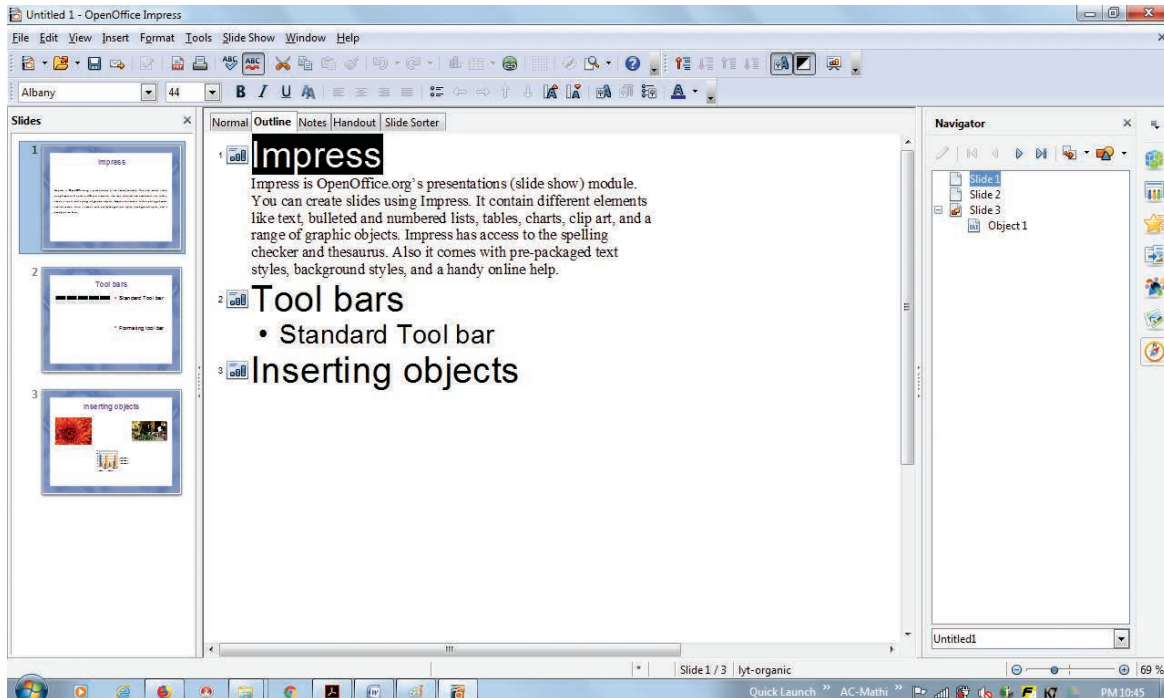

Figure 8.22 Presentation in Outline view

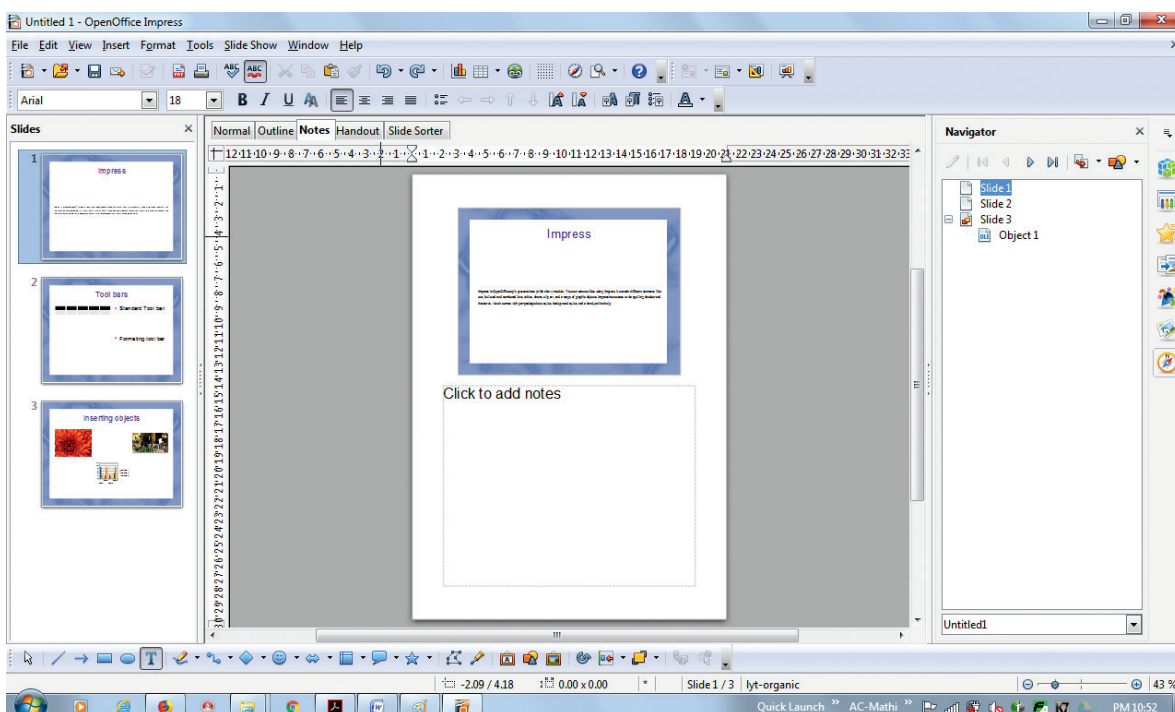

Figure 8.23 Presentation in Notes view

- Double-click the slide in the Slide pane, or
  - Double-click the slide's name in the Navigator.
- 3) In the text box below the slide, click on the words **Click to add notes** and begin typing.

You can resize the notes text box using the green resizing handles and move it by placing the pointer on the border, then click and drag. To make changes in the text style, press the **F11** key to open the **Styles and Formatting window**.

#### 8.7.4. Slide Sorter view

The Slide Sorter view contains all of the slide thumbnails (Figure 8.24).

Use this view to work with a group of slides or with only one slide.

Change the number of slides per row, if desired:

- 1) Check **View Toolbars Slide View** to show the Slide view toolbar (Figure 8.24 ).
- 2) Adjust the number of slides (up to a maximum of 15).
- 3) After you have adjusted the number of slides per row, **View Toolbars Slide View** will remove this toolbar from view.

To select a group of slides, use one of these methods:

- Use the **Control (Ctrl)** key: Click on the first slide and, while pressing Control, select the other desired slides.

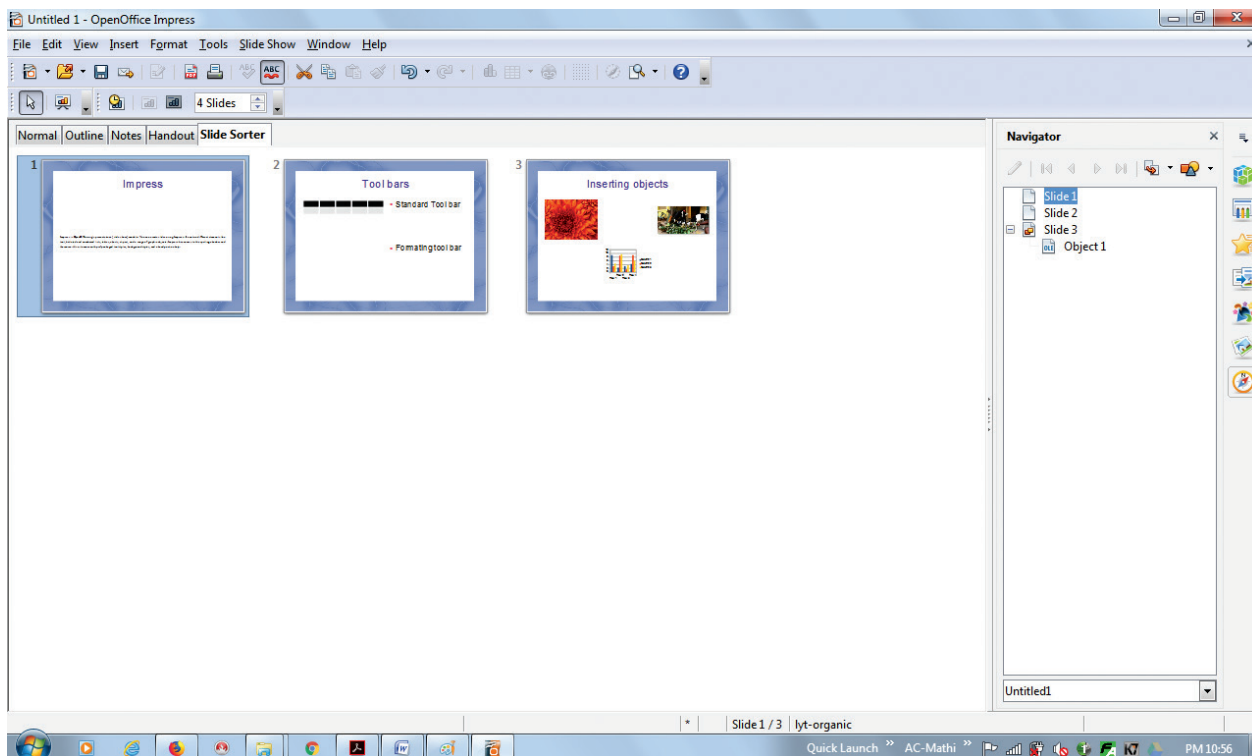

Figure 8.24 Presentation in Slide Sorter view

- **Use the Shift key:** Click on the first slide, and while pressing the Shift key, select the final slide in the group. This selects all of the other slides in between the first and the last.
- **Use the cursor:** Click on the first slide to be selected. Hold down the left mouse button.
- Drag the cursor to the last slide thumbnail.

A dashed outline of a rectangle forms as you drag the cursor through the slide thumbnails and a thick black border is drawn around the selected slides. Make sure that this rectangle includes all the slides you want to select. (Figure 8.25)

#### To move a group of slides:

- 1) Select the group of slides.
- 2) Drag and drop the group to their new location. The same vertical black line appears to show you where the group of

slides will go. You can work with slides in the Slide Sorter view as in the Slide pane.

To make changes, right-click a slide and do the following, using the pop-up menu:

- Add a new slide after the selected slide.
- Delete or rename the selected slide.
- Change the Slide Layout.
- Change the Slide Transition.
  - For one slide, click the slide to select it. Then add the desired transition.
  - For more than one slide, select the group of slides and add the desired transition.
- Mark a slide as hidden. Hidden slides will not be shown in the slide show.
- Copy or cut and paste a slide.

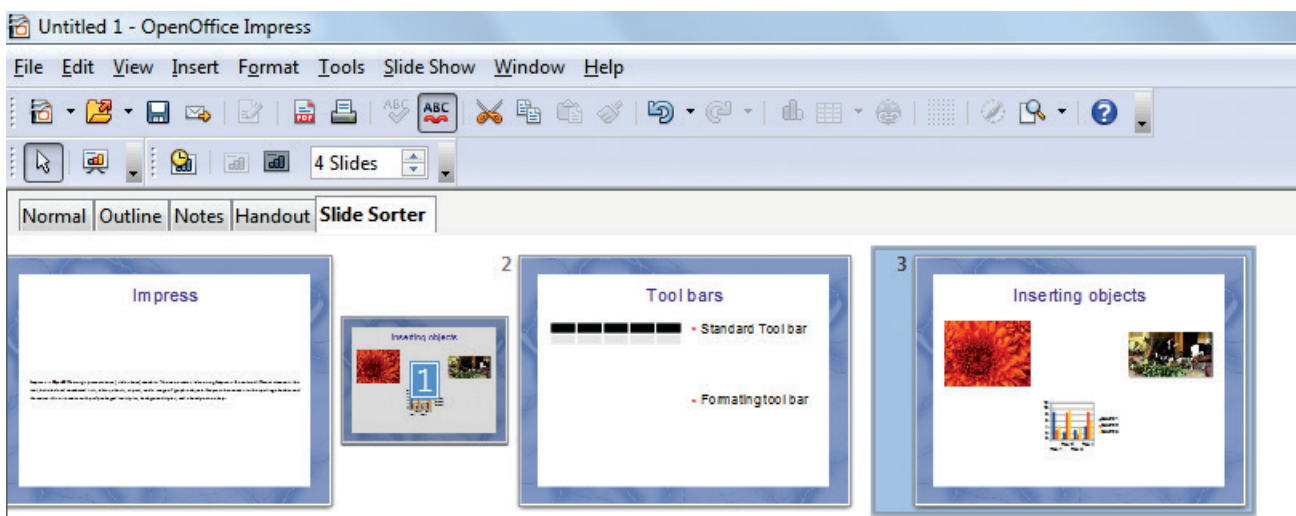

Figure 8.25 To move a slide in a presentation using the Slide Sorter



### 8.7.5. Handout view

Handout view is for setting up the layout of your slides for a printed handout. Click the Handout tab in the workspace, then choose Layout in the tasks pane (Figure 8.26). You can then choose to print one, two, three, four, or six slides per page.

#### To print a handout:

- 1) Select the slides using the Slide Sorter. (Use the steps listed in selecting a group of slides.)
- 2) Select **File Print** or press **Ctrl+P** to open the Print dialog box.
- 3) Select Options in the bottom left corner of the Print dialog box.
- 4) Check Handouts in the Contents section, and then click OK.
- 5) Click OK to close the Print dialog box.

### 8.8. Formatting a presentation

#### 8.8.1. Inserting, deleting and rearranging slides

Tip Note: Remember to save frequently while working on the presentation, to prevent any loss of information. You might also want to activate the AutoRecovery function (Tools → Options → Load/Save → General). Make sure that Save AutoRecovery information every is selected and that you have entered a suitable recovery frequency.

#### 8.8.2. Creating the first slide

The first slide is normally a title slide. Decide the layout as per its purpose of presentation. You can use the pre-packaged layouts available in the Layout section of the Tasks pane. Suitable layouts are Title Slide (which also contains a section for a subtitle) or Title Only, Title and Content, Title and two content and so on.

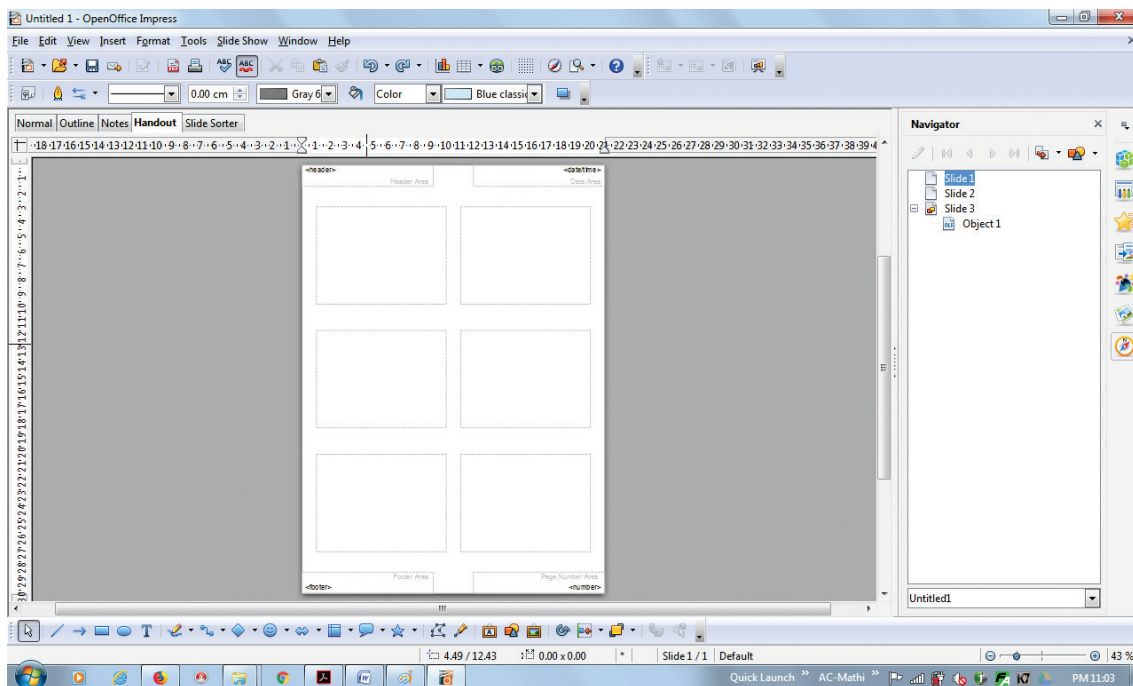

Figure 8.26 Presentation in Handout view

### Tip Notes

If you do not know the names for the pre-packaged layouts, you can use the tooltip feature. Position the cursor on an icon in the Layout section (or on any toolbar icon) and its name will be displayed in a small rectangle. If the tooltips are not enabled, you can enable them. From the main menu, select **Tools Options OpenOffice.org General Help** and mark the Tips checkbox. If the Extended tips checkbox is also marked, you will get more detailed tooltip information, but the tooltip names themselves will not be provided.

- Adjustments to the formatting of the title can be done by pressing the **F11** key, right-clicking the Title presentation style entry, and selecting Modify from the pop-up menu.
  - If you are using the Title Slide layout, click on “**Click to add text**” to add a subtitle. Proceed as above to make adjustments to the formatting if required. (Figure 8.27)
- 8.8.3. Inserting additional slides**
- The steps for inserting additional slides are basically the same as for selecting the title page. It is a process that has to be repeated for each slide.
- Unless you are using more than one slide master, your only concern is the Layouts section of the Tasks pane (Figure 8.28).
- First insert all the slides that are needed as per your outline. Only after this, you should begin adding special effects such as custom animation and slide transitions.

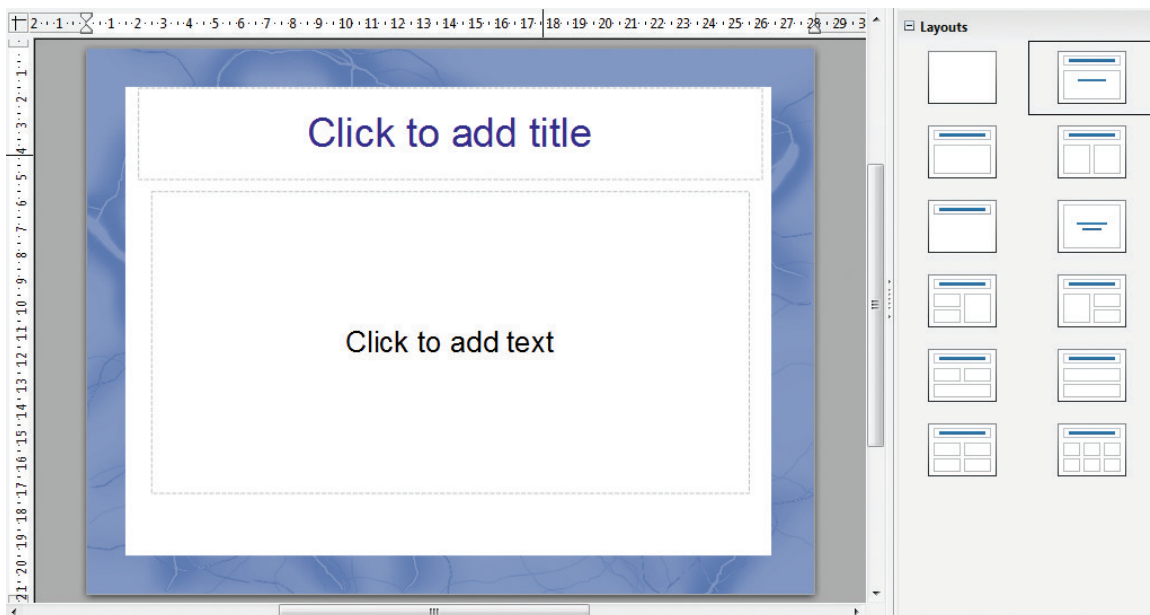

Figure 8.27 Creating the first slide

**Step 1:** Insert a new slide. This can be done in a variety of ways.

- Insert → Slide.
- Right-click on the present slide, and select Slide → New Slide from the pop-up menu. (Figure 8.28).
- Click the empty space after the last slide also to create a new slide by right clicking New Slide. (Figure 8.29)
- Click the Slide icon in the Presentation toolbar.

**Step 2:** Select the layout slide that best fits your needs. (Figure 8.28).

**Step 3:** Modify the elements of the slide like removing unneeded elements, adding needed elements (such as pictures), and inserting text.

#### 8.8.4. Deleting a Slide

You can delete a slide at any time using the following procedure.

- Select the slide you want to delete

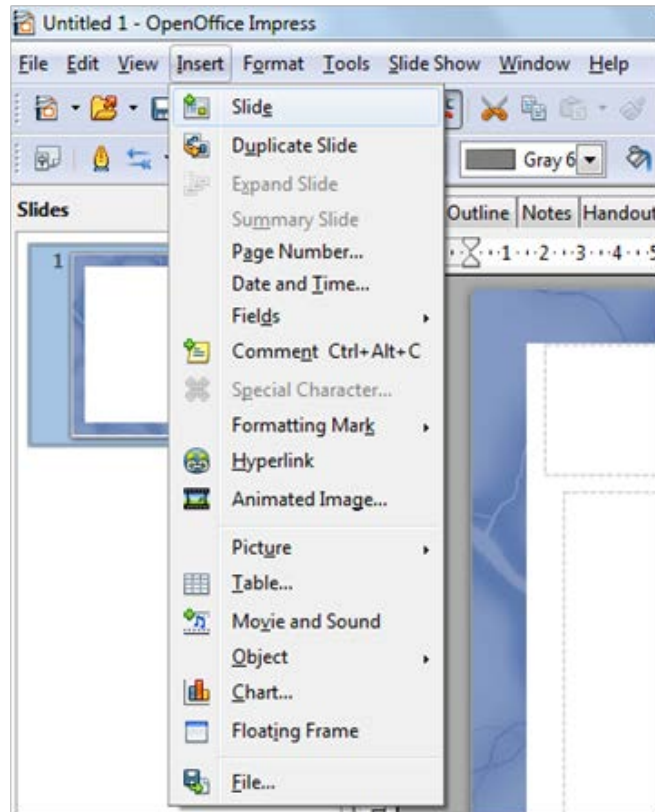

Figure 8.28 Inserting a new slide using Right Clicking on the previous slide

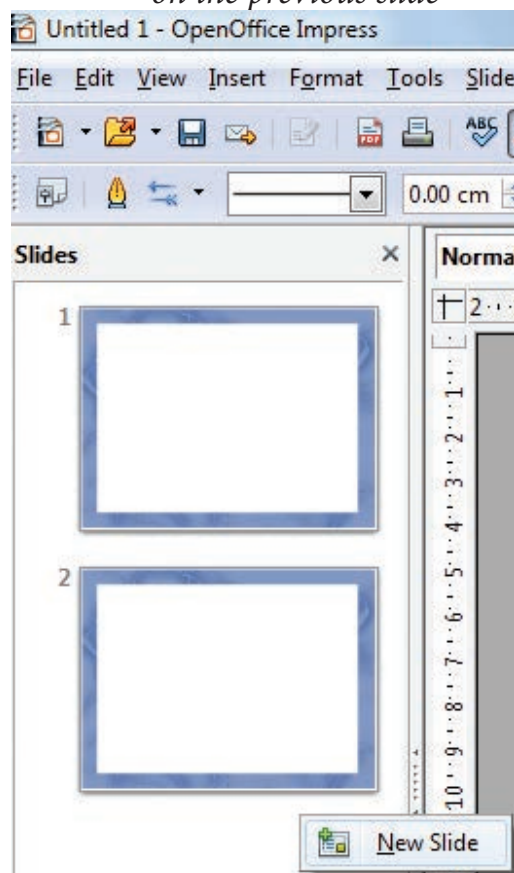

Figure 8.29 Inserting a new slide using Right Clicking in the empty space after the last slide

- Click **Edit** → **Delete** slide (Refer Figure 8.30)

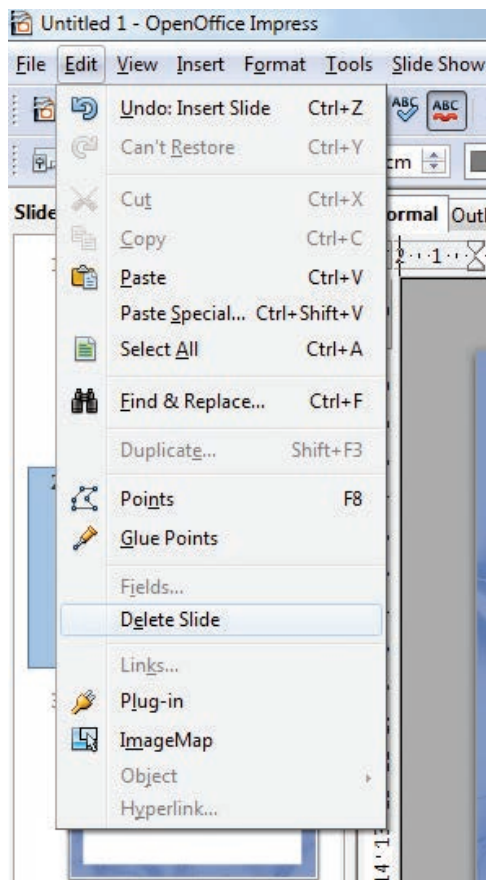

Figure 8.30 Deleting a slide using Edit menu

- Or else, right click the slide and choose Delete slide from the pop-up menu. (Figure 8.31)

#### Tip Notes

The same procedure can be followed by using the Slide sorter view also to delete a single slide or multiple slides.

#### 8.8.5. Rearranging slides

If you want to rearrange the slides, you need to follow the procedure below.

- Select the slide that you want to rearrange.

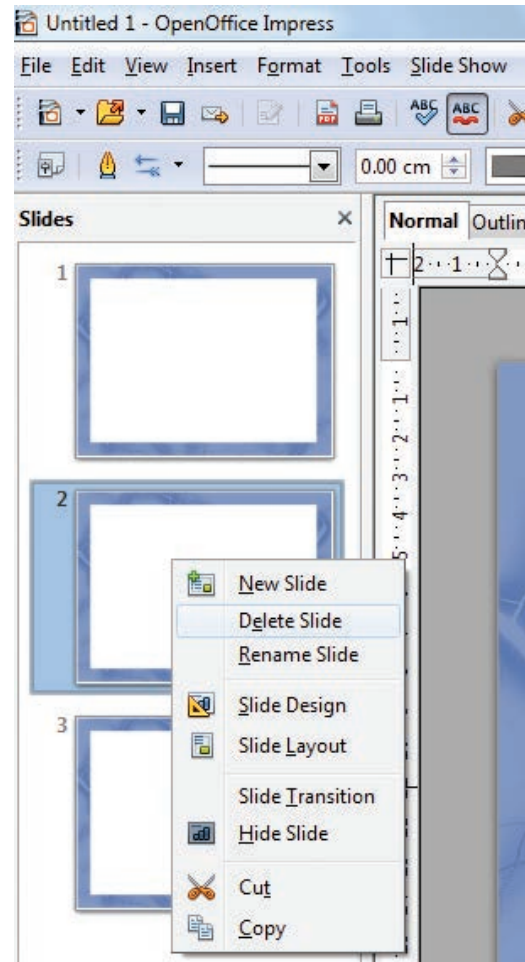

Figure 8.31 Deleting a slide using Right click

- Drag that slide to the desired position by holding the mouse using left click.
- Release the mouse once you drag the slide to the desired place. (Figure 8.32)

#### Tip Notes

The same can be done using the Slide sorter view.

#### 8.9. Running the slide show

To run the slide show, do one of the following:

- Click Slide Show → Slide Show on the main menu bar. (Figure 8.33).

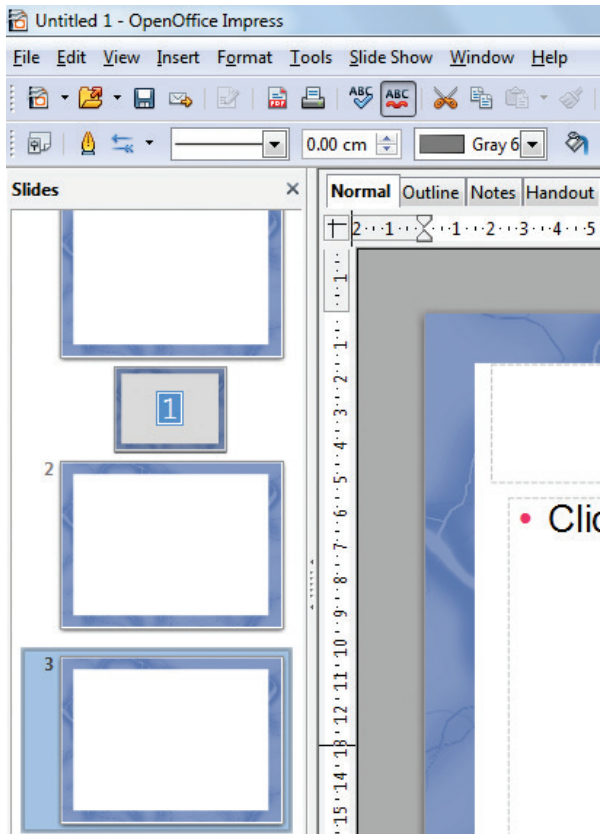

Figure 8.32 Rearranging the slide using

- Click the Slide Show button on the Presentation toolbar or the Slide Sorter toolbar (Figure 8.34).
- Press F5 or F9.
- If the slide transition is Automatically after x seconds, let the slide show run by itself.
- If the slide transition is On mouse click, do one of the following to move from one slide to the next.
  - Use the arrow keys on the keyboard to go to the next slide or to go back to the previous one.
  - Click the mouse button to advance to the next slide.
  - Press the Spacebar on the keyboard to advance to the next slide.

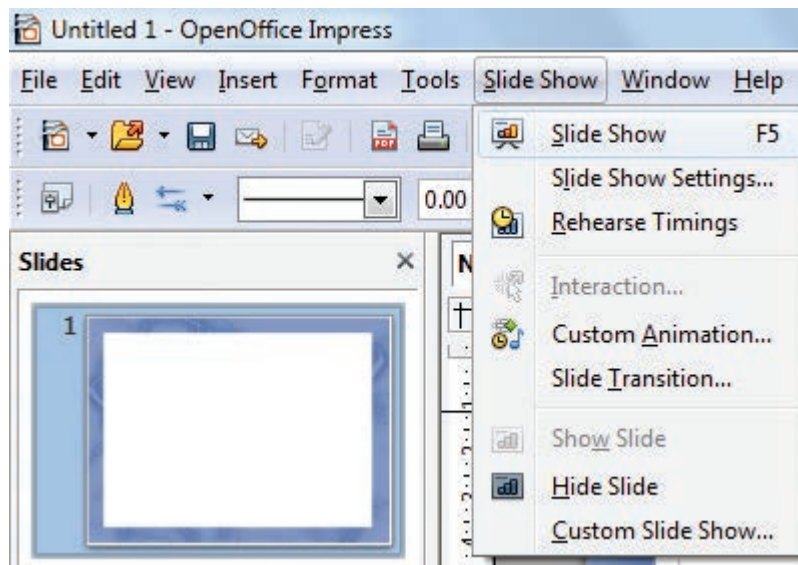

Figure 8.33 Running Slideshow using Slideshow menu

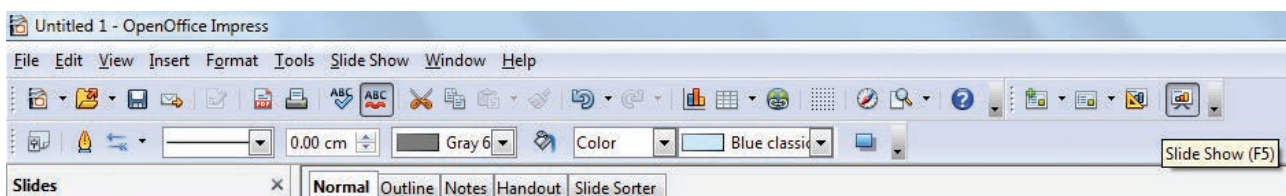

Figure 8.34 Running Slideshow using Slideshow button from the Toolbar

- When you advance past the last slide, the message “Click to exit presentation...” appears. Click the mouse or press any key to exit the presentation.
- To exit the slide show at any time, including at the end, press the Esc key.

### 8.10. Saving a Presentation

In order to save a presentation Click File → Save (Figure 8.35)

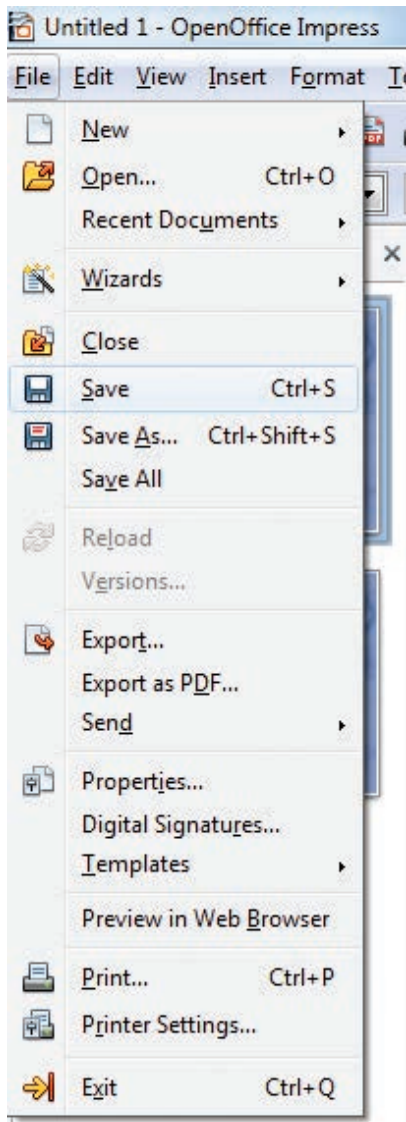

Figure 8.35 Saving a presentation using File menu

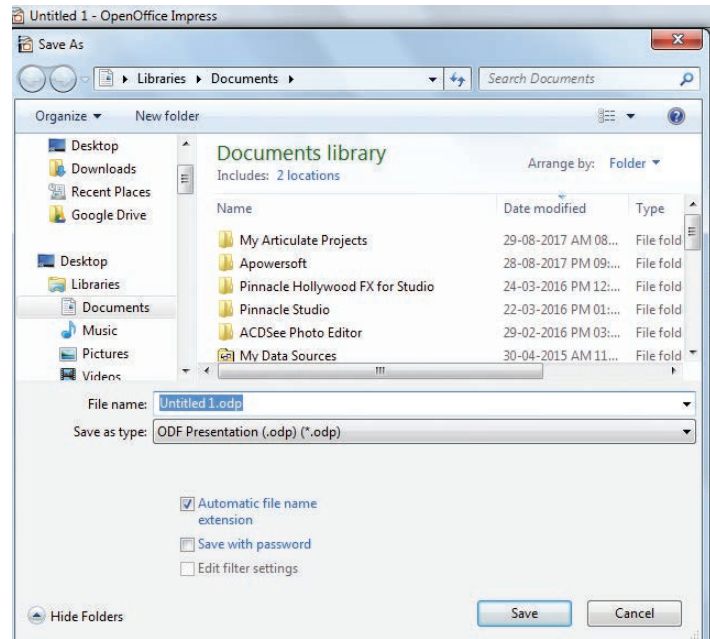

Figure 8.36 Save dialog box.

- After giving save option, Impress will open a dialog box asking the name in which this file should be saved (Figure 8.36)
- The default file extension for Impress is .odp.

#### Tip Notes

You can also use Save As option from the File menu. The difference between Save and Save As is Save option will save the presentation in the folder specified by you. Save As will save another copy of the same file either in the same folder or in a different folder specified by you.

- Type the name of the file you want to give in the text box space after **File Name** in the dialog box. (Figure 8.36).
- You can save the presentation as a PPT presentation also. (Figure 8.37)

- You can also export the presentation directly as pdf. (Figure 8.38)
- Figure 8.39 Shows exporting the presentation directly as PDF.

### 8.11. Master slide

A slide master is a slide that is used as the starting point for other slides. It is similar to a page style in Writer: it controls the basic formatting of all slides based on it. A slide show can have more than one slide master.

#### Tip Notes

Three terms are used for this concept. Master slide, slide master and master page all refer to a slide which is used to create other slides.

A slide master has a defined set of characteristics, including the background color, graphic, or gradient; objects (such as logos, decorative lines and other graphics) in the background; headers and footers; placement and size of text frames; and the formatting of text.

All of the characteristics of slide masters are controlled by styles. The styles of any new slide you create are inherited from the slide master from which it was created. In other words, the styles of the slide master are available and applied to all slides created from that slide master. Changing a style in a slide master result in changes to all the slides based on that slide master; it is, however, possible to modify each individual slide without affecting the slide master.

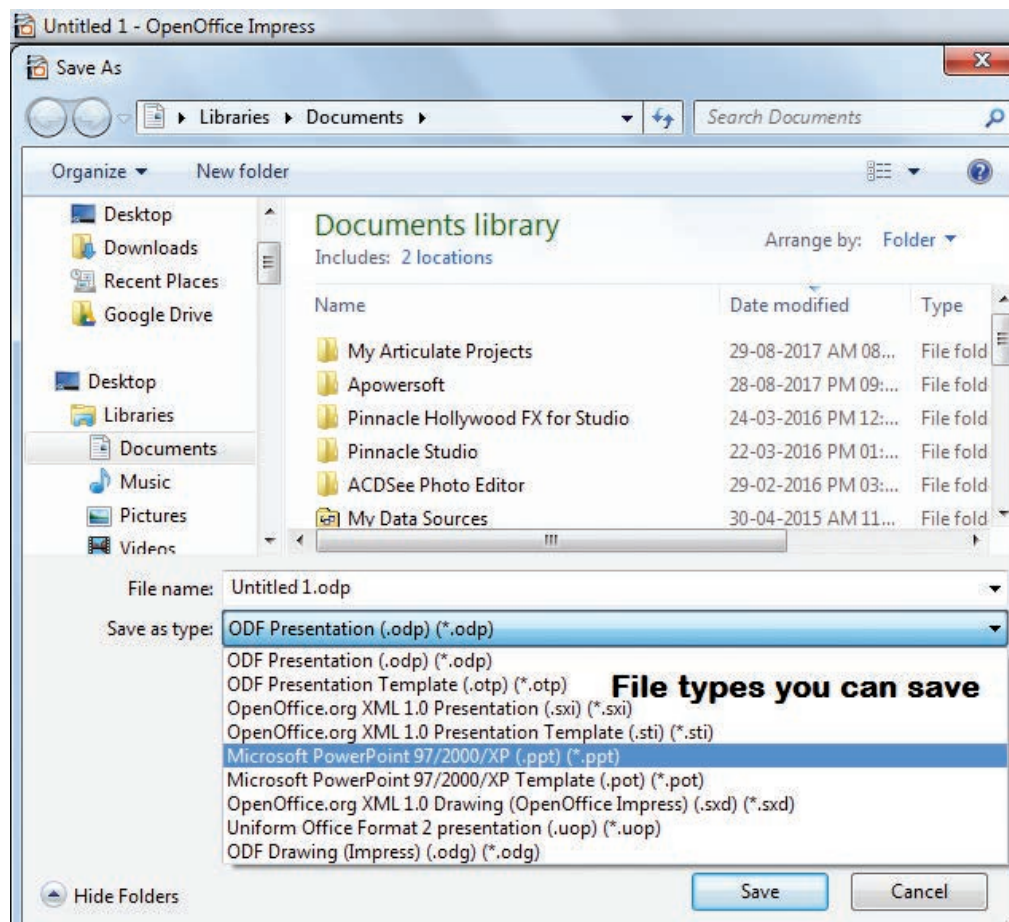

Figure 8.37 Saving a presentation under various File types

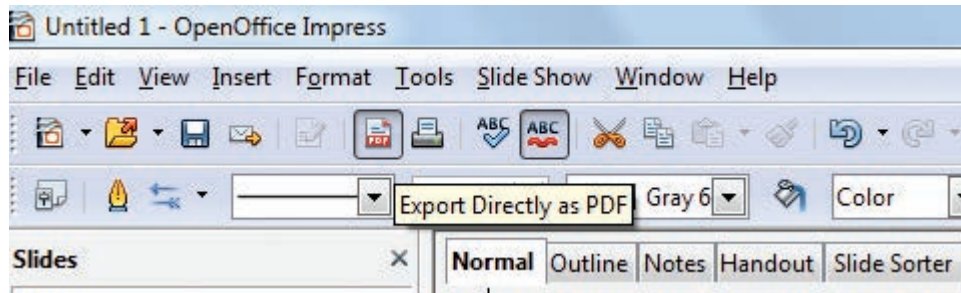

Figure 8.38 Export the presentation directly as PDF

### Tip Notes

Though it is highly recommended to use the slide masters whenever possible, there are occasions where manual changes are needed for a particular slide, for example to enlarge the chart area when the text and chart layout is used.

The pre-packaged presentation styles can be modified, but new

presentation styles cannot be created.

Figure 8.39 Shows the Slide Master.

- **Click View → Master → Slide Master**

It is possible to view the Master slides in two styles:

1. Slide Master
2. Notes Master

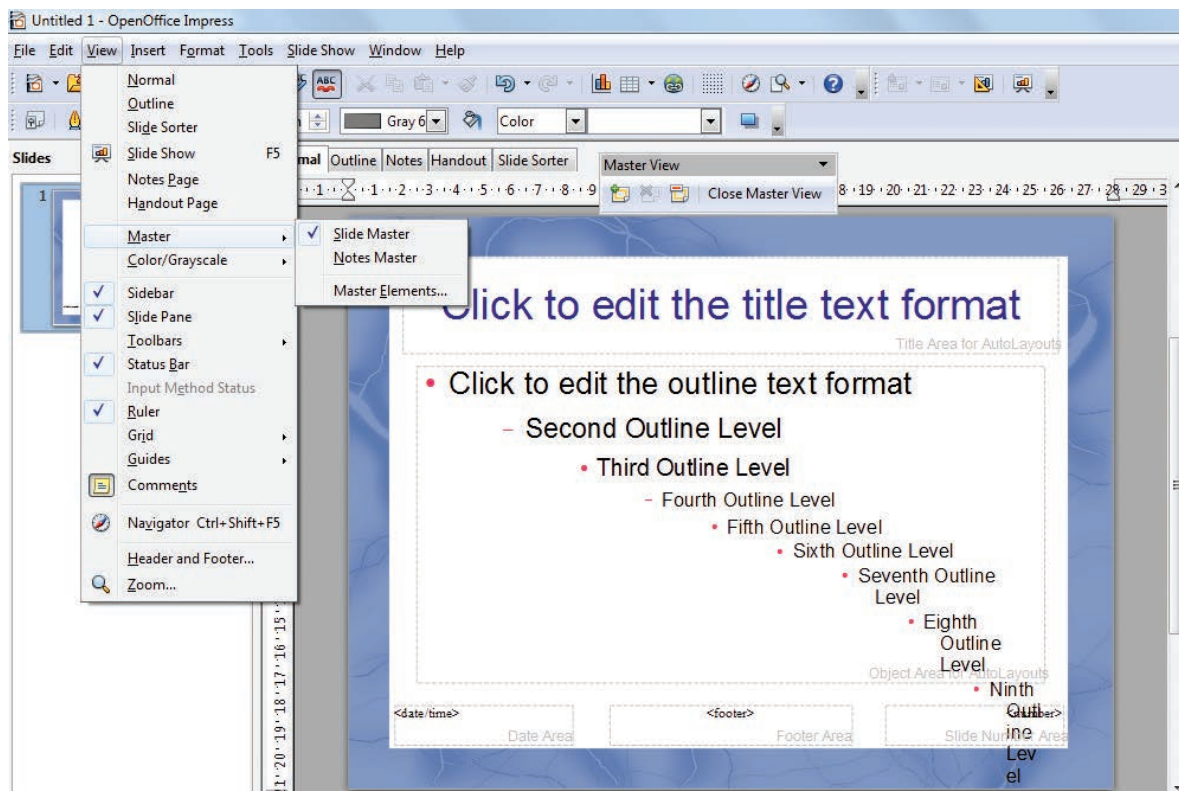

Figure 8.39 Slide Master View



- A New Master slide can be created either by using the Master View dialog box or by right clicking slides in the Slides pane. (Figure 8.41)
- The renaming of the Master Slide is also done by the same procedure.
- Master Slide will be closed by using the Close Master View in the Master View dialog box .

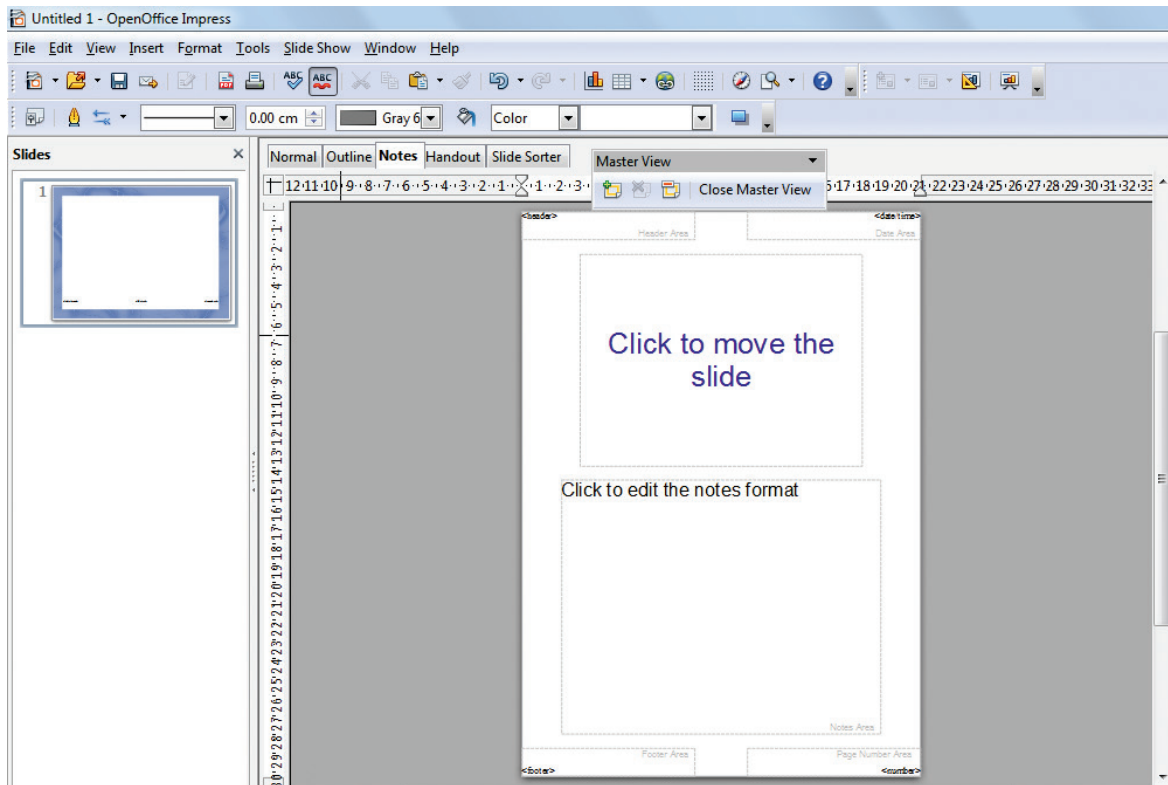

Figure 8.40 Notes Master View

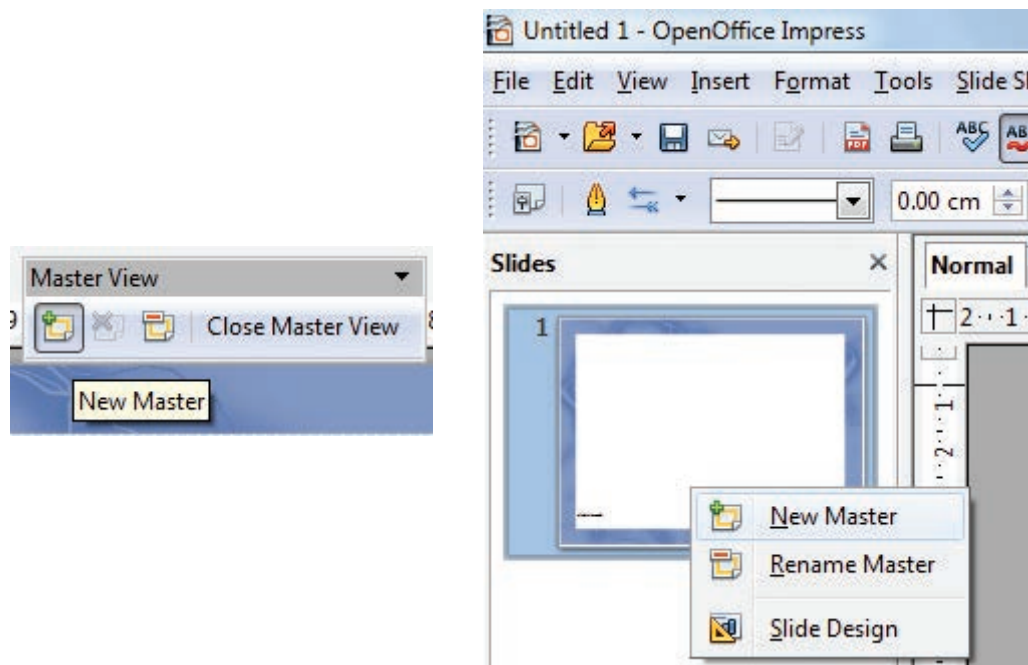

Figure 8.41 Creating New Master using Master View and right click option

## 8.12. Creating Graphic Objects

You can create your own graphics using the drawing tools available in Impress. Impress contains a number of advanced drawing functions. To create more advanced graphic objects, you can use OpenOffice.org to draw and import the graphic object created into an Impress slide.

### 8.12.1. The Drawing toolbar

The Drawing toolbar contains tools that are used to create graphic objects. If this toolbar is not showing, select **View** → **Toolbars Drawing** from the main menu bar.

- Select: selects objects. You can select multiple objects by dragging the mouse.
- Line: draws a straight line.
- Arrow: draws a straight line ending with an arrowhead. The arrowhead will be placed where you release the mouse button.
- Rectangle: draws a rectangle. Press the Shift button to draw a square.
- Ellipse: draws an ellipse. Press the Shift button to draw a circle.
- Text: creates a text box with the text aligned horizontally.
- Vertical text: creates a text box with the text aligned vertically.
- Curve: draws a curve.
- Connectors: draws a connector line between two figures. Click the black triangle for additional connectors.

## 8.13. Inserting images

In order to insert an image in OpenOffice Impress, place the cursor in the place where you want the image to be inserted. Then, **Click Insert** → **select Picture** → **From File** option from the Insert menu. Figure 8.44.

OpenOffice Impress will display the dialog box, where you can select the image from the specific location and select open. The image will be inserted in the specified location. Figure 8.44.

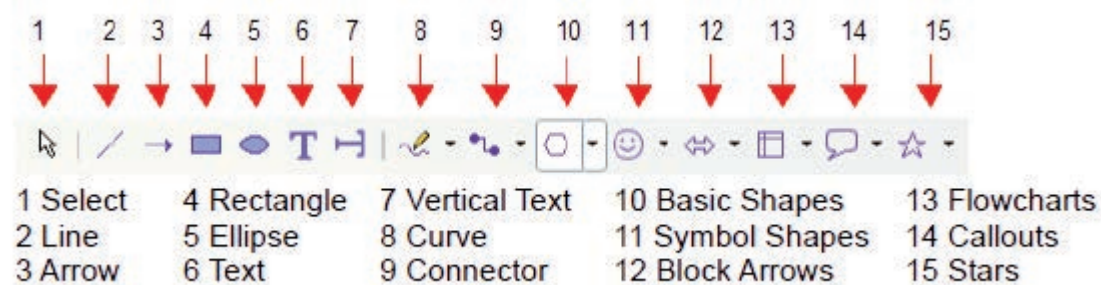

Figure 8.42 The Drawing Tool Bar

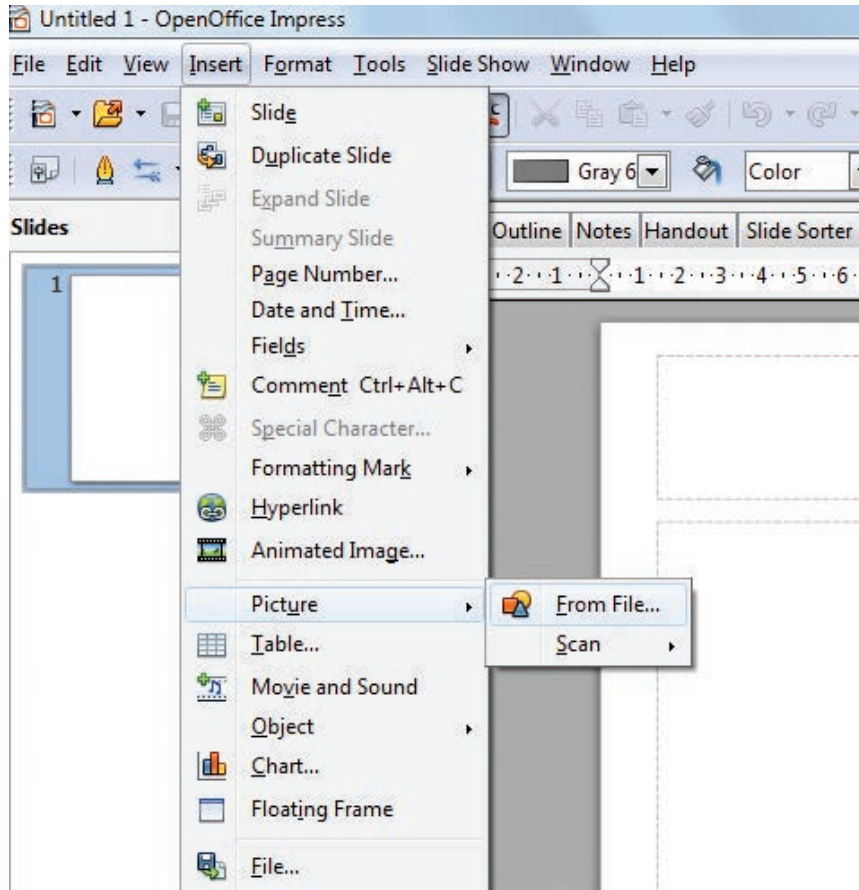

Figure 8.43 Inserting an image using insert menu

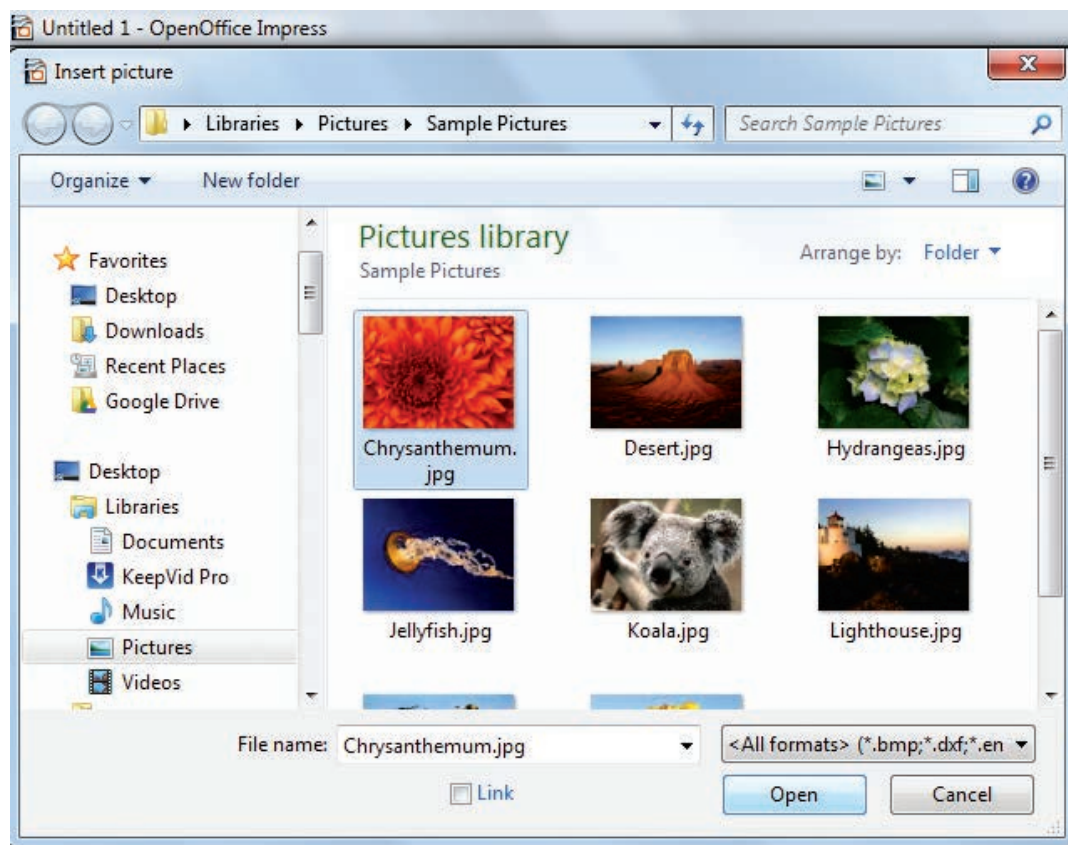

Figure 8.44 Selecting the image from a location

## 8.14 Inserting audio and video

Open Office Impress will let you insert audio files or movie files. The audio and movie files can be inserted by clicking **Insert Movie** and **Sounds** option from the **Insert** menu. Figure 8.45

Same as inserting images here also, a dialog box will be opened. Select the audio or movie file from the specified location and open. It will be opened in the slide. Figure 8.46. The movie or audio file inserted will be played during the slide show by clicking the mouse over it.

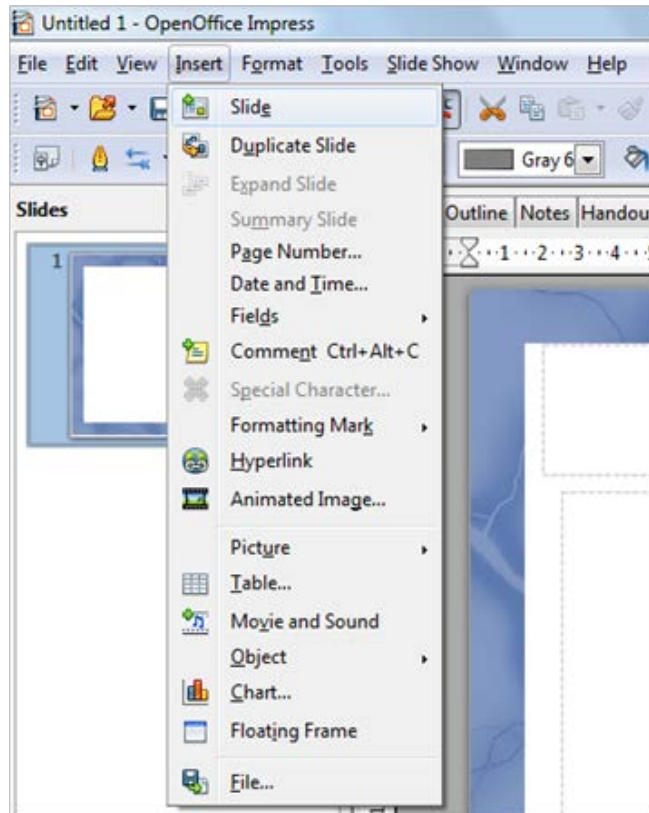

Figure 8.45 Inserting Movie and Sound

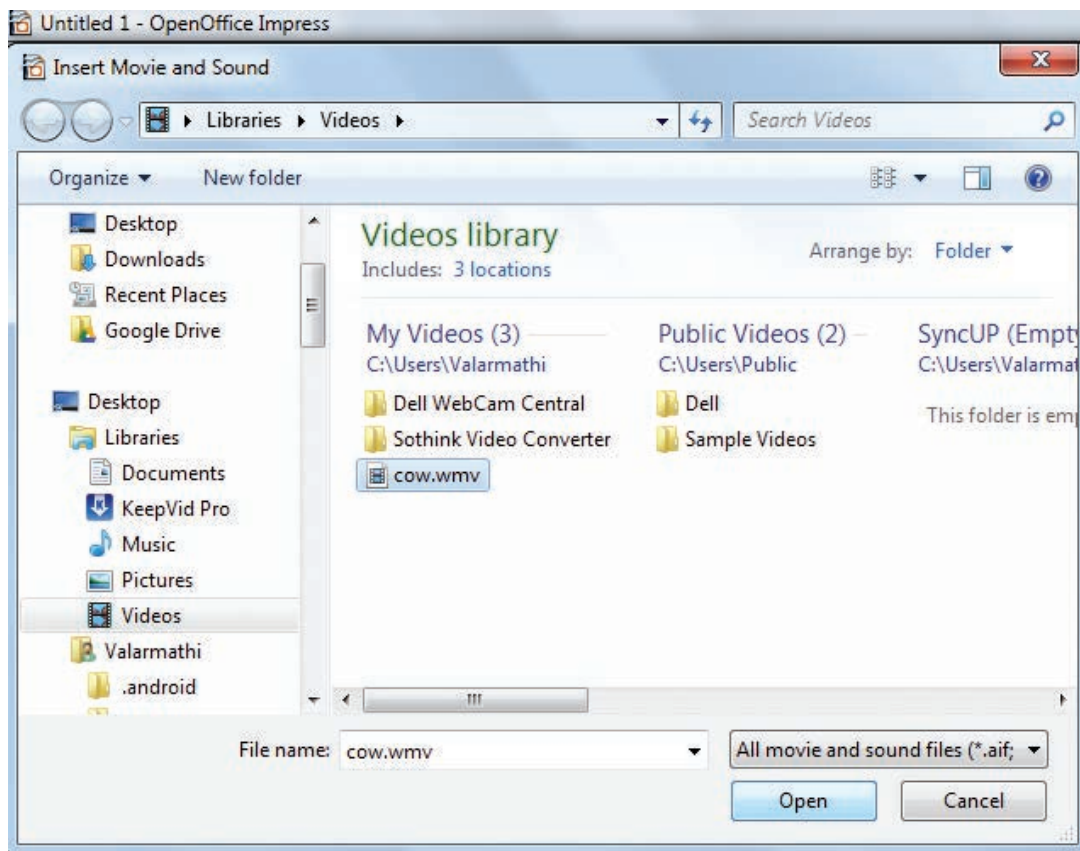

Figure 8.46 Selecting the Movie / Sound file

## Activity



### Student Activity

1. Create a presentation using
  - Empty presentation
  - Template
  - Open Existing Presentation
2. Create a presentation using MS PowerPoint.
3. Identify and write the differences between creating a presentation using Impress and MS PowerPoint.
4. Create a presentation of “My State” using all the types of slide layouts.
5. Run the slideshow of “My State” by fixing durations of time for each slide.

### Teacher Activity

This entire chapter can be taught with the help of the following methodology.

1. Laboratory Activity – the teacher can make the entire class to go to the lab and can explain the concept using a projector in the lab.
2. Or else, the teacher can demonstrate the concept using a PC and a projector inside the classroom.
3. The teacher apart from this Open source software, can compare the elements of the windows and creating presentations in MS PowerPoint also.

## Evaluation



### Part – I



#### Choose the correct answer

- Which is used to move quickly from one slide to another?  
A)Compass                      B)Navigator  
C)Fill color                      D)Page border
- Which is the shortcut key to view the slideshow?  
A)F6                      B)F9                      C)F5                      D)F10
- In Impress, which views shows thumbnail versions of all your slides arranged in horizontal rows.  
A)Notes                      B)Outline                      C)Handout                      D)Slide Sorter
- Identify the default view in Impress.  
A)Normal                      B)Slide Sorter                      C)Handout                      D)Notes
- Which menu contains the Slide Transition option?  
A)Slide Show                      B)View                      C)Tools                      D)Format
- Identify the extension of the Impress presentation.  
A) ,odp                      B) .ppt                      C) .odb                      d. ,ood
- In presentation tools, the entry effect as one slide replaces another slide in a slide show. Identify the option that suits after reading the statement.  
A)Animation                      B)Slide Transition  
C)Custom animation                      D)Rehearse Timing
- Vanya has made a presentation on “Global Warming”. She wants to progress her slide show automatically while speaks on the topic in the class. Which features of Impress would she use?  
A)Custom Animation                      B)Rehearse Timing  
C)Slide Transition                      D)Either (a) or (b).

### Part – II

#### Very Short Answers

- What is the difference between a slide and a slide show?
- How many in-built slide layouts does impress consist of?

3. What do you understand by a presentation?
4. Define a template in Impress.
5. What do you understand by the slide layout?

### Part-III

#### Short Answers

1. How many types of views are provided by Impress to its users?
2. Who uses the presentation software and why?
3. Define the Slide Sorter view and its significance.
4. What is a Normal view? Explain.
5. How are transition effects helpful in creating an effective presentation in Impress?

### Part-IV

#### Explain in Detail

1. Valarmathi's teacher asks her to create a presentation in OpenOffice Impress. As Valarmathi has never worked in Impress before, help her to perform the following tasks:
  - a. She wants that except for the first slide, all the slides should have the same design. For this, what does she need to do?
  - b. To easily communicate with her audience, she wants to provide them with a hard copy of the slides of the presentation. What should she create for it?
  - c. She wants to insert some pictures and movie files in some slides. How can she do that?
  - d. Suggest her the view that would be the most suitable for showing the presentation to the audience.
  - e. To make her presentation more attractive, she wants to add some effects in it. How can she do it? Suggest.
2. Explain how a presentation can help a salesperson to promote his/her products.
3. Sivabalan created a presentation to be shown at his school's Annual Function. Just 5 minutes before the presentation, he noticed that he has misspelt the name of the school, which is appearing in all the 30 slides of the presentation. How can he rectify this mistake in all the slides in one-shot?
4. List some advantages of using templates.

**Introduction to Internet and Email****Learning Objectives**

To know the

- Necessity of Internet in Commerce
- Types of Network available
- Services available in Internet
- Applications of Internet
- Difference between Internet, Intranet and extranet
- Difference between Webpage and Website
- Difference between Static and Dynamic Webpage
- Difference between Browser and Search engine
- Do's and don't of safe Surfing on Internet



Let us call this company Sri Mother International Ltd. Imagine the amount of information such as sales, inventory, etc. required by the management of the company to make everyday decisions. To get this information they will need to call their local offices. Their local offices will need to mail or fax printed reports or even send media (floppies!) through the postal service. By the time the mail is received, the data is already days old. Even if reports are faxed, it will be a cumbersome task to consolidate all reports. This task also increases chance of human error since large numbers of reports are manually collated. This is just one part of the equation. You also need to consider the information required by the local offices. They also need various data from the head office and other offices around the world.

Now consider the same company, but in the present time with all their offices interconnected. They would use a single application around the world that takes advantage of their global network. The data from all offices would be instantly stored at the central location and with a single click, the management team can see data from around the world in any format they like. This data would also be real-time. This means that they see it, as its happening. Since the data is centralized, any office location can see data pertaining to any location.

As you can see, the cost, time and effort involved in transferring data was

**9.1 Necessity of Internet**

It is important to understand what a network is and the importance of network. Simply put, a network is a collection of interconnected devices (such as computers, printers, etc.). To understand the importance of networks, let us look at how things worked before networks were created. For this, consider a large multinational company that sells food products in a time when networks did not exist.



much higher without networks. So networks decrease cost, time, and effort and thereby increase productivity. They also help in resource optimization by helping to share resources. A simple example of resource sharing is a printer, shared between many different computers in a typical office.

## 9.2 INTERNET and WWW

Several networks, small and big all over the world, are connected together to form a Global network called the internet. The internet uses TCP/IP (Transmission Control Protocol/ Internet Protocol ) to transmit data via various types of media. The internet protocol (IP) addressing system is used to keep track of the millions of users. Each computer on net is called as **host**. The internet is the most cost-effective method of communications in the world. Examples of few services available are:

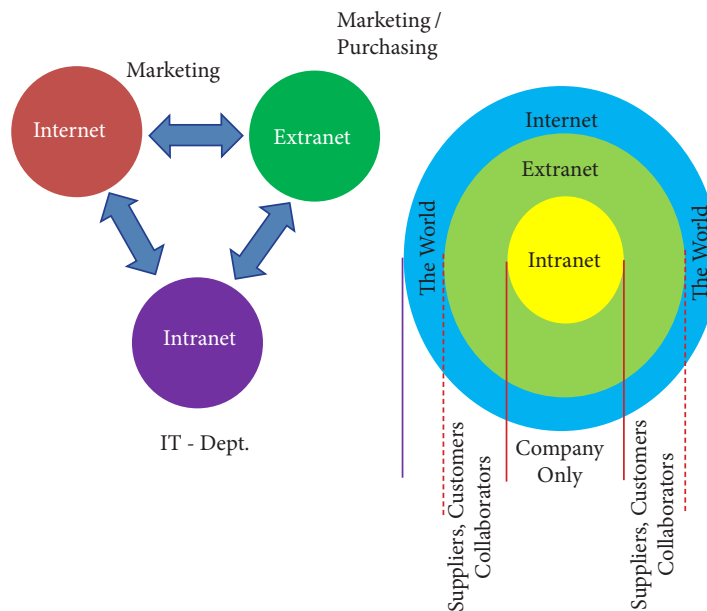

Figure 9.1

The **Internet** works by using a protocol called TCP/IP. TCP/IP allows one computer to talk to another computer via the Internet through compiling packets of data and sending them to right location.

An extranet is a private network that uses Internet technology and the public telecommunication system to securely share part of a business's information or operations with suppliers, vendors, partners, customers, or other businesses.

An Intranet is a website used by organizations to provide a place where employees can access company information (eg policies, procedures, staff, directory, department info), tools (quick links to common apps, forms etc.) and collaborate (to social sharing tools similar facebook).

- Email
- Web-enabled audio/video conferencing services
- Online movies and gaming
- Data transfer/file-sharing, often through File Transfer Protocol (FTP)
- Instant messaging
- Internet forums
- Social networking
- Online shopping
- Financial services

### 9.2.1 Domain Name

It is a name or an identity which become a online identity and can be access by the web browser when connected to internet.

Table: 9.1

Generic Domain Name	Description
.com	Commercial Organisation
.gov	Government institution
.org	Non-profit Organisation
.net	Network Support Group
.edu	Educational Institution



The heart of intranets and the internet is called as the **Domain Name System(DNS)**, the way computers can contact each other and do things such as exchange electronic mail or display Web pages. The Internet Protocol (IP) uses this Internet address information and the DNS to deliver mail and other information from computer to computer

Table: 9.2

Country Level Domain Name	Description
.in	India
.au	Australia
.us	United States of America
.jp	Japan
.ru	Russia
.sg	Singapore

### 9.2.2 What is URL?

Every server on the internet has an IP number, a unique number consisting of four parts separated by dots. The IP number is the server's address

165.113.245.2

128.143.22.55

At times the number keeps changing hence it is harder for people to remember number than to remember word combinations. So, addresses are given “word-based” addresses called URL. The URL and the IP number are one and the same.



Figure 9.2



A URL is an address that shows where a particular page can be found on the World Wide Web. URL is an abbreviation for '**Uniform Resource Locator (URL)**'.

### 9.2.3 Who Governs the Internet?

One of the most frequently asked questions about the internet is, “Who runs it?” The truth is that no centralized management of the internet exists.



ICANN was created on September 18, 1998, and incorporated on September 30, 1998, in the US State of California. It is headquartered in the Playa Vista neighborhood of Los Angeles.

The internet as a whole does not have a single controller. But the internet society, which is a voluntary membership organization, takes the responsibility to promote global information exchange through the internet technology. Internet Corporation for Assigned Names and Numbers( ICANN) administers the domain name registration. It helps to avoid a name which is already registered.

### 9.3.4 What is W3C?

W3C stands for "World Wide Web Consortium." The W3C is an international community that includes a full-time staff, industry experts, and several member organizations. These groups work together to develop standards for the World Wide Web.

The World Wide Web Consortium (W3C) is an international organization committed to improving the web. It is made up of several hundred member organizations from a variety of related IT industries. W3C sets standards for the World Wide Web (WWW) to facilitate better communication ability and cooperation among all web stakeholders. It was established in 1994 by the **creator of the WWW**, Tim Berners-Lee.

### 9.3 Types of Internet Service

Here are some common types of Internet service.

#### **Wireless**

Radio frequency bands are used in place of telephone or cable networks. One of the greatest advantages of wireless Internet connections is the "always-on" connection that can be accessed from any location that falls within network coverage. Wireless connections are made possible through the use of a modem, which picks up Internet signals and sends them to other devices.

#### **Mobile**

Many cell phone and smartphone providers offer voice plans with Internet access. Mobile Internet connections provide good speeds and allow you to access the Internet.

#### **Hotspots**

Hotspots are sites that offer Internet access over a wireless local area network (WLAN) by way of a router that then connects to an Internet service provider. Hotspots utilize Wi-Fi technology, which allows electronic devices to connect to the Internet or exchange data wirelessly through radio waves. Hotspots can be phone-based or free-standing, commercial or free to the public.

#### **Broadband**

This high-speed Internet connection is provided through either cable or telephone companies. One of the fastest options available, broadband Internet uses multiple data channels to send large quantities of information. The term broadband is shorthand for broad bandwidth. Broadband Internet connections such as DSL and cable are considered high-bandwidth connections. Although many DSL connections can be considered broadband, not all broadband connections are DSL.

#### **DSL**

DSL, which stands for Digital Subscriber Line, uses existing 2-wire copper telephone line connected to one's home so service is delivered at the same time as landline telephone service. Customers can still place calls while surfing the Internet.

#### **Cable**

Cable Internet connection is a form of broadband access. Through use of a cable modem, users can access the Internet over cable TV lines. Cable modems can provide extremely fast access to the Internet.

#### **Satellite**

In certain areas where broadband connection is not yet offered, a satellite Internet option may be available. Similar to wireless access, satellite connection utilizes a modem.

#### **ISDN**

ISDN (Integrated Services Digital Network) allows users to send data, voice and video content over digital telephone lines or standard telephone wires. The installation of an ISDN adapter is required at both ends of the transmission—on the part of the user as well as the Internet access provider.

## Dongles / Data Card

Today, many dongles provide wireless capabilities. For example, USB Wi-Fi adapters are often called dongles. Since most computers now have built-in Wi-Fi chips, mobile data adapters, such as 3G and 4G dongles, are more prevalent. These types of dongles allow to connect to the Internet even when Wi-Fi is not available.

### Comparison between Data Card and Dongle

Dongle	Data Card
Refers to any removable component used for enabling extra security. USB Dongles can be divided into <ul style="list-style-type: none"> <li>• WiFi Dongles</li> <li>• Bluetooth Dongle</li> <li>• Memory Dongle</li> </ul>	It is a removable electronic card which is used for storing data. Types of datacard are <ul style="list-style-type: none"> <li>• Expansion Card</li> <li>• Memory Card or Flash Card</li> <li>• Identification Card</li> </ul>

### 9.3.1 Internet Connection and Access Methods

There are several ways or methods of connecting to the Internet.

There are two access methods direct and Indirect and these can be either fixed or mobile.

#### 9.3.1.1 Indirect Access

This is most common method used in home and office networks.

The device e.g. computer connects to a network using Ethernet or WiFi and the network connects to the Internet using Asymmetric digital subscriber line ADSL (cable or fibre.)

#### 9.3.1.2 Direct Access

This is most common method used when travelling.

The device e.g. smart phone connects directly to the Internet using 3G/4G mobile networks or public Wi-Fi.

There are two ways to look for the information on the web.

1. If the URL of the website is known, enter it on the address bar.
2. If the URL is not known, then "Search Engines" will help us to get the information.

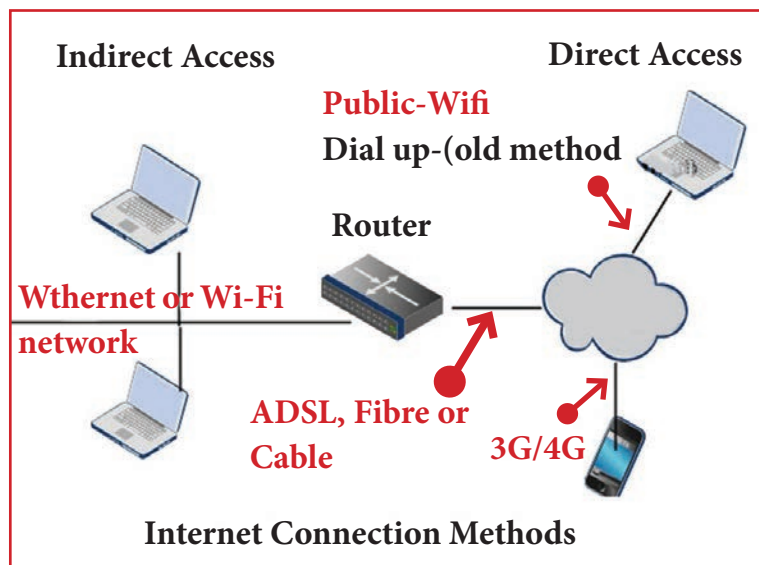

Figure 9.3

A search engine is a software system that is designed to search for information on the World Wide Web.

Examples of popular search engines are Yahoo, Lycos, Altavista, Hotbot, Google and Askjeeves.

1. A browser is used to access websites and web pages whereas a search engine is used to search for particular information.
2. Internet Explorer, Chrome, Firefox, Safari, and are the most popular web browsers while Google and Yahoo are the most popular search engines.
3. A browser is used to access the Internet whereas in order to open a search engine you need a browser.

The list of content returned via a search engine to a user is known as a search engine results page (SERP).

### 9.4 Internet Applications

#### 1. Internet telephony using VoIP (Voice-over-Internet Protocol) Example Skype

**2. Job search** :- Nowadays, many people search for their jobs online using naukri.com, monster.com, recruitmentindia.com etc as it is quicker .

**3. Online Shopping** :- The internet has also facilitated the introduction of a new market concept consisting of virtual shops. For example amazon.com

**4. Stock market updates** :- Selling or buying shares sitting on computer through internet. Several websites like ndtvprofit.com, moneypore.com, provide information regarding investment

**5. Travel** :- One can use internet to gather information about various tourist place .it can be used for booking Holiday tours. Some of the web sites providing this service are goibibo.com, makemytrip.com, olacabs.com.

**6. Research** :- Research papers are present online which helps in the researcher doing a literature review

**7. Video conferencing** :- It enables direct face-to-face communication across networks via web cameras, microphones, and other communication tools.

**8. e-commerce** :- e-commerce (electronic commerce or EC) is the buying and selling of goods and services, or the transmitting of funds or data, Largest e-commerce companies in India are Flipkart, Snapdeal, Amazon India, Paytm.

**9. Online payments** :- The rising boom of online payments in India has given way to many new entrants in the industry such as Paytm etc who are majorly wallet driven payment companies.

- 10. Social Networking** :- Social networking is the use of internet-based social media programs to make connections with friends, family etc. Examples of social networking includes Facebook
- 11. Voicemail** :-Voicemail is a system of sending messages over the phone.
- 12. Chatting** :-On the Internet, chatting is talking to other people who are using the Internet at the same time you are.
- 13. e-banking** :-e-banking (Online banking) , also known as internet banking, it is an electronic payment system that enables customers of a bank or other financial institution to conduct a range of financial transactions through the financial institution's website. The online banking system will typically connect to or be part of the core banking system operated by a bank and is in contrast to branch banking which was the traditional way customers accessed banking services.
- 14. e-learning** :-e-Learning are courses that are specifically delivered via the internet to somewhere other than the classroom where the professor is teaching. It is not a course delivered via a DVD or CD-ROM, video tape or over a television channel

e-learning is utilizing electronic technologies to access educational curriculum outside of a traditional classroom. It is a program delivered completely online. E-learning is interactive in that you can also communicate with teachers, professors or other students in a class. There is always a teacher/ professor interacting/ communicating, grading participation, giving assignments and conducting tests.

**15. E-governance** :- Electronic governance or e-governance is the application of information and communication technology (ICT) for delivering government services.

### Benefits of E-governance

- Reduced corruption
- High transparency
- Increased convenience
- Reduction in overall cost.
- Expanded reach of government

### 9.5 Email

Electronic mail or email is information stored on a computer that is exchanged between two users over telecommunications. Email is a message that may contain text, files, images or any other attachments sent through a network to a specified individual or group of individuals

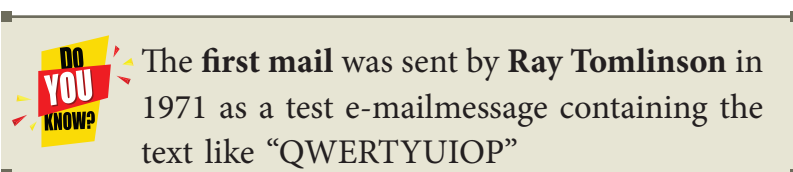

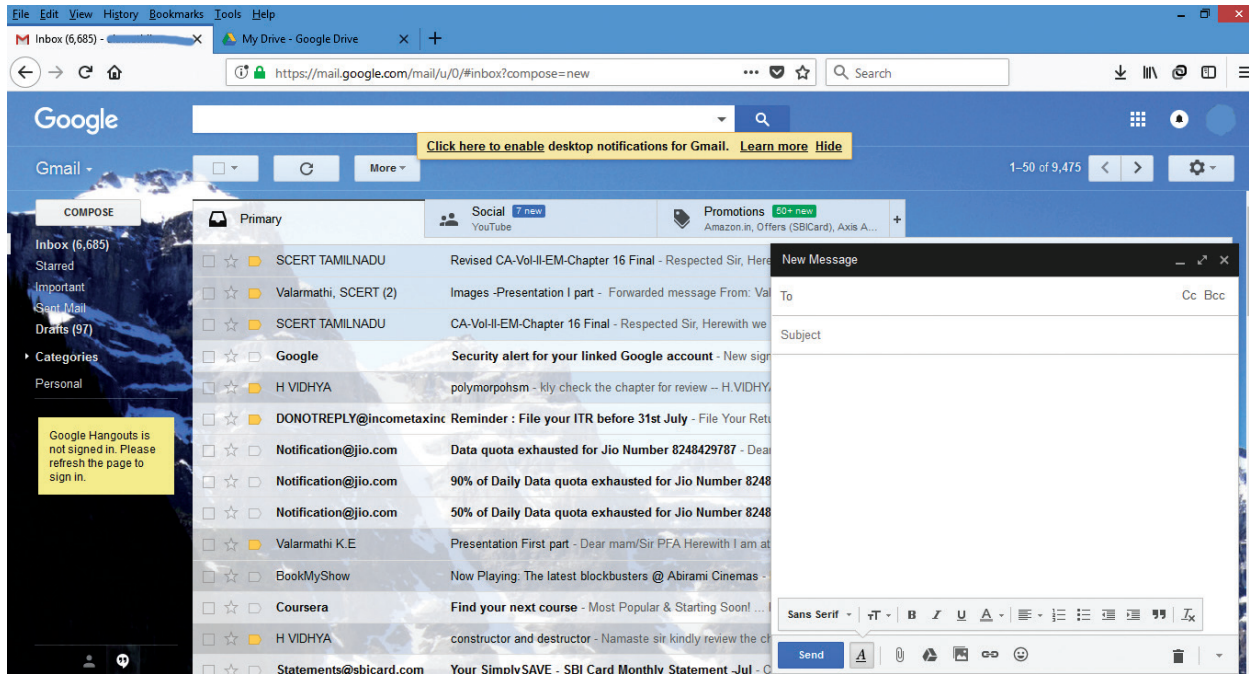

Figure 9.4

### 9.5.1 Structure of email

Click the **Compose** button and then writing an e-mail contents

**When sending an e-mail message, several fields are required to be filled:**

- The **To** field is where you type the e-mail address of the person who is the recipient of your message.
- The **From** field should contain your e-mail address.
- If you are replying to a message, the To and From fields are automatically filled out; if it's a new message, you'll need to enter them manually.
- The **Subject** should consist of a few words describing the e-mail's contents. The Subject lets the recipient see what the e-mail is about, without opening and reading the full e-mail. This field is optional.
- The **CC (Carbon Copy)** field allows you to specify recipients who are not direct addressees (listed in the "To" field). This field is optional.
- The **BCC (Blind Carbon Copy)** field is similar to CC, except the recipients are secret. Each BCC recipient will receive the e-mail, but will not see who else received a copy. The addressees (anyone listed in the "To" field) remain visible to all recipients. This field is optional.
- Finally, the **Message Body** is the location you type your main message. It often contains your signature at the bottom; similar to a hand-written letter.

### 9.5.2 Advantages of email

Some of the main advantages of email are listed below.



- **Free delivery** - Sending an e-mail is virtually free, outside the cost of Internet service. There is no need to buy a postage stamp to send a letter.
- **Global delivery** - E-mail can be sent to nearly anywhere around the world, to any country.
- **Instant delivery** - An e-mail can be instantly sent and received by the recipient over the Internet.
- **File attachment** - An e-mail can include one or more file attachments, allowing a person to send documents, pictures, or other files with an e-mail.
- **Long-term storage** - E-mails are stored electronically, which allows for storage and archival over long periods of time.
- **Environmentally friendly** - Sending an e-mail does not require paper ( Paperless ), cardboard, or packing tape, conserving paper resources.

### 9.5.3 What is sent in an email

In addition to text messages being sent over e-mail, it is also possible to attach a file or other data in an e-mail. For example, an attachment could be a picture, PDF, word processor document, or any file stored on the computer.

## 9.6 Internet Threat

It's a dangerous world out there in the World Wide Web. Just as your mother may have told you to never talk to strangers, the same advice holds true for the virtual world. You may know to be wary of giving strangers your business bank account details. But can you be sure the website you're logging into is that of your bank and not a forgery created by a cybercriminal? Cybercriminals use many different methods to lure you into parting with your confidential personal or business information. Hence you ought to be aware of the issues and be extra vigilant when online and offline..

**Computer virus:** A computer virus is a small piece of software that can spread from one infected computer to another. The virus could corrupt, steal, or delete data on your computer—

**Malware:** Malware is short for “malicious software.” Malware is used to mean a “variety of forms of hostile, intrusive, or annoying software or program code.” Malware could be computer viruses, worms, Trojan horses, dishonest spyware, and malicious rootkits—all of which are defined below.

**Trojan horse:** Users can infect their computers with Trojan horse software simply by downloading an application they thought was legitimate but was in fact malicious.

**Malicious spyware:** Malicious spyware is used to describe the Trojan application that was created by cybercriminals to spy on their victims.

**Computer worm:** A computer worm is a software program that can copy itself from one computer to another, without human interaction.

**Botnet:** A botnet is a group of computers connected to the Internet that have been compromised by a hacker using a computer virus or Trojan horse. An individual computer in the group is known as a “zombie” computer.

**Spam:** Spam in the security context is primarily used to describe email spam. Unwanted

messages in your email inbox. Spam, or electronic junk mail, is a nuisance as it can clutter your mailbox as well as potentially take up space on your mail server.

**Phishing:** Phishing scams are fraudulent attempts by cybercriminals to obtain private information. Phishing scams often appear in the guise of email messages designed to appear as though they are from legitimate sources. For example, the message would try to lure you into giving your personal information by pretending that your bank or email service provider is updating its website and that you must click on the link in the email to verify your account information and password details.

**Rootkit:** A rootkit is a collection of tools that are used to obtain administrator-level access to a computer or a network of computers. A rootkit could be installed on your computer by a cybercriminal exploiting a vulnerability or security hole in a legitimate application on your PC and may contain spyware that monitors and records keystrokes.

### 9.7. Browsers

Looking for information on the internet is called **surfing or browsing**. To browse the internet, a software called the **web browser or browser** is used.

E-commerce, social media, and many other things we take for granted today would be impossible without internet browsers. Web browsers translates HTML documents of the website and allows to view it on the screen.

#### 9.8.1 Familiar Internet Browser

1. **Google Chrome** is a freeware familiar web browser **developed by Google Inc.** It is best for its speed, simplicity, security, privacy and customization features. Google Chrome supports on Android 4.0 or higher, iOS 6.0 or higher, Mac OSX 10.6 or higher and Windows (XP sp2 or higher) and Linux system.
2. **Mozilla Firefox** is a free and open source web browser **developed by Mozilla Foundation and Mozilla Corporation.** FireFox is **default browser in Ubuntu** . It supports Windows, Mac OS X, Linux and Android system.
3. **Internet Explorer** commonly known as Microsoft Internet Explorer or Windows Internet Explorer is the first or default browser for a Windows PC. It is **developed by Microsoft.**
4. **Safari** is a web browser **developed by Apple Inc.** and comes with OS X and iOS. Some version of safari browser also supports in Windows Operating System. **Exclusively used in Apple Mac system.**

### 9.8 Web Page Vs Web Site

#### Websites

A website is a collection of webpages. For example if there is a company that owns sricompany.com then this website will have several Webpages like Home, About Us, Contact Us, Testimonials, Products, Services, FAQ's, and others. The first page of the website is called a Home Page. All of these pages together make up a Website.

## Web Pages

A webpage is a page of a Website. A web page can be accessed by a URL in a browser and that page can be copied and or send to a friend for review whereas websites are collections of multiple page that must be navigated to view other content

A webpage is a page of a Website. Every page has a unique address called the Uniform Resource Locator (URL). The URL locates the pages on the internet.

### Difference between Webpage and Website

Webpage	Website
Consists of a Single document displayed by a browser	A collection of multiple documents displayable by a browser
Shares a unique domain name	Has its own unique domain name
Makes up a website	Contains one or more webpages

### 9.9 Static and Dynamic Web Pages

Web pages are classified as Static and Dynamic Webpages

Web pages are called Static websites as they remain the same whenever it is visited. Examples of static Websites are website owned by Small business organizations, School websites etc.

Websites that displays marks of Public Examinations and Entrance Examinations changes when different register numbers are given. Such websites are called as Dynamic Websites. Eg., Websites of Government and Entrance Exams.

### Comparison of Static and Dynamic Web Pages

Static Web Page	Dynamic Web Page
The content and layout of a web page is fixed	The content and layout may change during run time
Static Web pages never use databases	Databases is used to generate dynamic content through queries
Static web pages directly run on the browser and do not require any server side application program	Dynamic web pages runs on the server side application programs and displays the results
Static Web pages are easy to develop	Dynamic web page development requires programming skills

### 9.10 Safe Surfing on Internet

As a great reminder that Internet security is something that needs constant vigilance. It's also a great reminder that a lot of things can happen on the Internet if you don't properly take precautions against them. With that in mind, be sure to have a safe and happy Safer Internet Day.

## SAFER INTERNET DAY

Safer Internet Day (SID) 2018 is celebrated around the world in February of every year with a theme of "Create, connect and share respect: A better internet starts with you".

### Following is the do's and don't of safe Surfing on Internet

1. Don't give out your personal information – Don't put personal details such as your home address, telephone numbers or parent's work address online as cybercriminals can use this information to create a fake profile with your details
2. What goes online, stays online – Use privacy settings to make sure only your friends and family can see photos you post. Avoid posting holiday plans as criminals have been known to track your movements
3. Check your security and privacy settings – Make sure your social network privacy settings are secured so only your friends can see your personal information and use your privacy settings to restrict who can see your posts, videos and photos
4. Password safety – Sharing your password with your parents is a sensible idea, but avoid sharing your password with your friends, even if they promise they won't tell anyone! Also, when setting your password, make sure it isn't something people may guess such as your pet's name. Use a mixture of letters, numbers and upper and lower case characters
5. Always protect your mobile device – Make sure your mobile phone is pin-protected so all your personal information stored on it is safe. Download a security app which allows you to remotely wipe any personal data, should your mobile be lost or stolen
6. Don't talk to strangers online or offline – Don't meet up with strangers and let your parents know if a stranger has tried to get in contact with you online.
7. Listen to the adults who know – Adults will always be worried about you. Help set their mind at rest and avoid chatting online with strangers.
8. Be wary of unsecured or unknown websites – When shopping online, use reputable and known retailers.
9. Be careful what links you click on – Avoid clicking links in an email, Instant Message or on your social network unless you are sure the message is from someone you know.

Now that we have come to the end of this chapter, the next chapter introduces you to create a web page using html tags.

### Points to Remember:

- The different type of network are LAN, MAN, WAN, PAN, CAN and WLAN
- Two things required for TCP/IP needed are
  - a) Message to transmit
  - b) Means to reliably transmit the message
- Each computer on net is called as host
- Internet Corporation for Assigned Names and Numbers ( ICANN) administers the domain registration to avoid name already registered.
- W3C stands for world wide web consortium.
- Hotspots are sites that offer internet access over wireless local network.
- Video conferencing enables direct face-to-face communication across networks via web cameras, microphones, and other communication tools.
- E-commerce (electronic commerce or EC) is the buying and selling of goods and services, or the transmitting of funds or data, over an electronic network, primarily the Internet.
- Social networking is the use of internet-based social media programs to make connections with friends, family, classmates, customers and clients.
- Voicemail is a system of sending messages over the phone.
- Email is short for 'electronic mail' similar to a letter, it is sent via the internet to a recipient
- An internet browser, also known as a web browser, is a software program that you can use to access the internet and view web pages on your computer.
- A website is a collection of webpages.
- Dongle refers to removable component used for enabling software protection. E.g. USB, WiFi
- A webpage is a page of a Website.
- E-commerce is the activity of buying or selling of products on online services or over the Internet.
- Electronic governance or e-governance is the application of information and communication technology (ICT) for delivering government services.

## Evaluation



### Part – I

#### Choose the correct answer

1. What is the expansion of WLAN?
 

a) Wireless Local Area Network	b) Wired local Area Network
c) Wireless Local Area Netware	d) Wireless Area Netbande
  
2. Range of Campus Network is
 

a) 10 KM	b) 5 KM	c) 25 KM	d) 20 KM
----------	---------	----------	----------
  
3. Each computer on net is called
 

a) host	b) server	c) workstation	d) node
---------	-----------	----------------	---------
  
4. The internet is governed by
 

a) ICANM	b) ICANN	c) ICMA	d) ICNNA
----------	----------	---------	----------
  
5. Expansion of W3C
 

a) World Wide Web Consortium	b) Wide World Web Consortium
c) World Web Wide Consortium	d) World Wide Web Consortum
  
6. W3C was established in 1994 by
 

a) Tim Berners-Lee	b) Tim Burnard Lee
c) Kim Berners	d) Kim Bernard Lee
  
7. Hotspot uses which type of network services?
 

a) LAN	b) PAN	c) WLAN	d) CAN
--------	--------	---------	--------
  
8. USB WiFi adapters are often called as
 

a) Data Card	b) Pen Drive	c) Dongles	d) Memory Card
--------------	--------------	------------	----------------
  
9. Looking for information on the internet is called
 

a) Surfing	b) Searching	c) Finding	d) glancing
------------	--------------	------------	-------------
  
10. Safari web browser was developed by
 

a) Google	b) Apple	c) Microsoft	d) Linux Corpn.
-----------	----------	--------------	-----------------
  
11. How many types of websites are available?
 

a) 3	b) 2	c) 4	d) 6
------	------	------	------

**Part – II****Very Short Answers**

1. Name the two important protocols for internet?
2. What is a network?
3. What is the role of ICANN ?
4. What is a search engine?
5. What is a browser?
6. What are the components of url addressing ?
7. What is a website?
8. What is CC and BCC in an email?
9. What is a Static web Page?
10. What is a Dynamic web page?
11. What are the benefits of e-governance?
12. What is Phishing ?

**Part-III****Short Answers**

1. What is TCP/IP ?
2. Write a note on Hotspot internet service.

3. Differentiate Data Card and Dongles.
4. Write a note on two access methods of connecting to internet.
5. Differentiate browser and a search engine with suitable examples.
6. Differentiate Website and Webpage.
7. What is the difference between Static and dynamic web page.
8. What are Advantages of email.

**Part-IV****Explain in Detail**

1. Explain any five types of internet services.
2. Explain any five internet applications with suitable examples.
3. Write a note on any five Internet browsers other than that given in the book.
4. Explain the do's and don't of safe surfing on internet.

**Activity****Student Activity**

Explain the different types of network.

Mention a few internet services you know.

Mention a few Internet Applications other than that is given in the textbook

List some browsers not given in the text book

**Teacher Activity**

Students is taught to develop Static and Dynamic Websites as workshop.

**GLOSSARY**

<b>Acronym</b>	<b>Description</b>
<i>VSNL</i>	<i>Videsh Sanchar Nigam Ltd</i>
<i>TCP</i>	<i>Transmission Control Protocol</i>
<i>IP</i>	<i>Internet Protocol</i>
<i>Host</i>	<i>A host is a computer connected to a computer network</i>

ICANN	<i>Internet Corporation for Assigned Names and Numbers</i>
W3C	<i>World Wide Web Consortium</i>
WWW	<i>World Wide Web</i>
<i>Tim Berners-Lee</i>	<i>Creator of WWW</i>
DSL	<i>Digital Subscriber Line</i>
ISDN	<i>Integrated Services Digital Network</i>
URL	<i>Uniform Resource Locator</i>
Dongle	<i>A small device able to be connected to and used with a computer, allowing access to wireless broadband or use of protected software.</i>
ADSL	<i>Asymmetric Digital Subscriber Line</i>
Browser	<i>A browser is software that is used to access the internet Eg. Chrome, FireFox</i>
Search Engine	<i>A search engine is a web-based tool that enables users to locate information on WWW. Eg. Google</i>
SERP.	<i>The list of content returned via a search engine to a user is known as a search engine results page.</i>
Phishing	<i>Phishing scams are fraudulent attempts by cybercriminals to obtain private information</i>
WebSite	<i>Collection of Webpages</i>
WebPage	<i>It is page of Website.</i>
EDI	<i>Electronic Data Interchange</i>
Voice mail	<i>System of sending messages over the phone.</i>
e-commerce	<i>Electronic Commerce, Buying and selling goods and services over an electronic network.</i>
e-governance	<i>Electronic governance. Application of information and communication technology for delivering government services.</i>
Internet	<i>Several networks, small and big all over the world, are connected together to form a Global network called the internet.</i>
Intranet	<i>It is a website used by organizations to provide a place where employees can access company related information.</i>
Extranet	<i>It is a private network using internet technology to share part of business information with suppliers partners and customers.</i>

## References:

1. Mastering HTML, CSS & JavaScript Web Publishing – Laura Lemay, Rafe Colburn, Jennifer Kyrnin – BPB Publications.





### Learning Objectives:

The students will learn the following:

- How to create web pages using HTML.
- What are the various structural tags available to create an HTML document.
- What are the various page formatting tags available and how to use them.

#### 10.1 Introduction to HTML

In the previous sections you learnt about Internet and web pages, whatever you have seen on the web is a document written in **HTML (Hyper Text Markup Language)**. HTML is a special markup language used to create web pages. This language tells the browsers, how to display the text, images, animations and other contents of a hypertext document on the screen. The language also tells how to make a document interactive through special hyper links.

HTML is not a word processing tool or a programming language. It is only a markup or page layout and hyperlink specification language. It describes the structure of a document.

### HTML - Structural Tags

**DO YOU KNOW?** HTML was originally derived from SGML (Standard Generalized Markup Language) a larger, complicated document processing language. To learn HTML, no need to know about SGML.

#### 10.2 Writing HTML document

HTML is a markup language. Writing in a markup language is very simple, directly you start the text of your web document and add special tags around words and paragraphs. The tags are coded by HTML commands or keywords that indicate how web browser should format and display the content.

HTML is made up of tags and its attributes. Tags are known as elements of HTML. Additional information such as colour, alignment etc., can be included with an HTML tag known as attribute. Attributes are used to improve the appearance of an HTML document. You cannot create your own tags to create a new style or feature.

All HTML tags should be specified within angle brackets (< >). For example, <HTML> is a tag. HTML is not case sensitive that means you can write an HTML tag in lower case or in upper case (Small letter or Capital letter). Browser treats both of them in the same manner. For example, you can write <HTML> as <html>; both are same.

### 10.2.1 HTML Document Structure

An HTML document contains the text of the page itself and HTML tags, which defined the structure and appearance of the document. It also contains hyperlinks to other pages or to include multimedia elements such as audio, video, animations etc. Entire HTML document is bounded within a pair of <html> and </html> tags.

#### All HTML documents should follow this general format

```
<html>
<head>
  <title> My First Web Page </title>
</head>
<body>
  This is my First Web Page
</body>
</html>
```

HTML tags are generally have an opening and closing tag surrounding the text they affect. Opening tag turn-on a feature such as heading, bold, center etc., and closing tag turn-off its features. Opening and closing tags are the same name, but closing tag name preceded by a slash ( / ). For example, <html> is an opening tag, </html> is a closing tag.

Every web document has two sections viz. **Heading Section** and **Body Section**. The heading section is used to show the title of a webpage in title bar or tab heading in browser. The head section should begins with <head> tag and end with </head> tag. The tag <title> is used to specify the title of the webpage.

The body section is used to display the main content on the browser window. The body section should defined within <body> and </body> tags. Whatever the text you specify between these tags will display on the browser window. (Refer Figure 10.1)

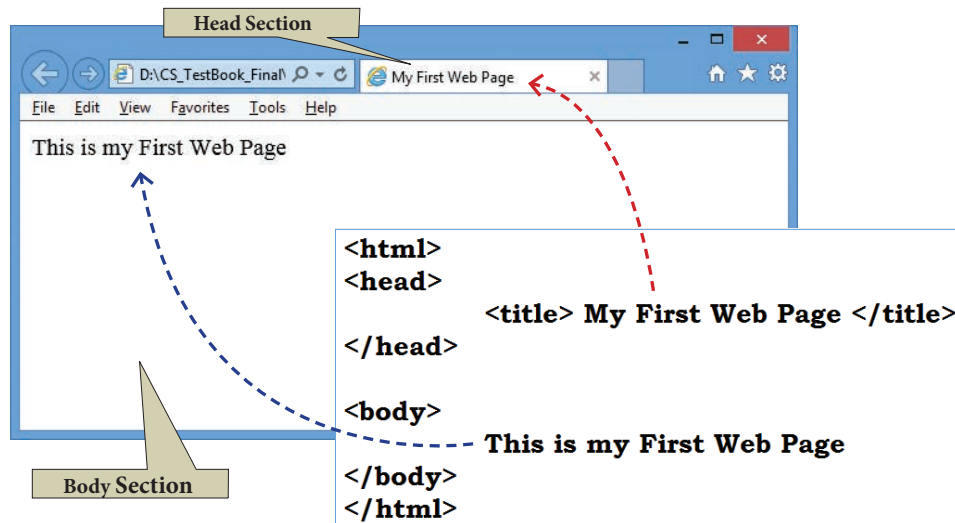

Figure 10.1 – Internet Explorer with my first web page

### 10.2.2. Structural Tags of HTML:

<html>, <head>, <title> and <body> these four tags are known as structural tags. These tags are basic essential elements to construct a web page.

Table: 10.1

Opening Tag	Closing Tag	Description
<html>	</html>	The <html> tag identified the document as an HTML document. All HTML documents should begins with <html> and end with </html>.
<head>	</head>	The <head> tag contains information about the document, including its title, scripts used, style definition and document descriptions.
<title>	</title>	The <title> tag contains the title of the document. The title specified between opening and closing tags appears in the title bar / page tab of the browser. <title> tag should be placed within <head> tag.
<body>	</body>	The <body> tag encloses all the tags, attributes and information to be displayed in the web page. <body> tag should be entered below the </head> tag.

### 10.2.3. HTML Writing Tools

To get started writing HTML, there is no need of web server, web hosting or even internet connection. You can write, test and link web pages without a network. To create and testing a HTML document i.e. web page need an application (text editor) to write HTML code and a browser to view them. Using a simple text editor (Notepad for Windows or getit for Linux) is a good way to learn HTML coding.

### 10.2.3.1 Creating a Webpage

#### Step 1: Open a text editor

Windows7 : Start → All Programs  
→ Accessories → Notepad

**Step 2:** In the appearing Note pad / Text Editor, type the HTML document.

(Refer Figure 10.2)

#### Step 3: Save the file as HTML

- Click File → Save (or) Press Ctrl + S
- Save as dialog box appears as shown in the Figure 10.3
- In “File Name” text box, type a file name with .htm or .html extension.
- Select “All Files” from “Save as type” list box.
- Click “Save” button.

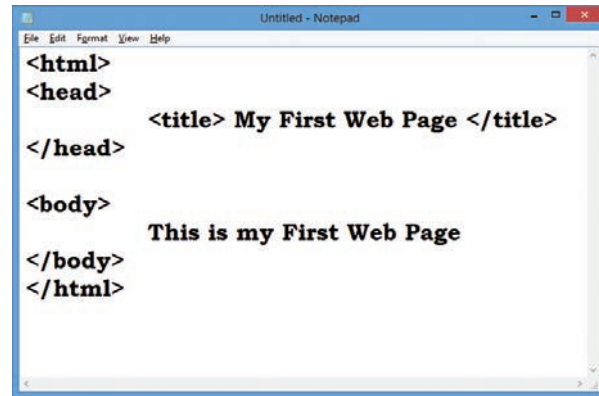

Figure 10.2 – Notepad with HTML code

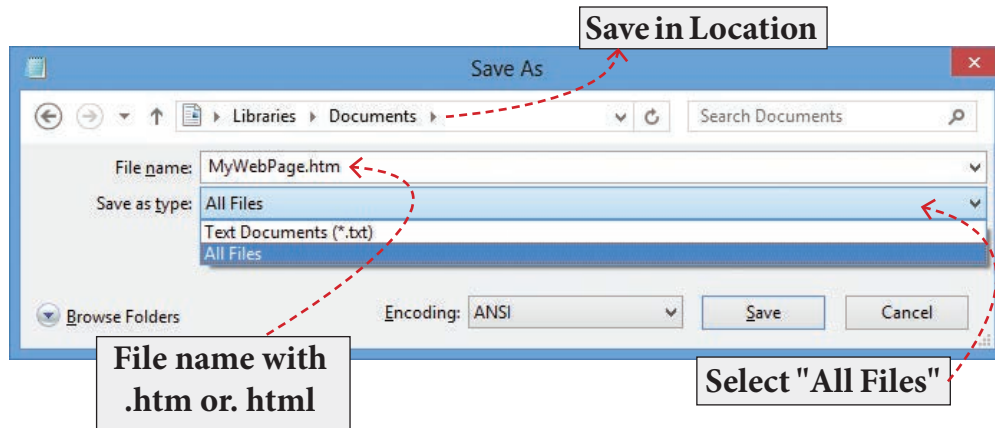

Figure 10.3 Save As dialog box

### 10.2.3.2. Viewing Webpage in a Browser:

**Step 1: Open a Browser** (Internet Explorer / Mozilla Firefox or any)

**Step 2:** Click **File** → **Open File** (or) Press **Ctrl + O**

**Step 3:** From the “Open” dialog box, browse the folder in which the HTML document is saved. Choose the File name and click “Open” button. (Refer Figure 10.5)

Now, your web page is displayed in the browser.

### 10.2.3.3 Viewing Source file

Source file is an HTML document, what you actually type in text editor (Notepad or getit). You can view your original source file in the browser. The following steps are to be followed to view a source file.

- Right click on the browser
- Select **View Page Source (Firefox and Chrome)** / **View Source (Internet Explorer)** or Press **Ctrl + U** (all browser)
- Source file will be displayed.

- In Internet Explorer, **View** → **Source** is also used to open source file. Remember that, you cannot edit the source file opened using the methods you learnt above.

#### 10.2.3.4 Edit and Reload the source file

Source file can be edit only through the text editor. So, to edit the source file, open the source file with a text editor. **When you edit a source file, no need to close browser in which displaying the HTML document.** The following steps are to be followed to open a source file.

- Go to the folder in which your source files are located.
- According to you default browser, your source file icon is displayed. (Refer Figure 10.7)

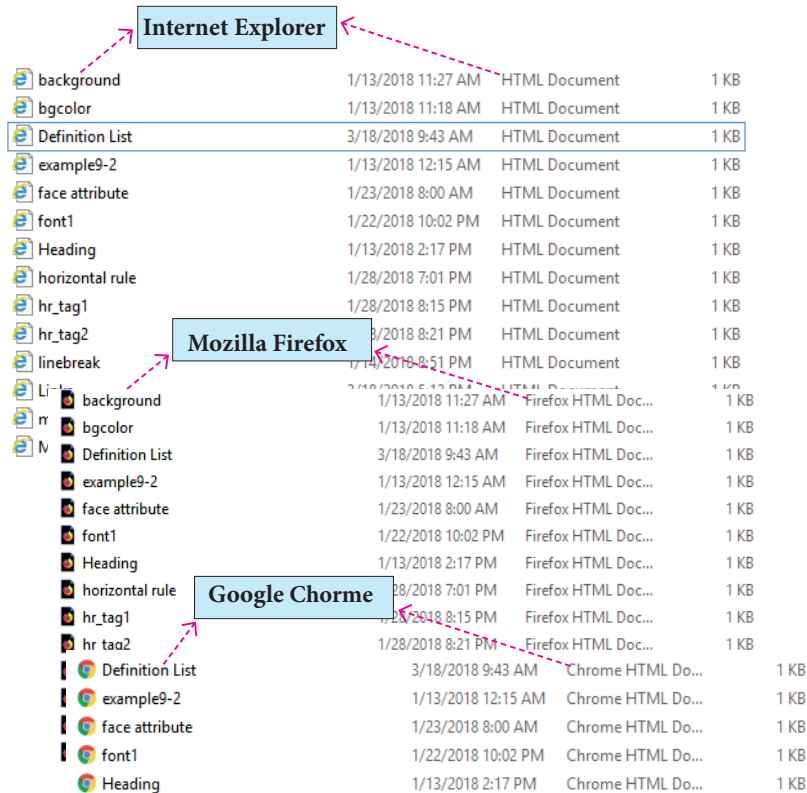

Figure 10.5 Source files in different browsers

- Right click on the source file that you want to edit
- From the pop-up menu, select **Open With** → **Notepad**
- Source file will be opened in text editor
- Make the changes and save the file using **File** → **Save** or **Ctrl + S**.

#### Reload / Refresh the changes:

- After modify and save the source file, minimize your source file.
- Go to the browser.
- Click **Refresh** (Internet Explorer) / **Reload Current Page** (Firefox) / **Reload this page** (Chrome) icons on the address bar.
- Press **Ctrl + R** or **F5** will be used to refresh / reload the modifications.

### 10.3 HTML Attributes

Attributes are special words used inside a tag to specify additional information to a tag. Attributes should be placed within the opening tag. Most of the tags support specialized attributes and there are also a few global elements that can be used with any tag. Global elements are common to all HTML elements; they can be used on all elements.

#### 10.3.1 Attributes for Structural Tags

##### 1. Attributes of <html> tag

The <html> tag is used to specify the beginning and closing of an HTML document. This tag does not have any effect on appearance of document. This is only used to make browsers and other programs, known that this is an HTML document.

<html> tag has two attributes viz. **dir** and **lang** to specify the **text direction** and **language setting** respectively.

attribute	Value to be set to attribute	Description
dir	ltr (align left-to-right) rtl (align right-to-left)	dir attribute specifies the direction of the text to be aligned within the entire document. It is global attribute. <ul style="list-style-type: none"> <li>• ltr is the default value</li> <li>• rtl is used for Arabian languages.</li> </ul>
lang	Predefined language code English – en Tamil – ta Telugu – te	lang attribute specify the language used with in the document. Predefined language code will be used for this purpose. Malayalam – ml; Kannada – kn; Hindi – hi; French – fr; German – de;

##### 2. Attributes of <body> tag

The <body> tag defines the document's body. The contents of an HTML page reside within the <body> tag. <body> tag contains several attributes.

###### (i) Background Colour: **bgcolor = color**

By default all the browsers display the text on white background. However, the background color of the browser can be changed by using bgcolor tag.

The tag to change background colour:

**<body bgcolor = color\_name/color\_code>**

**Illustration 10.1 – HTML code to change background colour of a browser**

```

<html>
<head>
    <title> Background Colour change </title>
</head>
<body bgcolor = yellow>
    This is my browser with different colour
</body>
</html>

```

In the above HTML code, colour name has been used to change the background colour of the browser's body section. Generally colors in HTML are represented as six digit hexadecimal values. Colour name can be used for only few colors. But, color code (hexadecimal value) will be more flexible to handle colors.

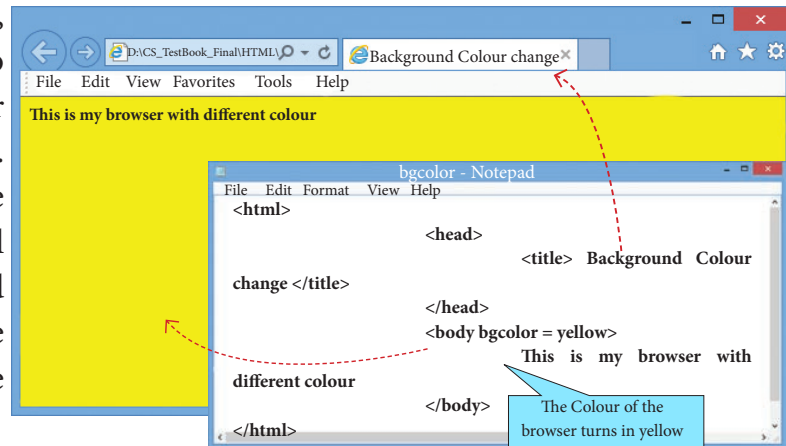

Figure 10.5 Internet Explorer with Yellow background

The six digit hexadecimal value is the combinations of three, two digit number sequence represent a color. First two digits represent Red, next two digits for Green and last two digits for Blue (RGB) in the range of 00 – FF. For example, 000000 is black and FFFFFFFF is white. FF0000 is bright red. You can try out different combinations of these values to get variety of colors.

You can use some basic color names or color code to handle colors in HTML elements. Modern browsers support nearly 140 colors. Color code should be prefixed with #. The following table shows some basic colors with their hexadecimal code.

Table 10.2 – Some basic Color names with code

Color Name	Hexadecimal value	Color Name	Hexadecimal value
Red	#FF0000	Olive	#808000
Blue	#0000FF	White	#FFFFFF
Green	#008000	Black	#000000
Yellow	#FFFF00	Maroon	#800000
Lime	#00FF00	Grey	#808080
Purple	#800080	Aqua	#00FFFF
Silver	#C0C0C0	Brown	#A52A2A

To know the complete color code visit:

[https://www.w3schools.com/tags/ref\\_colornames.asp](https://www.w3schools.com/tags/ref_colornames.asp)

**The above illustration 10.1 can be re-written as follows to get the result**

```
<html>
  <head>
    <title> Background Colour change </title>
  </head>
  <body bgcolor = #FFFF00>
    This is my browser with different colour
  </body>
</html>
```

### (ii) Body text Colour: text = color

The default text colour of body section is “black”, it is often called as automatic color. text attribute within body tag is used to change the text colour.

The tag to change body text colour:

```
<body text = color_name/color_code>
```

**Illustration 10.2 – HTML code to change background and text color of a browser’s body**

```
<html>
  <head>
    <title> Background Colour change </title>
  </head>
  <body bgcolor = #FFFF00>
    This is my browser with different colour
  </body>
</html>
```

To the above code, text will be displayed in Red color on yellow background. You can also use colour code instead of colour name.

### (iii) Background image: background=image

An image or picture can be applied as background to a webpage. When you insert an image as background, the text will be displayed on top of the image. Background images can be a texture or bitmap or even a photo.

When you insert a small image, the browser takes the image and repeats it across and down to fill browser window. Inserting animated images (GIF images) creates more interesting.

The tag to apply an image as background:

```
<body background = “image_name_with_extenstion”>
```



**Illustration 10.3 – HTML code to apply an image as background**

```

<html>
<head>
    <title> Image as background </title>
</head>
<body background = "flower01.gif">
    This is my browser with an image as background
</body>
</html>

```

While including an image as background, the image file name is not required to be in double quotes. The code **<body background = flower01.gif>** can also produce the same result.

If your image file name is long or split as two more words or along with path, should be specify within double quotes.

Remember that, if the image file and HTML source are located in different locations i.e. in different folder or drive, file path should be clearly specified along with image file name. In the above case, image file and HTML source file both are located within the same folder. So, path name is not mentioned.

For example, If the image file is somewhere in a folder (say Images folder in E: drive), you must specify its full path within double quotes as given below.

```
<body background = "E:\Images\ flower01.gif">
```

**(iv) Setting Margins: margin = value**

The margin refers the blank area from left or top edge of the browser window. Generally there is no default margin setting in any browser. If you want to leave some space as margin to left or top; **leftmargin** or **topmargin** attributes will be used respectively.

The tag to specify the left and top margin:

```
<body leftmargin = value topmargin = value>
```

The Value is referred as pixels (72 pixels to an inch)

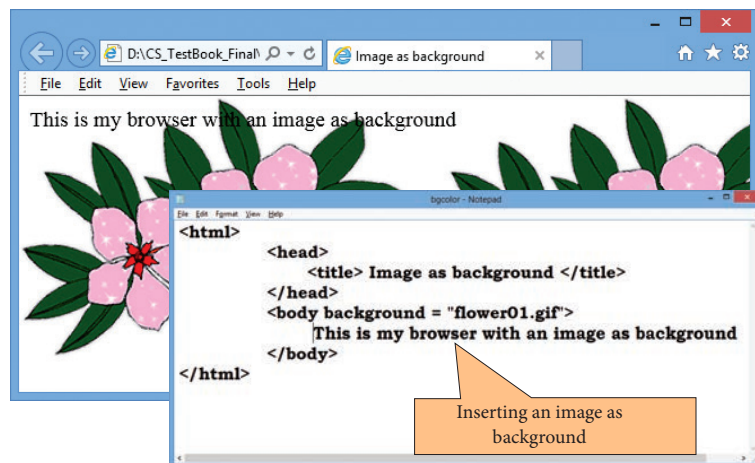

Figure 10.6 Internet Explorer with an image as background

**Illustration 10.4 – HTML code to set left and top margins**

```

<html>
<head>
  <title> Setting Margins </title>
</head>
<body leftmargin = 50 topmargin = 50>
  This is my Web page with top and left margin
</body>
</html>

```

The statement `<body leftmargin = 50 topmargin = 50>` will indent the body text 50 pixels away from the left as well as from top edge of the browser.

**Illustration 10.5 – Create a web page (HTML document) to the following specification.**

- Title: My First Web Page
- Text to be display: Welcome to Computer Applications
- Background color: Lime
- Body text color: Blue
- Margin: from left and top 1 inch

```

<html>
  <head>
    <title> My First Web Page </title>
  </head>
  <body bgcolor = Lime text = blue leftmargin = 72 topmargin = 72>
    Welcome to Computer Applications
  </body>
</html>

```

Remember that, when you use more than one attribute within an HTML element (Tag) space is used as separator.

**10.4 Headings**

Headings are used to include titles to sections of a web page. HTML has six levels of headings viz. **<h1>** to **<h6>**. The number with **h** indicates the level of heading. Header tags are display the body text as bolder and larger in size according to its level.

The syntax of heading tags:

**<h...> Heading text </h...>**

**Illustration 10.6 – HTML code with Headings**

```

<html>
  <head>
    <title> Heading </title>
  </head>
  <body>
    <h1> Welcome to Computer Application</h1>
    <h2> Welcome to Computer Application</h2>
    <h3> Welcome to Computer Application</h3>
    <h4> Welcome to Computer Application</h4>
    <h5> Welcome to Computer Application</h5>
    <h6> Welcome to Computer Application</h6>
  </body>
</html>

```

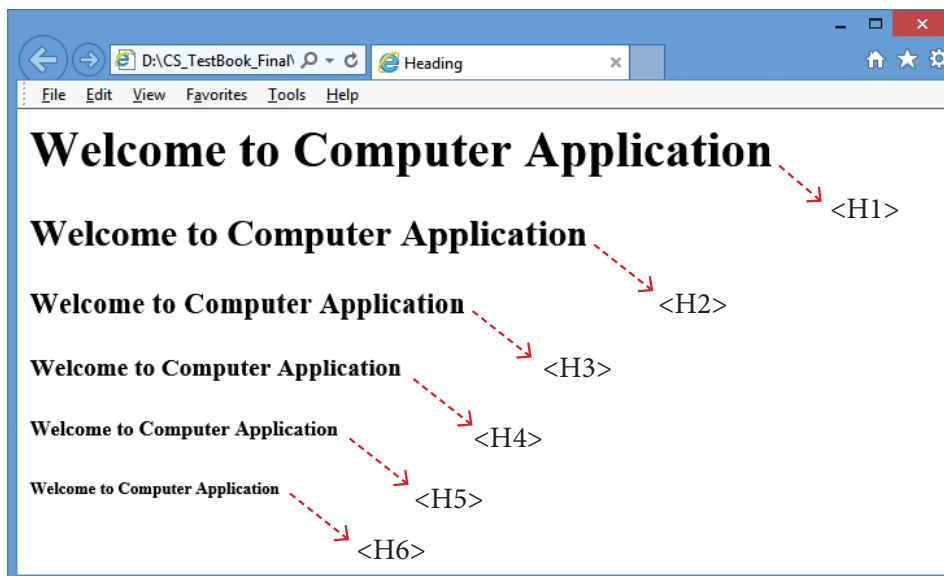

Figure10.7 – Different levels of Headings

**10.4.1 Attribute of Headings tag**

**Align** is an attribute to set right, center and justify alignment to headings. Left is the default alignment, so that it is not supported in latest version of HTML. Justify alignment is not supported by older browsers.

The tag is to specify the alignment to headings:

**<h# align = value>**

Where # is the level number, value may be Right, Center or Justify. Justify alignment only used for paragraphs. The meaning of alignment is similar what you learnt from Word processor.

**Illustration 10.7 – HTML code with Heading and align attributes**

```

<html>
  <head>
    <title> Heading </title>
  </head>
  <body>
    <h1 align=center> Welcome to Computer Application </h1>
    <h2 align=right> Welcome to Computer Application </h2>
  </body>
</html>

```

**10.5 Line Breaks and Paragraphs**

Browser applications are having some special rules for displaying text. They do not recognize returns, tabs or even more than one space between words. If you create an HTML document with multiple lines of text, browser will display it as a single line. (Refer Figure 10.8)

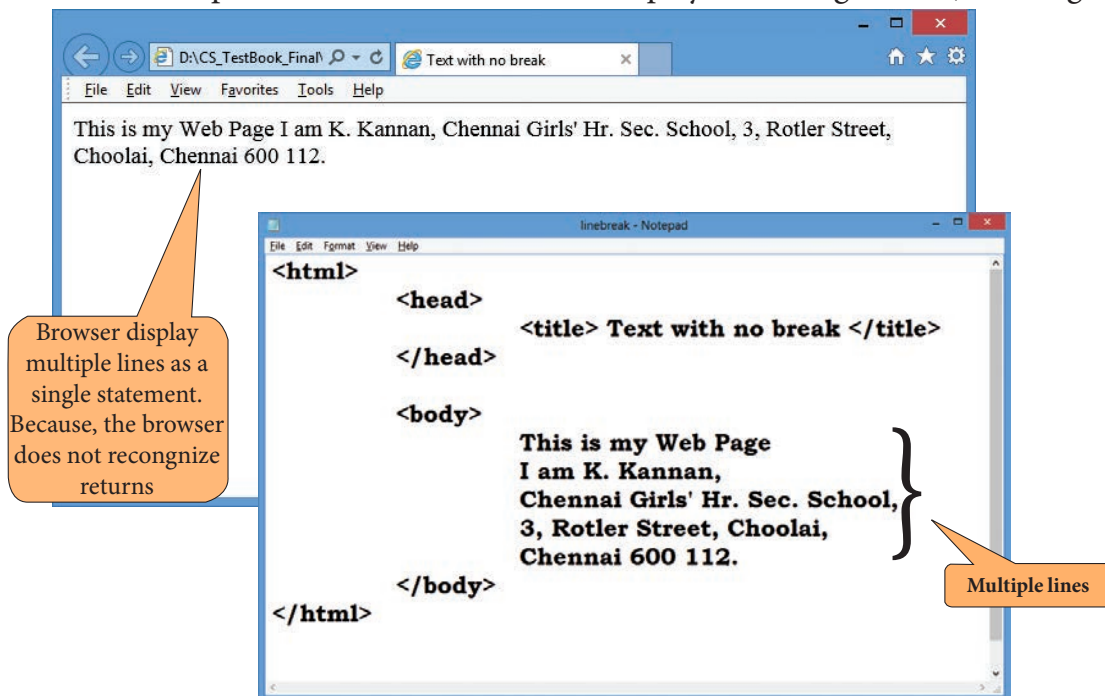
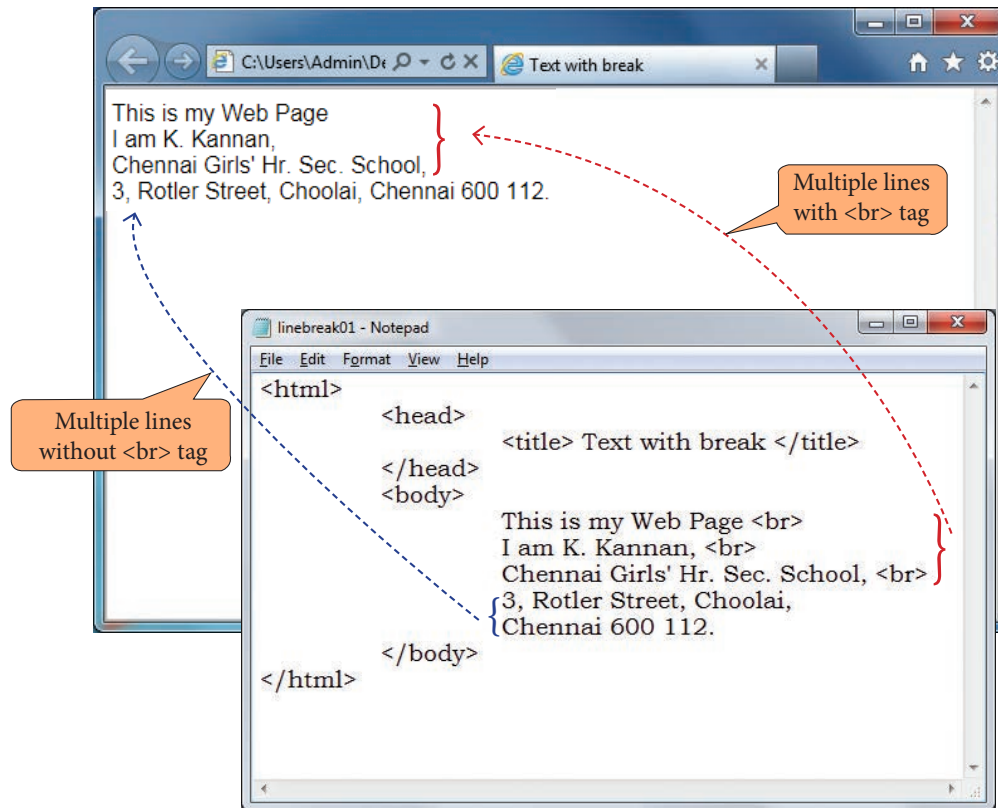

Figure 10.8 Multiline statement displayed as Single line

The `<br>` tag is used for line break. The `<br>` is an empty tag, does not have close tag and attribute. It should be placed at the end of a line. (Refer Figure 10.9)

Figure 10.9 Usage of `<br>` tag

In HTML, paragraphs are created using the `<p>` tag. The content what you type between `<p>` and `</p>` is identified as a paragraph and display as a paragraph by the browser. Because, the browser does not recognize returns (Pressing “Enter” Key). Remember that in word processors, pressing “Enter” key is identifying a paragraph.

#### Illustration 10.8 HTML code to create a paragraph

```
<html>
  <head>
    <title> Paragraph </title>
  </head>
  <body>
    <h1 align=center> Business </h1>
    <p> Business may be defined as any activity in which a man is
    very much interested and these activities bring him profit, money,
    prestige and power. </p> <p> In economic sense, the term business
    means works, efforts and acts of people, which are connected with
    the production of wealth and activities, which are directed with
    the object of making profit.</p> <p> Production and distribution
    of goods to consumers for a profit constitute business. </p>
  </body>
</html>
```

In the above illustration, the contents specified between `<p>` and `</p>` considered as paragraph. Each paragraph displayed separately (Refer Figure 10.10).

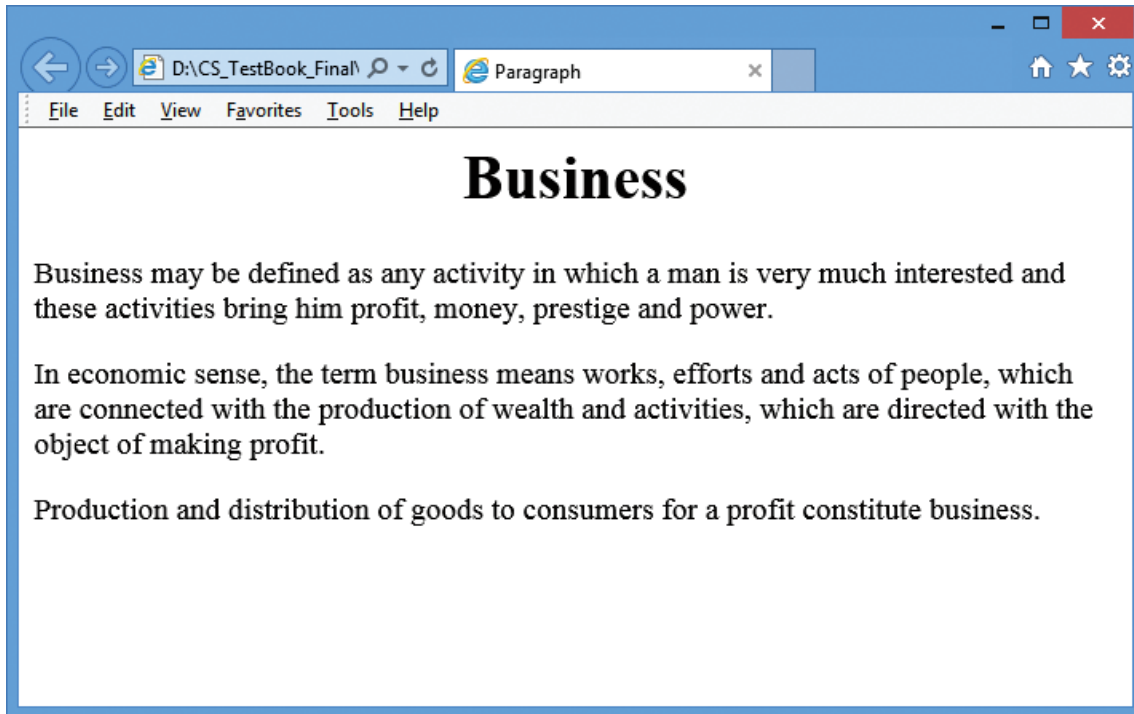

Figure 10.10 Browser with Paragraphs

### Changing Paragraph alignment

You know already that the types of paragraph alignments in Word processor. In HTML documents more are four paragraph alignments viz. Left, Right, Center and Justify. The text that you type between `<p>` and `</p>` is by default aligned to left. To change the alignment of a paragraph **align** attribute can be used with `<p>` tag.

The tag to specify the alignment to paragraphs:

```
<p align = alignment>
```

Where alignment can either be **Right**, **Center** or **Justify**. Remember that, left is the default alignment.

Remember that, the keyboard shortcut to change paragraph alignment in word processor is not working in HTML.

### 10.6 Comments

Comments are used to describe the page or provide some kind of indication of the status of the page. The tag `<!-->` is used to create comments. In HTML, the text what you type within this tag is considered as comments and it is ignored by the browser. Comments never show up onscreen. Comments can be placed anywhere in HTML document.

The general form of comments:

**<! comments >**

### 10.7 Container and Empty Elements

The HTML elements (Tags) can be classified as two types – (1) Container elements (2) Empty elements.

#### Container Elements:

- The tags which are required opening and closing is known as container elements or tags. For example: <html>, <body>, <title>, <p> etc.,

#### Empty Elements:

- The tags which are required only opening tag is known as empty elements or tags. For example: <br>

#### Points to Remember:

- HTML (Hyper Text Markup Language) is a special markup language used to create web pages
- HTML is not a word processing tool or a programming language.
- HTML is made up of tags and its attributes.
- Tags are known as elements of HTML.
- Attribute is special word used inside tag to specify additional information to the tag such as color, alignment etc.
- Every web document has two sections viz. Heading Section and Body Section.
- <html>, <head>, <title> and <body> these four tags are known as structural tags
- List of HTML tags from Section-I

Table 10.3

Opening Tag	Closing Tag	Type	Function	Attributes	Contains	Used inside
<html>	</html>	Container	Delimits a complete HTML document	Dir, Lang	<head>, <body>	
<head>	</head>	Container	Defines the function header	--	<title>	<html>
<title>	</title>	Container	Defines the document title	--	Text	<head>

<code>&lt;body&gt;</code>	<code>&lt;/body&gt;</code>	Container	Defines the document body	Background, Bgcolor, Text, Leftmargin, Topmargin	All tags that controls the appearance of body of the web page	<code>&lt;html&gt;</code>
<code>&lt; h 1 &gt; , &lt; h 2 &gt; .... &lt; h 6 &gt;</code>	<code>&lt;/h 1 &gt; , &lt;/h 2 &gt; , ..... &lt;/ h 6 &gt;</code>	Container	Defines one of six levels of headings	Align	Text	<code>&lt;body&gt;</code>
<code>&lt;p&gt;</code>	<code>&lt;/p&gt;</code>	Container	Defines a paragraph of text	Align	Text	<code>&lt;body&gt;</code>
<code>&lt;br&gt;</code>	--	Empty	Insert a line break	---	---	Text

### Workshop - 1

Type the following code in a text editor, save it as an html file and open in a browser. Observe and study their functions by viewing them in your browser. Then, make the required changes and look what happens.

```

<html>
<body>
<h1> Thai Pongal </h1>
<p> Pongal is a harvest festival dedicated to the Sun. It is a four-day festival which according to the Tamil calendar is usually celebrated from 14 January to 17 January. </p>
<p> Thai Pongal is one of the most important festivals celebrated by Tamil people in Tamil Nadu, Puducherry and the country of Sri Lanka, as well as Tamils worldwide, including those in Malaysia, Mauritius, South Africa, the United States, Singapore, Canada, Myanmar (Burma) and the UK. </p>
<p> Thai Pongal corresponds to Makara Sankranti, the harvest festival celebrated throughout India. </p>
</body>
</html>

```

**Carry over the following changes:**

- Add a suitable title
- Center the heading
- Change the different alignment setting for each paragraph



## Evaluation



### Part – I

#### Choose the correct answer

- HTML is acronym for  
 (a) Hyper Transfer Markup Language      (b) Hyper Text Markup Language  
 (c) Hyper Transfer Makeup Language      (d) Hyper Text Makeup Language
- The coded HTML keywords that indicates how web browser should format and display the content is called.....  
 (a) Tags                      (b) Attributes              (c) Headings              (d) Body
- Which of the following is a special word used inside tag to specify additional information to the tag?  
 (a) Tags                      (b) Attributes              (c) Headings              (d) Body
- HTML tags should be specified within:  
 (a) [ ]                      (b) { }                      (c) ( )                      (d) < >
- An HTML document is bounded within a pair of ..... tags  
 (a) <body> ..... </body>                      (b) <title> ..... </title>  
 (c) <html> ..... </html>                      (d) <head> ..... </head>
- Which of the following symbol is used to define a closing tag?  
 (a) < >                      (b) %                      (c) /                      (d) \
- Which section of the browser window displays the main contents?  
 (a) Head                      (b) Body                      (c) Title                      (d) Heading
- Which of the following tag is a structural tag?  
 (a) <html>                      (b) <h1>                      (c) <br>                      (d) <p>
- In HTML, colours are represented as  
 (a) Binary values      (b) Octal values      (c) Decimal values      (d) Hexadecimal values
- Which of the following symbol is used to prefix with hexadecimal value representing colour in HTML?  
 (a) %                      (b) #                      (c) @                      (d) &
- Which of the following attribute is used to change text colour within body tag?  
 (a) bgcolor                      (c) background                      (c) text                      (d) color
- Within body section, which of the following attribute is used to set top margin?  
 (a) margin                      (b) top                      (c) topmargin                      (d) leftmargin

13. How many levels of heading tags available in HTML?  
 (a) 6 (b) 4 (c) 8 (d) 3
14. The tag used to insert a line break:  
 (a) <h1> (b) <br> (c) <html> (d) <p>
15. The tag used to define a paragraph in HTML:  
 (a) <para> (b) <p> (c) <q> (d) <br>

### Part – II

#### Very Short Answers

- Sandhiya is creating a webpage. She is entering HTML code on her computer. In between, she keeps pressing “Refersh” / “Reload” button on her browser. What is the purpose?
- Explain with the help of an example the difference between container and empty elements of HTML.
- What is the wrong in the following coding?  

```
<html>
<my web page>
<title> Welcome to my web page
</head>
</title>
```
- How do you define comments in HTML?
- How do you include an image as your web page background?

### Part-III

#### Short Answers

- Explain the attributes available with <body> tag.
- What are the attributes available in <html> tags?
- How do you view the source file?
- How do you save a file as HTML file?

### Part-IV

#### Explain in Detail

- Write a HTML program to display your school name and address using various heading level tags.
- Write the basic structure of a HTML program.

## GLOSSARY

<i>HTML</i>	–	<i>Hyper Text Markup Language used to create web pages.</i>
<i>Tag</i>	–	<i>A coded HTML command. It is also called as element.</i>
<i>Attribute</i>	–	<i>Special word, carrying special meaning used inside on HTML tag.</i>
<i>Heading Section</i>	–	<i>Refers title bar of a browser.</i>
<i>Body Section</i>	–	<i>Refers main client area of a browser.</i>
<i>Browser</i>	–	<i>An application to view web pages or web sites.</i>
<i>Web Page</i>	–	<i>An Online page contains hypertext.</i>
<i>Hypertext</i>	–	<i>Text which contains links to other texts.</i>
<i>Text Editor</i>	–	<i>An application used to type and modifies text contents, but it is not a word processor.</i>
<i>Word Processor</i>	–	<i>An application used to create and manipulate text documents.</i>
<i>Notepad</i>	–	<i>A default text editor available with Windows.</i>
<i>Getit</i>	–	<i>A default text editor available with Linux.</i>
<i>Windows</i>	–	<i>Familiar GUI Operating system developed by Microsoft.</i>
<i>Linux</i>	–	<i>Familiar Open Source operating system.</i>
<i>Internet Explorer</i>	–	<i>A browser available with Windows.</i>
<i>Mozilla Firefox</i>	–	<i>A default browser available with Linux. Open Source Third party browser can be installed in windows.</i>
<i>Chrome</i>	–	<i>A familiar web browser developed by Google.</i>

**References:**

1. Mastering HTML, CSS & JavaScript Web Publishing – Laura Lemay, Rafe Colburn, Jennifer Kyrnin – BPB Publications.
2. Informatics Practices, A text book for CBSE class XII – Sumita Arora – Dhanpat Rai & Co.
3. Computer Application (Commerce) – Text book of XII – Department of Education – SCERT, Kerala.
4. <https://www.w3schools.com/html/default.asp>

## HTML - Formatting text, Creating Tables, List and Links

## Learning Objectives:

The students will learn the following:

- How to formatting text contents of an HTML document with variety of tags and attributes.
- How to create and manipulate tables in HTML.
- How to create different types of List.
- What is Link and how to create internal and external links.



In the previous section you learn how to create a web page with basic elements. In this section, you are going to learn about how to format the text such making bold, italic, underline, changing font style, font size, font color and more. Formatting text is very important as well as interesting task in creating web pages. Formatting is purely based on your imagination and creativity.

### 11.1 Text Formatting Tags of HTML

In the previous chapter you learnt how to create a web page with basic elements. In this section, you are going to learn about how to format the text such as making bold, italic, underline, changing font style, font size, font color and more. Formatting text is very important as well as interesting task in creating web pages. Formatting is purely based on your imagination and creativity.

#### 11.1.1 Bold, Italics, Underline

**<b>**, **<i>**, **<u>** are the tags to make the text as bold, italic and underline. These are all container tags. You know well about container tags. All container tags required a closing tag. These tags are otherwise known as “Physical Style” tags.

Table 11.1 Physical Style Tags

Opening Tag	Closing Tag	Description
<b>&lt;b&gt;</b>	<b>&lt;/b&gt;</b>	Text will be bold
<b>&lt;i&gt;</b>	<b>&lt;/i&gt;</b>	Text will be italics
<b>&lt;u&gt;</b>	<b>&lt;/u&gt;</b>	Text will be Underlined
<b>&lt;tt&gt;</b>	<b>&lt;/tt&gt;</b>	Text will be old type writer style i.e. fixed width font

### Illustration 11.1 Text Formatting

```

<html>
<head>
  <title> Text Formatting </title>
</head>
<body>
  <h1 align = center> Kancheepuram </h1>
  <b> Kanchipuram is part of Tondaimandalam </b> <br>
  <i> Kanchipuram is 72 km away from Chennai </i> <br>
  <u> It is the administrative headquarters of Kancheepuram District. </u>
<br>
  <b><i> Kanchipuram is well-connected by road and rail. </i> </b>
  <p> Chennai <b> International Airport </b> is the nearest domestic and
  international airport to the town, which is located at Tirusulam in Kanchipuram
  district. </p>
</body>
</html>

```

Output will be:



#### 11.1.2 <strong> and <em> tags

In addition to bold and italic tags i.e. <b> and <i>, HTML provides <strong>, <em> tags to make the text as bold and italics. These tags are container tags.

##### <strong> Important text

The <strong> tag is a phrase tag. It is used to define important text. This tag displays the text as bold.

##### <em> - Emphasized text

The <em> tag is used to emphasize the text. That means, when you use this tag, the text will be in italics.

Visually these two tags display the contents as very similar as <b> and <i> respectively. But, technically the meaning of <strong> and <em> is “Important” not just bold and italics.

**Illustration 11.2 Usage of <strong> and <em> tags**

```

<html>
  <head>
    <title> Additional Text Formatting Tags </title>
  </head>
  <body>
    <strong> Welcome to Tamilnadu </strong> <br>
    <em> Welcome to Tamilnadu </em>
  </body>
</html>

```

**11.1.3 <big> and <small> tags**

The **<big>** tag is used to define the text bigger in size than the normal size. It is often used to call attention a text.

The **<small>** tag is used to define the text smaller than the current size.

These two tags are container tags.

**Illustration 11.3 Usage of <big> and <small>**

```

<html>
<head>
<title> Small and Big tags </title>
</head>
<body>
  Govenment of Tamilnadu <br>
  <big> Madurai Corporation welcomes you </big> <br>
  <small> Thank you! Visit again </small>
</body>
</html>

```

**11.1.4 Highlighting text**

Highlighting is an important formatting feature is used to call attention to the reader. The **<mark>** tag is used to highlight the text in HTML. This is also a container tag. Whatever the text given between **<mark>** and **</mark>** will be displayed as highlighting with default color (mostly yellow).

**Illustration 11.4 Usage of <mark>**

```

<html>
<head>
<title> Highlighting text </title>
</head>
<body>
    A Computer is an <mark> electronic </mark> device
</body>
</html>

```

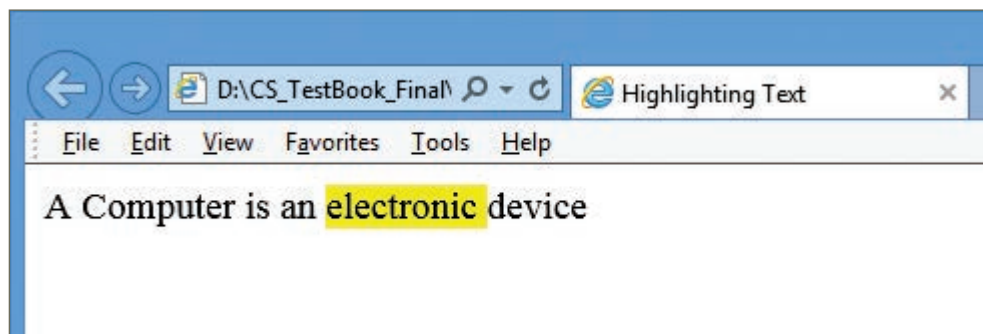
**Output will be:****11.1.5 Subscript and Superscript**

A Subscript is a way to display a character or a number below the normal line of type. For example: The scientific notation for water is H<sub>2</sub>O. It should be written as H<sub>2</sub>O. Here, 2 is appearing below the normal line. This is called subscript.

A Superscript is also a way to show a character or a number above the normal line of type. For example: The familiar algebra equation “a plus b the whole square” should be written as (a+b)<sup>2</sup>. Here, the square value 2 is appearing above the normal line. This is called superscript.

Usually, the subscript and the superscript character or number is smaller than the rest of the text.

In HTML, the <sub> and <sup> tags are used to create subscript and superscripts respectively. As like as other formatting tags, this is also a container tag.

The text or number given between <sub> and </sub> will be displayed as subscript. Same as subscript, the text or number given between <sup> and </sup> will be displayed as superscript.

**Illustration: 11.5 Usage of <sub> and <sup>**

```

<html>
<head>
<title> Subscript and Superscript </title>
</head>
<body>
    The scientific notation of Water is H<sub>2</sub>O <br>
    (a+b)<sup>2</sup> = a<sup>2</sup> + 2ab + b<sup>2</sup>
</body>
</html>

```

The output will be:

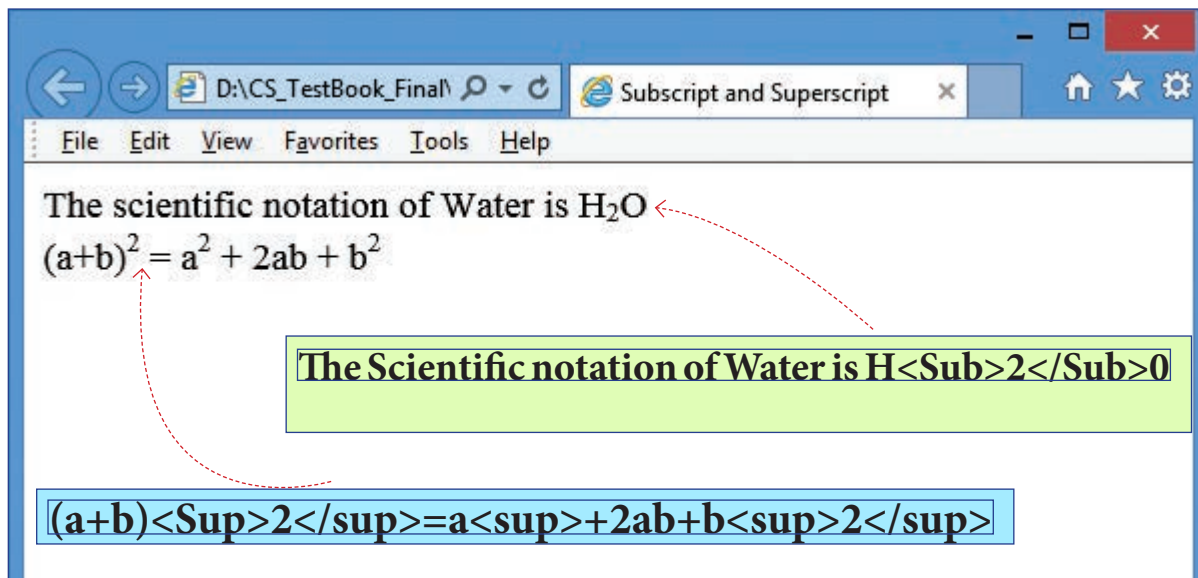
**11.1.6 Inserting and Deleting**

The text what you see on browser cannot delete or insert. But you can show a text as deleted or inserted. **<del>** and **<ins>** tags are used to markup a segment of text as deleted or inserted respectively. These two tags are container tags.

The text what you specify between **<del>** and **</del>** will be displayed as strike through. The text you specify between **<ins>** and **</ins>** will be shown as underlined.



**Illustration: 11.6 Usage of <del> and <ins>**

```

<html>
<head>
<title> Inserting and Deleting text </title>
</head>
<body>
        I am coming from <del> Madras</del> <ins> Chennai </ins>
</body>
</html>

```

**11.1.7 Strike through:**

To display a text as wrong text, the <s> tag can be used to show the text as strike through style. The <s> and <del> tags are display the text in similar way. This is also a container tag. The text you specify between <s> and </s> will be display in strike through style.

**11.1.8 Comparison of tags:**

A few tags do the same things you have learned so far. For example, <b> and <strong>, <i> and <em>, <u> and <ins> and so on. These tags may be shows the same output, but the usage of tags are varying. The following table shows the usage of this kind of tags.

**Table: 11.2**

Tag	Usage	Tag	Usage	Final Output
<b>	To show the text in bold	<strong>	To show important text	Bold
<i>	To show the text as italics	<em>	To Call attention	Italics
<u>	To show the text as underlined	<ins>	To insert a text	Underline
<s>	To show the wrong text	<del>	To replaced or deleted text	Strike through

While writing HTML document, you should use the appropriate tags according to its usage. If you want show a text as underlined use <u> instead of <ins>.

**11.1.9 The Center Tag**

Paragraphs can be centered with Align attribute with <p> tag. But for non-paragraph text contents can be centered with <center> tag. The <center> tag is used to centralize a segment of text. It is a container tag. That means, what you type between <center> and </center> will be displayed in the center of the browser.

**Illustration 11.7 Center the text**

```

<html>
  <head>
    <title> Center the text </title>
  </head>
  <body>
    <h1 align = center> Thiruvallur </h1>
    <center> Thiruvallur was originally known as Thiruvallur which specifies the
    sleeping position of the holy lord <b> "Balaji" <b>, in the
    <b> <u> Veeraragava swamy temple of Thiruvallur. </b> </u> </center>
  </body>
</html>

```

Output will be



## 11.2 Changing font style, size and color

The **<font>** tag is used to change the style, size and color of text. It is also a container tag. It is generally used for changing the appearance of a short segment of text. Before using **<font>**, you should have the knowledge about fonts.

A font is a named set of certain style of character and number. Each font looks different from other fonts. Generally some fonts are used for specific purpose. For example, Times New Roman is a style of font usually used for preparing office documents. Arial is another font style which is used for publishing work. Variety of fonts available in internet at free of cost.

Generally, a browser shows the contents as default system font setting. Every system has different font setting with another system.

**The general form of <font> tag with attributes:**

```
<font face= "font_name" size=value color=color_name / color_code>
```

Text to be displayed

```
</font>
```

- The **face** is an attribute to set different font style. The name of a font has multiple words it should be specified within double quote.
- The size attribute is used to set size of the text. The size can have an absolute value from 1 to 7. These predefined sizes are known as virtual size. Each virtual size is successively 20% larger than the previous one.
- The color attribute is used to set the color to the text. As you learnt earlier color name or color code in hexadecimal may be used.

### Illustration 11.8 HTML code to change font properties

```
<html>
<head>
<title> Changing Font Properties </title>
</head>
<body>
  <font face="Arial Black" size=1 color=red> Font Size 1 </font> <br>
  <font face="Arial Black" size=2 color=blue> Font Size 2 </font> <br>
  <font face="Arial Black" size=3 color=green> Font Size 3 </font> <br>
  <font face="Arial Black" size=4 color=yellow> Font Size 4 </font> <br>
  <font face="Arial Black" size=5 color=pink> Font Size 5 </font> <br>
  <font face="Arial Black" size=6 color=red> Font Size 6 </font> <br>
  <font face="Arial Black" size=7 color=blue> Font Size 7 </font> <br>
</body>
</html>
```

The output will be:

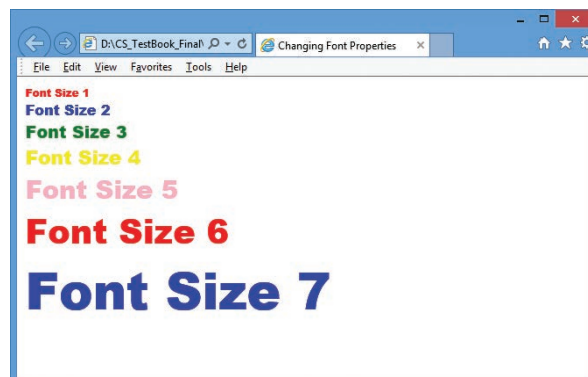

Note: The <font> tag is not supported by HTML5.

#### Multiple fonts with face attribute:

As you learnt already, the face attribute of font tag is used to change font style of a segment of text. In face attribute, you can assign more than one font-name at a time within double quotes with comma. For example,

```
<font face = "Bookman old style1, Broadway1, Forte, Arial">
```

## Welcome to HTML

`</font>`

Browser first tries to find out whether the font-name in the list is supported or not. If the first font is not supported by the browser, then it displays the text in second font, otherwise it will display next one. If no font in the list is supported, then the browser display the in the default font.

In the above code, consider the font names “Bookman old style1” and “Broadway1” are not supported by any browser. (Because, the names has been changed). So, the text “Welcome to HTML” will be displayed in “Forte” style. If your browser not supported “Forte” font, the text will be displayed in “Arial” font, otherwise the browser shows the text as in default font setting. In the case of Internet explorer, the “Times New Roman” is the default font to display the contents.

### 11.3 Section Break

The `<hr>` (Horizontal Rules) tag, which is known as “Thematic Breaks” separate sections of an HTML document visually. It produces a horizontal line spread across the width of the browser. This is an empty tag, which means the tag has no closing tag.

#### Illustration 11.9 An HTML code to demonstrate Horizontal rules tag - `<hr>`

```
<html>
  <head>
    <title> Horizontal Tag </title>
  </head>
  <body>
    <h1 align=center> Tamil Language </h1>
    <font face = "Arial Black" size = 5 color="Red">
    Tamil is a Dravidian language predominantly spoken by the Tamil people of
    </font>
    <hr>
    <font face = "Copperplate Gothic Bold" size = 6 color="Blue">
      India, Sri Lanka, Singapore, Malaysia, Mauritius and South Africa
    </font>
    <hr>
    <font face = "Verdana" size = 6 color="Green">
      Tamil is an official language of India (Tamilnadu and Puducherry),
      Sri Lanka and Singapore.
    </font>
  </body>
</html>
```

The output will be:



#### Attributes of <hr> tag

The <hr> tag having four attributes viz. **size**, **width**, **noshade** and **color**. These attributes are used to set size, width, 3D appearance and color to the horizontal line respectively.

The general syntax of <hr> tag with attributes:

```
<hr size=value width=value noshade, color=color_name/code>
```

#### Size:

Thickness of the horizontal line can be changed with size attribute. The size is given in terms of pixels. A pixel is one of the tiny dots that make up the display on computer. Generally, 72 pixels equal to an inch. Pixel is usually referred as points. For example: The code <hr size = 72> display a horizontal line with 1 inch thickness. The default size is 3 pixels.

#### Width:

The width attribute specifies the horizontal width of the rule line. The default rule is drawn across the full width of the browser. The value of the width attribute may be the exact width of the rule in pixel or a certain percentage. Usually, the value of the width is specified as percentage. 100% is the default width.

#### For example:

<hr width = 50%> display an half of a horizontal rule line on the browser window.

#### Noshade:

The default view of a horizontal rule line is 3D. So, no need to specify the term “noshade” as an attribute with <hr> tag. If you specify the attribute “noshade” turn off 3D view, turns on 2D view. Noshade is a Boolean type attribute.

**Color:**

The horizontal line is displayed in gray color by default. The color attribute is used to change the default color to desired color. As you learnt already, the value of color either is a color name or color code.

**Note: All attributes of <hr> tag is not supported by HTML5**

**Illustration 11.10: An HTML code to demonstrate Horizontal rules with Attributes.**

```
<html>
<head>
  <title> Horizontal Line Attributes </title>
</head>
<body>
  Rule with size 72pixels
  <hr size = 72>
  Rule with size 36pixels, 50% width
  <hr size = 36 width=50%>
  Rule with size 18pixels, 30% width, in 2D
  <hr size = 18 width=30% noshade>
  Rule with size 9pixels, 50% width, 2D, in Green color
  <hr size = 9 width = 50% noshade color=Green>
</body>
</html>
```

The output will be

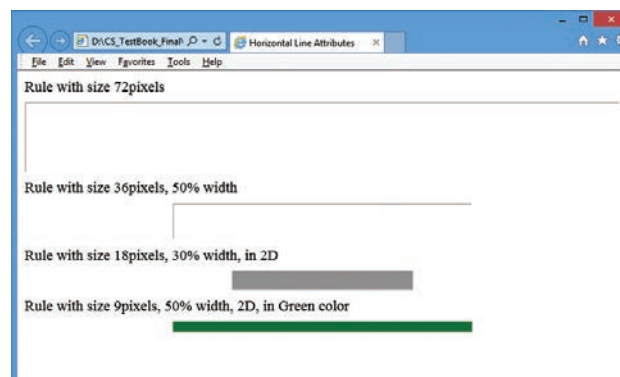

## 11.4 Tables in HTML

Table is grid of rows and columns. Remember, what you learnt about tables in OpenOffice Writer. Creating a table in HTML is not as easy as created in OpenOffice writer. The tables were officially introduced with HTML 3.2. Tables are useful for the general display of tabular data. Representing table in HTML is heavy on tags.

### 11.4.1 Tags to create table elements

There are five core tags are used to create a table in HTML. They are,

- **<table>** tag is used to create a table.
- **<tr>** tag defines table rows
- **<th>** tag defined table columns
- **<td>** tag is used to specify the data in a cell
- **<caption>** tag defines title for the table
- Apart from these five core tags, **<tbody>**, **<thead>** and **<tfoot>** tags are also used to define and control whole sections of table. All the above tags are container tags.

### 11.4.2 Creating Table

With the following illustration, you can learn how to create a table in HTML.

#### Illustration 11.11: An HTML code to Table tags

```
<html>
<head>
  <title> Creating Table </title>
</head>
<body bgcolor="PaleGoldenRod">
  <Table border=1>
  <Caption> Books and Authors </Caption>
  <TR>
    <TH> Book </TH>
    <TH> Author </TH>
    <TH> Publisher </TH>
  </TR>
  <TR>
    <TD> Foxpro 2.5 </TD>
    <TD> R.K. Taxali </TD>
    <TD> BPB Publications </TD>
  </TR>
  <TR>
    <TD> Visual Basic .NET </TD>
    <TD> Jeffrey R. Shapiro </TD>
    <TD> Tata McGraw Hill </TD>
  </TR>
  <TR>
    <TD> Core Java Vol 1 </TD>
    <TD> Horstmann Cornell </TD>
    <TD> Pearson </TD>
  </TR>
</Table>
</body>
</html>
```

In the above HTML code, the **<Table border=1>** tag creates a table structure with border. The code **<Caption> Books and Authors </Caption>** display the text specified between **<Caption>** as title to the table.

The above code contains four set of `<tr>` blocks. First block of `<tr>` creates a table row with three column headings with the help of `<th>` tag. When you use `<th>` tag, the column heading were aligned center and text becomes bold by default.

Rest of the `<tr>` blocks display the contents what you specify within `<td>` tags. All the tags used with table were container tags. So, each and every tag should be closed with their closing tag. The following Figure is more useful to understand the same code given above.

The output will be:

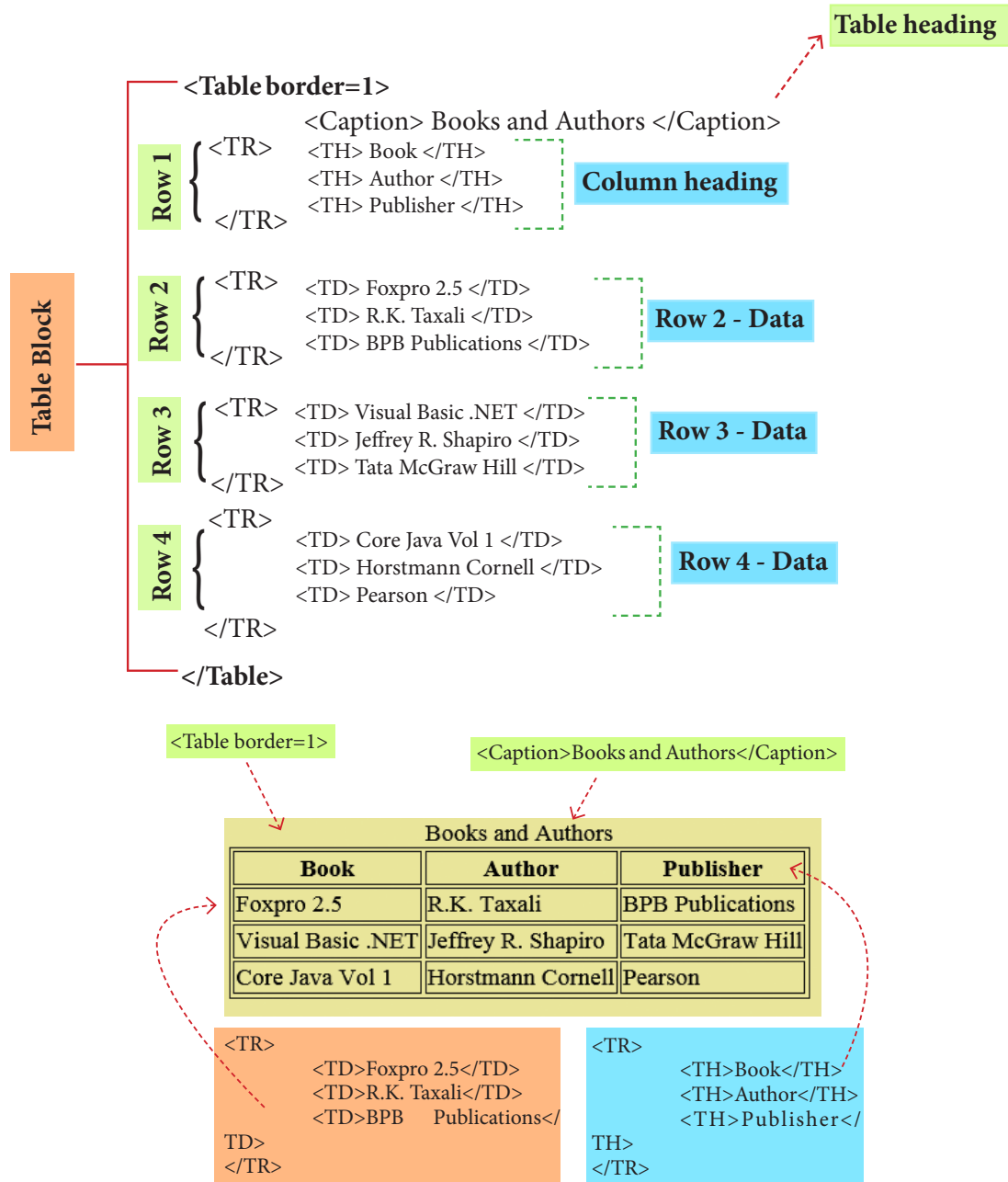

### 11.4.3 Attributes of table

The `<table>` is a container tag. There are several attributes to improve the layout of the table. They are listed below:

#### 1. Cellspacing

It is used to set the space between cells in a table. The value should be in pixels



## 2. Cellpadding

It is used to set the space between the contents of a cell and its border. the value should be in pixels.

## 3. Border:

Border attribute with <table> tag is used to specify the thickness of the border lines around the table. The value of the border attribute should be a non zero value in pixels. If its value is zero, HTML displays the table without border. The default value is Zero in most the browsers.

## 4. Bordercolor:

It is used to apply the colour to the border lines.

## 5. Align:

It is used to set the position of the table within the browser window. Left is the default position. Right or center may be the value of align attribute.

## 6. Bgcolor

It is used to apply background colour to the table.

## 7. Height and Width

These two attributes are used to specify the height and width of a table in terms of pixels or percentage.

### Illustration 11.12: An HTML code to demonstrate the attributes of Table

```
<html>
<head>
<title> Table with Attribute </title>
</head>
<body>
<table cellspacing=5 cellpadding=15 border=4 bordercolor=blue align=center
bgcolor=yellow>
<TR>
<TH> Class </TH>
<TH> Boys </TH>
<TH> Girls </TH>
</TR>
<TR>
<TD> VI </TD>
<TD> 150 </TD>
<TD> 165 </TD>
</TR>
<TR>
<TD> VII </TD>
<TD> 146 </TD>
<TD> 151 </TD>
</TR>
<TR>
<TD> VIII </TD>
<TD> 107 </TD>
<TD> 110 </TD>
</TR>
</table>
</body>
</html>
```

### The output will be:

Class	Boys	Girls
VI	150	165
VII	146	151
VIII	107	110

## Attributes of <TD>, <TH> and <TR> tags:

### 1. Align

Used to specify the horizontal alignment of content within a cell. Left is the default alignment. Possible values are Right and Center.

### 2. VAlign

Used to specify the vertical alignment of the contents within a cell. Bottom is the default alignment. Possible values are Top and Middle

### 3. Width

Used to specify the width of a cell in terms of pixels or percentage.

### 4. Bgcolor and Background

Bgcolor attribute is used to apply a particular colour to the background of a cell.

Background attribute is used to apply an image or picture as background of a cell.

### 5. Rowspan and Colspan

Rowspan attribute is used to merge two or more cells in a row as a single cell.

Colspan attribute is used to merge to two or more cells in a column as a single cell.

#### Illustration 11.13: An HTML code to demonstrate the attributes of <td>, <th> and <tr> tags.

```
<html>
<head>
<title> Attributes of td, tr and th tags </title>
</head>
<body>
<table border align=center>
<Caption> Govt. Hr. Sec. School, Mullai Nagar, Thiruvallur
<tr>
<th colspan=6> Boys and Girls Strength during 2016-17 and 2017-18 </th>
</tr>
<tr align=center>
<th rowspan=2> Class </th>
<th rowspan=2> Group </th>
<th colspan=2 bgcolor=silver> 2016 - 17 </th>
<th colspan=2 bgcolor=gray> 2017 - 18 </th>
</tr>
<tr>
```

```

<th bgcolor=yellow> Boys </th>
<th bgcolor=pink> Girls </th>
<th bgcolor=yellow> Boys </th>
<th bgcolor=pink> Girls </th>
</tr>
<tr align=center>
<th rowspan=2> XI </th>
<th> Science </th>
<td> 75 </td>
<td> 82 </td>
<td> 65</td>
<td> 96 </td>
</tr>
<tr align=center>
<th> Commerce </th>
<td> 125 </td>
<td> 147 </td>
<td> 118 </td>
<td> 163 </td>
</tr>
<tr align=center>
<th rowspan=2> XII </th>
<th> Science </th>
<td> 86</td>
<td> 97 </td>
<td> 71</td>
<td> 106 </td>
</tr>
<tr align=center>
<th> Commerce </th>
<td> 145 </td>
<td> 186 </td>
<td> 130 </td>
<td> 198 </td>
</tr>
</table>
</body>
</html>

```

The output will be:

Govt. Hr. Sec. School, Mullai Nagar, Thiruvallur					
Boys and Girls Strength during 2016-17 and 2017-18					
Class	Group	2016 - 17		2017 - 18	
		Boys	Girls	Boys	Girls
XI	Science	75	82	65	96
	Commerce	125	147	118	163
XII	Science	86	97	71	106
	Commerce	145	186	130	198

## Lists in HTML

HTML supports three types of lists viz. numbered, unnumbered and definition. These lists are called as Ordered List, Unordered List and Definition List respectively.

### 1. Numbered List / Ordered List

Numbered list is created within the tag pair `<OL> ..... </OL>` tag. The tag `<LI>` is used to present the list item in the list. Ordered list displays items in a numerical or alphabetical order. Both `<OL>` and `<LI>` tags are container tags. But the usual the practice, closing tag `</LI>` never be used.

**Illustration 11.14: An HTML code to demonstrate Numbered list**

```

<html>
<head>
<title> Number List </title>
</head>
<body>
<OL>
  <LI> Tamil
  <LI> Telugu
  <LI> English
  <LI> Computer Application
  <LI> Commerce
  <LI> Accountancy
  <LI> Economics
</OL>
</body>
</html>

```

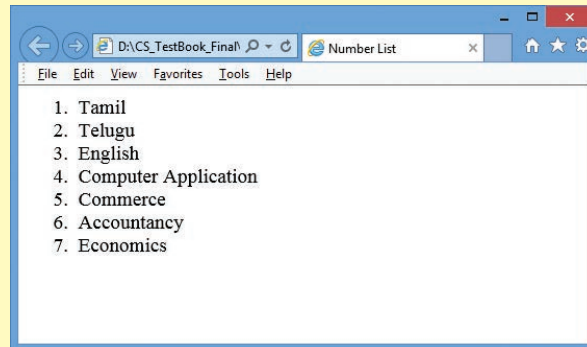
**The output will be:****Attributes of Ordered List:**

There are two attributes can be used to customize ordered list, they are

- (1) **Type** - changing numbering style
- (2) **Start** - changing numbering order.

**Type** – is used to change the number style. The default number style is standard Arabic numerals (1,2,3,.....).

**Table: 11.3**

Type value	Numbering style
1	Standard Arabic Numerals 1,2,3,4,.....
a	Lowercase letters a, b, c, d, .....
A	Uppercase letter A, B, C, D .....
i	Lowercase Roman numerals i, ii, iii, iv, v .....
I	Uppercase Roman numerals I, II, III, IV, V .....

**Start** – is used to specify the number of letter with which start the list. The default starting point is 1. The value of the start attribute should be a decimal number, regardless of the numbering style being used.

**Illustration 11.15: An HTML code to demonstrate attribute of OL tag**

```

<html>
<head>
<title> Attribute of OL tag </title>
</head>
<body>
  <OL type=i start=5>
    <LI> Physics
    <LI> Chemistry
    <LI> Biology
    <LI> Botany
    <LI> Zoology
  </OL>
</body>
</html>

```

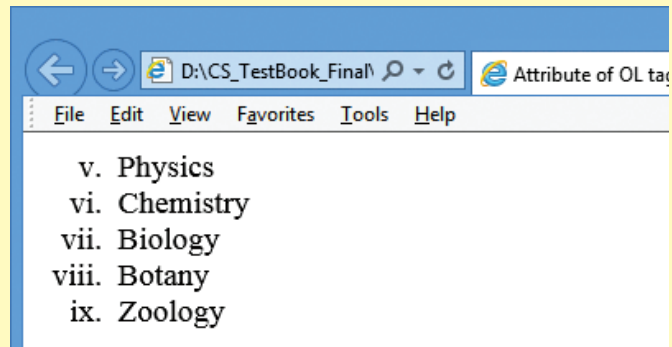
**The output will be:****2. Un-numbered List / Unordered List**

Unordered lists are often referred as bulleted lists. Instead of numbers, each element in the list has prefixed with a special bullet symbol. Unordered list is surrounded within <UL> ..... </UL> tags. As discussed above, each list element is defined by <LI> tag.

**Illustration 11.16: An HTML code to demonstrate Unordered list**

```

<html>
<head>
<title> Unordered List </title>
</head>
<body>
  <UL>
    <LI> Chennai G Hr. Sec. School, Rotler Street, Chennai 600 112.
    <LI> Karnakata Sanga Hr. Sec. School, T. Nagar, Chennai 600 017.
    <LI> S.M.B. Jain Hr. Sec. School, T. Nagar, Chennai 600 017.
    <LI> Chennai G Hr. Sec. School, Nungambakkam, Chennai 600 034.
    <LI> Chennai G Hr. Sec. School, Saidapet West, Chennai 600 015
    <LI> Santhome Hr. Sec. School, Mylapore, Chennai 600 004.
  </UL>
</body>
</html>

```

The output will be:

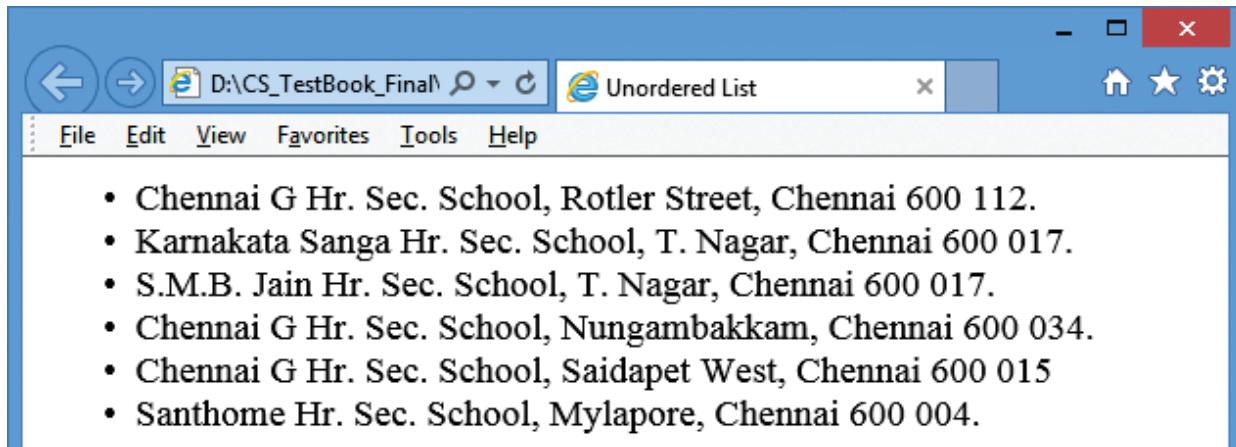

#### Attribute of Unordered List:

Like ordered list, **type** attribute is used to customize bullet style for the list of elements. By default, a solid circle is used as bullets.

Table: 11.4

Type value	Numbering style
Disc	• A solid circle
Square	■ A solid square
Circle	○ An unfilled circle

#### Illustration 11.17: An HTML code to demonstrate Unordered list

```
<html>
<head>
<title> Attribute of UL tag </title>
</head>
<body>
  <UL>
    <LI> Chennai G Hr. Sec. School, Rotler Street, Chennai 600 112.
    <LI> Karnakata Sanga Hr. Sec. School, T. Nagar, Chennai 600 017.
  </UL>
  <UL type=square>
    <LI> S.M.B. Jain Hr. Sec. School, T. Nagar, Chennai 600 017.
    <LI> Chennai G Hr. Sec. School, Nungambakkam, Chennai 600 034.
  </UL>
  <UL type=circle>
    <LI> Chennai G Hr. Sec. School, Saidapet West, Chennai 600 015
    <LI> Santhome Hr. Sec. School, Mylapore, Chennai 600 004.
  </UL>
</body>
</html>
```

The output will be:

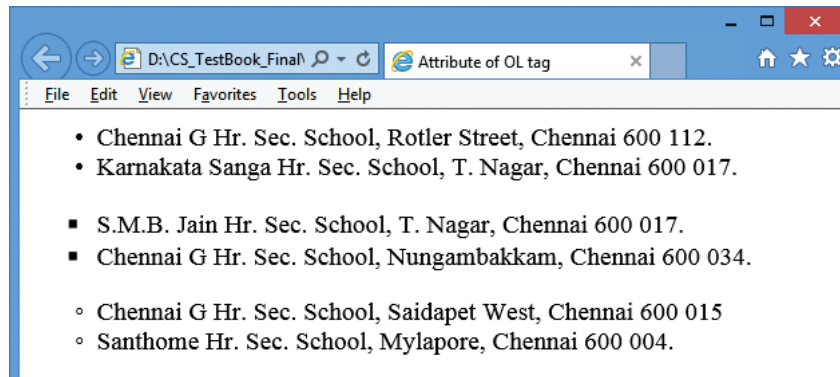

### 3. Definition List

Definition list is different from other two types of list. No bullet or number is provided for the list items. In this list type, the list element has two parts.

- (1) A definition term
- (2) The definition description

Definition list is surrounded within `<DL> ..... </DL>` tags.

Definition term is presented in between `<DT> ..... </DT>` tag and

Definition description should be surrounded within `<DD> ..... </DD>` tag.

#### Illustration 11.18: An HTML code to demonstrate Definition list

```
<html>
<head>
<title> Definition List </title>
</head>
<body>
  <DL>
    <DT> HTML: </DT>
    <DD> Hyper Text Markup Language </DD>
    <DT> Webpage:
  <DD> A web page is a document that is suitable for the World Wide Web and
  web browsers. A web browser displays a web page on a monitor or mobile device.
  </DD>
  </DL>
</body>
</html>
```

The output will be:

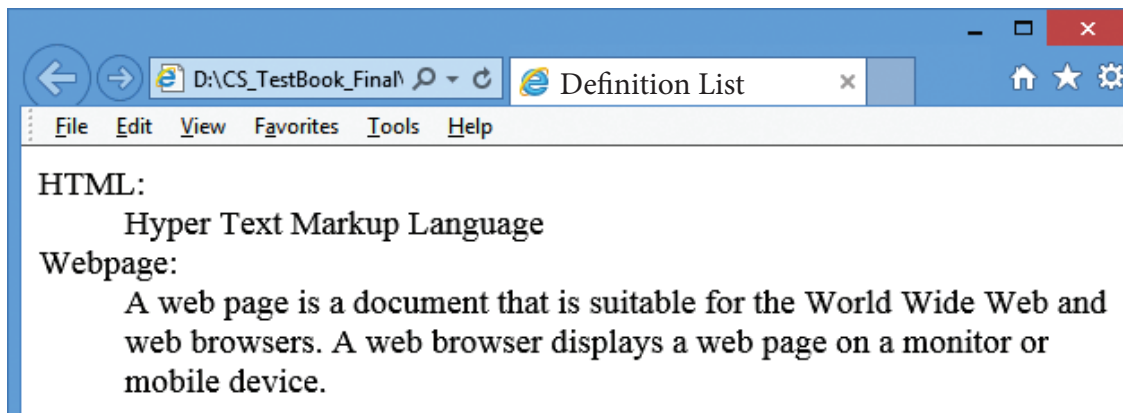

Nested Lists:

A list block can be defined inside another list is called as nested list.

#### Illustration 11.19: An HTML code to demonstrate Nested lists

```
<html>
<head>
<title> Nested List </title>
</head>
<body>
<OL>
  <LI> Districts of Tamilnadu
  <UL type=A>
    <LI> Chennai
    <LI> Madurai
    <LI> Coimbatore
  </UL>
  <LI> District of Kerala
  <UL type=A>
    <LI> Thiruvananthapuram
    <LI> Palakkad
    <LI> Idukki
  </UL>
</OL>
</body>
</html>
```

The output will be:

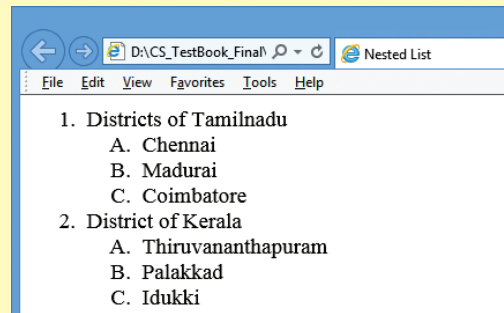

Links:

Link is an important feature of HTML to connect web resources. Link in HTML is used to create hyperlinks to web content. Web content may be an HTML document or an external webpage or any multimedia content such as an image, video, audio, animation etc., or even a part of the current document.



There are two important things needs to create a link in HTML,

- (1) The name of the file or URL to which you want to link
- (2) The text that will serve as the clickable link.

The anchor tag `<A>` is used to create links along with HREF attribute. HREF is abbreviated as “Hypertext Reference”.

**Structure of an anchor tag with href:**

`<A href = “ Web content path / URL “> Text – Clickable link </A>`

**Example:**

`<A href = "http://tncert.org/index.html">SCERT</A>`

The above link code creates the target of the hyperlink to the website `http://thscert.org/index.html`. At the time the user clicks the link, the browser opens the home page of the URL.

**Internal Links:**

Creating a link to a particular section of the same document is known as Internal Link. To create an internal like, the attribute Name is used along with `<A>` tag. The Name attribute of `<A>` tag establish the link to the content within the document.

**Illustration 11.20: An HTML code to demonstrate Internal Linking:**

```

<html>
<head>
<title> South India </title>
</head>
<body>
<h1 align = center> South India </h1>
<p> South India is the area encompassing the Indian states of
<A href = #AP> Andhra Pradesh, </A>
<A href = #KR> Karnataka, </A>
<A href = #KL> Kerala, </A>
<A href = #TN> Tamil Nadu </A> and Telangana as well as the union territories of
Lakshadweep, Andaman and Nicobar Islands and Puducherry, occupying 19% of India's
area (635,780 km2 or 245,480 sq mi). </p>
<A Name = AP><B> Andhra Pradesh </B> </A>
<p> Andhra Pradesh is one of the 29 states of India. Situated in the south-east of the country,
it is the eighth-largest state in India. The largest city in Andhra Pradesh is Visakhapatnam.
</p>
<A Name = KR> <B> Karnataka </B> </A>

```

```
<p> Karnataka is a state in the south western region of India. It was formed on 1 November 1956, with the passage of the States Reorganisation Act. Originally known as the State of Mysore, it was renamed Karnataka in 1973. The capital and largest city is Bangalore (Bengaluru). </p>
```

```
<A Name = KL> <B> Kerala </B> </A>
```

```
<p> Kerala is a state in South India on the Malabar Coast. It was formed on 1 November 1956 following the States Reorganisation Act by combining Malayalam-speaking regions. It is divided into 14 districts with the capital being Thiruvananthapuram.</p>
```

```
<A Name = TN> <B> Tamilnadu </B> </A>
```

```
<p> Tamil Nadu literally 'The Land of Tamils' or 'Tamil Country' is one of the 29 states of India. Its capital and largest city is Chennai (formerly known as Madras). </p>
```

```
</body>
```

```
</html>
```

HTML Link Colors	
	<p>A link will appear in all browsers by default as in the following colour:</p> <ul style="list-style-type: none"> <li>• An unvisited link is underlined and blue</li> <li>• A visited link is underlined and purple</li> <li>• An active link is underlined and red</li> </ul> <p>We can change the default colours, by using CSS will be discussed later.</p>

### External Link:

Establish link with an external web page is known as external linking. It is made possible by providing the URL of the external file in the HREF attribute of <A> tag of the current page.

#### Illustration 11.21: An HTML code to demonstrate Linking with an external website/webpage

```
<html>
<head>
<title> Links </title>
</head>
<body>
  <h1 align=center>
    Welcome to <br>
    <A href = "http://www.tnscert.org">
    State Council of Educational Research and Training, Tamilnadu </A>
  </h1>
</body>
</html>
```

**Illustration 11.22: An HTML code to demonstrate Linking with multiple pages:**  
**<! Master.htm >**

```
<html>
<head>
<title> Linking two pages </title>
</head>
<body>
  <h2> Applications of OpenOffice </h2>
  <ul>
    <LI> <A href=writer.htm> OpenOffice Writer </A>
    <LI> <A href=calc.htm> OpenOffice Calc </A>
    <LI> <A href=impress.htm> OpenOffice Impress </A>
  </ul>
</body>
</html>
```

---

**<! Writer.htm>**

```
<html>
<head>
<title> OpenOffice Writer </title>
</head>
<body>
<h2> OpenOffice Writer </h2>
<p> Writer has everything you would expect from a modern, fully equipped word
processor. </p>
<p> It is simple enough for a quick memo, yet powerful enough to create complete
books with contents, diagrams, indexes, etc. You're free to concentrate on your ideas
while Writer makes them look great. </p>
<A href=master.htm> Back to Home </A>
</body>
</html>
```

---

**<! calc.htm>**

```
<html>
<head>
<title> OpenOffice Calc </title>
</head>
<body>
<h2> OpenOffice Calc </h2>
<p> Calc is the spreadsheet application you've always wanted.
Newcomers find it intuitive and easy to learn; professional data miners and number
crunchers will appreciate the comprehensive range of advanced functions. </p>
<p> DataPilot is an advanced technology that makes it easy to pull in raw data from
corporate databases; cross-tabulate, summarize, and convert it into meaningful
information. </p>
<A href=master.htm> Back to Home </A>
</body>
</html>
```

---

**<! Impress.htm>**

```
<html>
<head>
<title> OpenOffice Impress</title>
</head>
<body>
<h2> OpenOffice Impress </h2>
<p> Impress is a truly outstanding tool for creating effective multimedia presentations.
Your presentations will stand out with 2D and 3D clip art, special effects, animation,
and high-impact drawing tools.</p>
<A href=master.htm> Back to Home </A>
</body>
</html>
```

### Points to Remember:

- `<b>`, `<i>`, `<u>` are the tags to make the text as bold, italic and underline. These tags are otherwise known as “Physical Style” tags.
- Highlighting is an important formatting feature is used to call attention to the reader. The `<mark>` tag is used to highlight the text in HTML.
- The `<sub>` and `<sup>` tags are used to create subscript and superscripts respectively.
- The `<font>` tag is used to change the style, size and color of text.
- A font is a named set of certain style of character and number.
- The `<hr>` (Horizontal Rules) tag, which is known as “Thematic Breaks” separate sections of an HTML document visually.
- Table is grid of rows and columns.
- The tables were officially introduced with HTML 3.2.
- There are five core tags are used to create a table in HTML.
- HTML supports three types of lists viz. numbered, unnumbered and definition. These lists are called as Ordered List, Unordered List and Definition List respectively.
- Link is an important feature of HTML to connect web resources. Link in HTML is used to create hyperlinks to web content.
- Hyperlinks are considered either Internal or External links depends on their target.

### Workshop:

1. Write an HTML code for a webpage of your school with the following specifications:
  - o A heading followed by a paragraph about your school in 10 lines using text formatting tags and attributes.
  - o Include an ordered list with the subjects taught your school.
2. Write an HTML code for a webpage of your district with the following details and features:
  - o A heading followed by a paragraph of 15 sentences about the district using text formatting tags and attributes.
  - o A list of the tourist places in the district. (Use Unordered list)
3. Write an HTML code to show the following table in a webpage:

Students studying Computer Subjects				
SN	School	No. of Students		
		Comp. Science	Comp. Application	Comp. Technology
1	Govt. HSS, M.K.B. Nagar, Chennai 39	25	62	--
2	Chennai G HSS, M.H. Road, Chennai 11	123	141	87
3	Dr. GMTTV HSS, Amman Koil St., Chennai 79	45	76	23
4	Chennai G HSS, Rotler St, Chennai 112	18	63	43
5	Chennai B HSS, G.Koil St., Chennai 84	31	52	15

4. Write HTML codes to create four web pages about Population of Tamilnadu with the following description.
- o In main page write about “Population” (Refer XI Economics text book, Page No: 228-229. Para 11.5) and create list with the following terms:
    - o “Density”, “Urbanisation” and “Sex ratio”.
    - o Write separate pages for “Density”, “Urbanisation” and “Sex ratio” (For contents, refer XI Economics text book, Page No: 229. Para 11.5.1, 11.5.2 and 11.5.3).
    - o In main page, create link with respective pages to the list items.

## Evaluation

### Part – I

#### Choose the correct answer

1. Which of the following tags are called as physical style tags?
 

(A) <html>, <b>,  	(B) <b>,  , <u>
(C) <A>, <b>, <i>	(D) <b>, <i>, <u>
2. Which feature is used to call attention to the reader?
 

(A) Highlight	(B) Bold	(C) Italics	(D) Underline
---------------	----------	-------------	---------------
3. The tags <sub> and <sup> used for:
 

(A) Subject and Super	(B) Subscript and Super
(C) Subject and Superscript	(D) Subscript and Superscript
4. A named set of certain style of character and number is:
 

(A) Style	(B) Character	(C) Font	(D) List
-----------	---------------	----------	----------
5. Pick odd one from the list
 

(A) <tr>	(B) <th>	(C) <dh>	(D) <td>
----------	----------	----------	----------
6. Match the following:
 

(a) tfoot	-	(1) Order list	
(b) start	-	(2) Hyperlink	
(c) href	-	(3) Highlight	
(d) mark	-	(4) Table	
(a)		(b)	(c) (d)

- |     |   |   |     |
|-----|---|---|-----|
| (A) | 4 | 1 | 2 3 |
| (B) | 1 | 4 | 3 2 |
| (C) | 4 | 3 | 2 1 |
| (D) | 1 | 2 | 4 3 |

7. Definition list has how many parts?

- (A) 5                      (B) 4                      (C) 3                      (D) 2



8. A list block can be defined inside another list is:

- (A) Inner List              (B) Nested List              (C) Outer List              (D) Listing List

9. Read the following statement and choose the correct statement(s):

(I) Link in HTML is used to create hyperlinks to web content.

(II) HREF is abbreviated as Hypertext Markup File

- (A) I is correct                      (B) II is correct  
(C) I and II is correct              (D) Both are wrong

10. To create internal link, which of the following attribute should be used?

- (A) link                      (B) name                      (C) local                      (D) Inter

## Part – II

### Very Short Answers

- Write a short note on (i) <strong> (ii) <em>
- What is the use of <mark> tag?
- Write the following equation as HTML notation:  
$$Pd = 2s - Q^2$$
- Write about any two attributes of font tag.
- What is thematic break?
- What is pixel?
- What are the types of list in HTML?
- How will you define numbered list?

### Part-III

#### Short Answers

1. Write an HTML code to display the following text in exactly the same way as given below.  
I am studying Computer Science Application.
2. Briefly explain the attributes of <hr> tag.
3. What are the core tags used to create table in HTML?
4. Write an HTML code to provide hyperlink to <https://www.w3schools.com>
5. Difference between <UL> and <OL> tags.
6. Write HTML code to produce the following table:

A	B
	C

### Part-IV

#### Explain in Detail

1. Write an HTML code the show the following text:

<p>MODERN ATOMIC THEORY</p> <p><b>The findings of modern atomic theory are given as follows:</b></p> <ul style="list-style-type: none"> <li>• An atom is the smallest particle which takes part in chemical reaction.</li> <li>• An atom is considered to be a divisible particle.</li> <li>• The atoms of the same element may not be similar in all respects. eg: Isotopes (<math>^{35}\text{Cl}</math>, <math>^{37}\text{Cl}</math>)</li> <li>• The atoms of different elements may be similar in some respects. eg. Isobars (<math>^{40}\text{Ar}</math>, <math>^{40}\text{Ca}</math>)</li> </ul>
---

2. Explain the attributes used with <table> tag in HTML.
3. Explain the types of list with suitable HTML code.
4. What is Link and explain the types of links.
5. Write HTML code to create the following table:

A	B			
	C	D	E	G
	F			



## GLOSSARY

<i>Text Formatting</i>	–	<i>Showing text with different style and colour.</i>
<i>Font</i>	–	<i>Named set of certain style of character and numbers.</i>
<i>Table</i>	–	<i>A Structure of rows and columns or grid of cells.</i>
<i>Cell</i>	–	<i>An individual box in a table.</i>
<i>Border</i>	–	<i>A line surrounded by cells.</i>
<i>Column</i>	–	<i>Vertical structure of a table.</i>
<i>Row</i>	–	<i>Horizontal structure of a table.</i>
<i>Ordered List</i>	–	<i>Indents lists having numbers or letters in front of every list item.</i>
<i>Unordered List</i>	–	<i>Indents lists having a bullet symbol in front of every list item.</i>
<i>Definition List</i>	–	<i>Lists showing definition terms and definition descriptions.</i>
<i>Link</i>	–	<i>Make connection with a part of content of same document or an external document.</i>
<i>Hyperlink</i>	–	<i>A link from a hypertext document.</i>
<i>Internal Link</i>	–	<i>Connecting with another part of the same document.</i>
<i>Local Link</i>	–	<i>Internal Link</i>
<i>External Link</i>	–	<i>Connection with another hypertext document.</i>

## References:

1. Mastering HTML, CSS & JavaScript Web Publishing – Laura Lemay, Rafe Colburn, Jennifer Kyrnin – BPB Publications.
2. Informatics Practices, A text book for CBSE class XII – Sumita Arora – Dhanpat Rai & Co.
3. Computer Application (Commerce) – Text book of XII – Department of Education – SCERT, Kerala.
4. <https://www.w3schools.com/html/default.asp>

**HTML - Adding multimedia elements and Forms****Learning Objectives:**

The students will learn the following:

- How to insert images with HTML document.
- How to insert music and movies in web pages.
- What is Forms and how to create forms and controls within an HTML document

**12.1 Inserting Images**

Images are essential element to make an HTML presentation as more attractive manner. Moreover images are used to depict many complex concepts in simple way. To make more attractive and communicative web pages, images should be added in the appropriate places.

Images displayed on the web page should be converted to universally supported format. Most of the browsers supports, GIF, JPEG and PNG images formats. HTML-5 introduces SVG images. One format of image can be converted to another format by using Image editing applications such as Photoshop, Picasa, GIMP etc.,

**12.1.1 Familiar Image Formats****GIF (Graphical Interchange Format)**

This format is one of the popular format for animated images. It was developed by CompuServe. Usually this image format is suitable for presenting tiny animated images, logos, icons, line art etc., It is not suitable for photographic work, because it uses maximum of 256 colours. Animated GIF do not support sound or playback control.

**JPEG (Joint Photographic Experts Group)**

JPEG is the most popular image format supported by all web browsers. This format is suitable for photographic images. Unlike GIF, JPEG can include any number of colours.

**PNG (Portable Network Graphics)**

PNG is designed as a replacement for GIF. It is also supported by all browsers.

**SVG (Scalable Vector Graphics)**

SVG is a graphics format that was developed for web. It was standardized by World Wide Web Consortium (W3C) in 2001. All current web browsers supports basic features of SVG.

### 12.1.2 Inserting Images with HTML document

The **<IMG>** tag along with the attribute **src** (Source) is used to add images in HTML document.

#### General format:

```
<img src = image_name_with_extension>
```

(OR)

```
<img src = URL>
```

#### Example:

```
<img src = image1.gif>
```

Src attribute is the main attribute used to specify the file name of the image to be inserted. If the image is not in the current working folder, the image file name should clearly specify with the path of the file or URL, where the file is available.

#### Example:

```
<img src = "D:\images\animals\cat.jpeg">
```

#### Illustration 12.1: An HTML code to insert an inline image

```
<html>
<head>
<title> Inserting Images </title>
</head>
<body>
  <h1 align = center> Bharathiyar </h1>
  <img src = bharathiyar.gif>
</body>
</html>
```

The output will be:

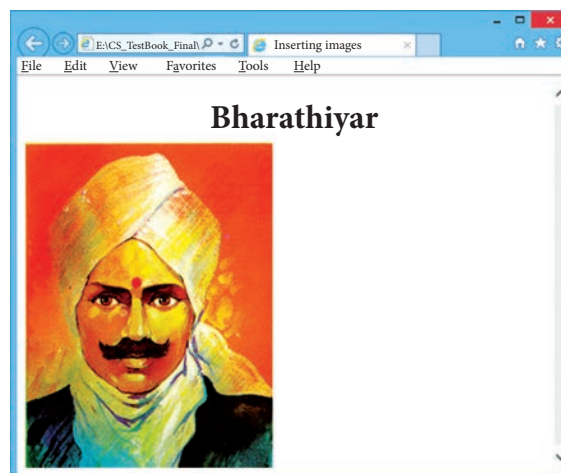

### 12.1.3 Other Attributes of <img> tag:

Other than src, the <img> tag has many attributes the enable to control how the image is presented on the page.

#### Alt (Alternative Text)

The alt attribute within <img> tag is used to describe the image, so that some text is conveyed even when the image cannot be displayed.

#### Example:

```
<img src = bharathiyar.gif alt = "National Poet of India">
```

#### Width and Height:

**Width** and **Height** attributes are used to set the width and height of an image. The values of these attributes should be either pixels or percentage of its actual size. If these attributes are not specified, the browser displays the image in its original size.

#### Vspace (Vertical Space) and Hspace (Horizontal Space):

Vspace and Hspace attributes are used to set Vertical and Horizontal space between the images.

#### Illustration 12.2: An HTML code to demonstrate <img> attributes

```
<html>
<head>
<title> Inserting Images </title>
</head>
<body>
<h1 align = center> Mahakavi Bharathi </h1>
<img src = bharathiyar.gif alt = "National Poet of India" Width = 20% Height = 25%
vspace = 20 Hspace = 20>
<img src = bharathiyar.gif alt = "National Poet of India" Width = 20% Height = 25%
vspace = 20 Hspace = 20>
<img src = bharathiyar.gif alt = "National Poet of India" Width = 20% Height = 25%
vspace = 20 Hspace = 20> <br>
<img src = bharathiyar.gif alt = "National Poet of India" Width = 20% Height = 25%
vspace = 20 Hspace = 20>
<img src = bharathiyar.gif alt = "National Poet of India" Width = 20% Height = 25%
vspace = 20 Hspace = 20> <br>
</body>
</html>
```

The output will be:



### Align:

The align attribute used to aligns the image with respect to the base line of the text. This attribute has the following values.

- Bottom – Aligns the bottom of the image with the baseline of the text. This is the default setting.
- Middle – Aligns the middle of the image with the baseline of the text.
- Top – Aligns the top of the image with the baseline of the text.

### Left and Right values of Align attribute:

Using left and right values with align attribute, displayed the image on the left and right side of the text.

#### Illustration 12.3: An HTML code to demonstrate baseline of text

```
<html>
<head>
  <title> Attributes of <img> tag </title>
</head>
<body>
<h2> Attributes of image tag </h2>
  
  This text is aligned in the bottom of the image by default <br> <br> <br>
  
  This text is aligned in the top of the image <br><br>
  
  This text is aligned on the middle of the image
</body>
</html>
```

The output will be:

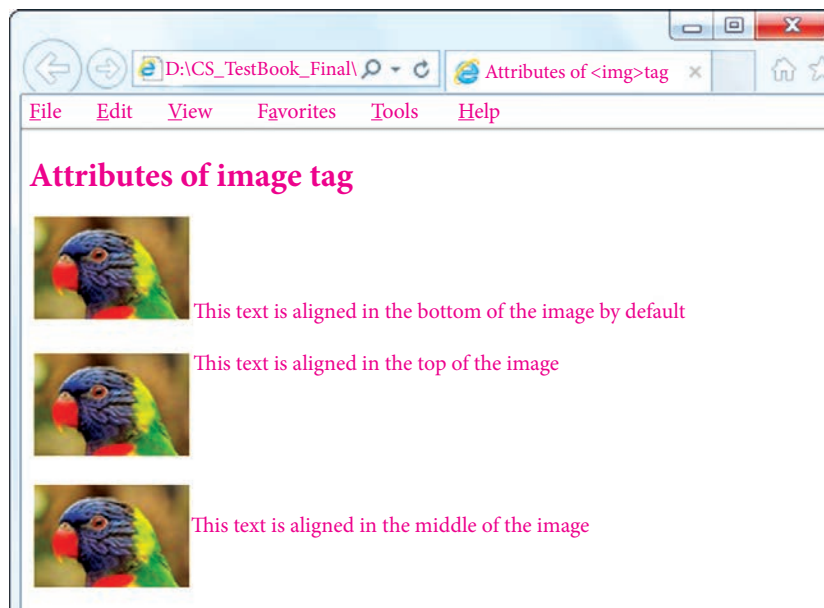

## 12.2 Scrolling text using <Marquee>

In HTML, a piece of text or image can be moved horizontally or vertically by using <marquee> tag. This feature makes a web page as more attractive.

**General format:**

**<marquee> Text or image to be scroll </marquee>**

**Attributes of <marquee>**

**Height and Width**

These attributes are used to set height and width of the marquee. The values should be either in pixels or in percentage of browser window.

**Direction**

This is used to specify the direction of the movement of text or image. The text or image will move towards right to left by default. So, the default direction is left. The Possible values are 'up', 'down', 'left' or 'right'.

**Behaviour:**

This attribute is used to specify the type of scrolling. The values are 'scroll', 'slide' and 'alternate'.

**Scrolldelay:**

This attribute is used to define the time delay between each jump. The time unit should be in seconds.

**Scrollamount:**

This is used to define the speed of the scroll.

**Loop:**

This is for defining how many times the marquee element should repeat on the screen. The default value is 'infinite', which means the marquee element scrolls endlessly.

**Bgcolor:**

This is used to specify the background color to the marquee elements.

**Hspace and Vspace:**

This is for defining the horizontal and vertical space around the marquee. The value can be in pixels or percentage.

**Illustration 12.4: An HTML code to demonstrate marquee**

```
<html>
<head>
<title> Marquee </title>
</head>
<body>
  <marquee> <b> The Government of Tamilnadu </b>, Directorate of School
  Education </marquee>
  <marquee direction=right> Welcome to <b> The State Council of Educational
  Research and Training </b>, Tamilnadu </marquee>
</body>
</html>
```

### 12.3 Adding Video and Sound

Video and Sound are the core part of the modern web pages. In HTML, a video or audio content may be included as Inline or external data. The inline refers to audio or video files are handled as part of the page. These media files play the audio or video when the page is visible in the browser window. The external refers, linking external audio or video files as url.

The **<embed>** tag is used to attach an audio or video file easily within webpage. This tag includes the controls of the multimedia automatically in the browser. The **<noembed>** tag may be used as an alternate to display some other media file, in the case of the browser does not support **<embed>** tag.

**Src** is the primary attribute used with **<embed>** tag. The src attribute used to specify the name of the media file with its source location. Other attributes such as alt, height, width and align are used as it is used with **<img>**.

**General Format:**

**<embed src = audio / video file name with location> </embed>**

### Illustration 12.5: An HTML code to demonstrate adding audio and video files (internal source)

```
<html>
<head>
<title> Adding Multimedii Files </title>
</head>
<body>

<marquee> Welcome to <b> The State Council of Educational Research and Traning
</b>, Tamilnadu </marquee>
<embed src="D:\CS_Videos\CS_Video.mp4" width=50% height=50%> </embed>
</body>
</html>
```

#### 12.3.1 Background music:

Music can be played in the background to a webpage, while the page is viewed. This is known as 'inline' sound or movie. The <bgsound> tag is used to attach an inline sound file in HTML. The src attribute is used to define the location of the media file. Volume attribute used to adjust volume control. The loop attribute defines the duration of play. The 'infinite' value causes the audio play as long as the page is in view.

#### General Format:

**<bgsound src=music file name with location>**

### Illustration 12.6: An HTML code to demonstrate inline sound

```
<html>
<head>
<title> Inline Sound </title>
</head>
<body>

<marquee> Welcome to <b> The State Council of Educational Research and
Training </b>, Tamilnadu </marquee>
<bgsound src="D:\CS_Videos\Tamil Thai Vazhthu.mp3" loop=infinite>
</body>
</html>
```



## 12.4 Working with Forms

Forms are used to receive information from the user. Forms are commonly used to allow users to register on a Web site, to log in to a Web site, to order a product, and to send feedback. In search engines, forms are used to accept the keywords for search.

The `<form>` tag is used to create a form. An HTML form starts with `<form>` and ends with `</form>` tag. Forms contain many types of form elements, such as text boxes, radio buttons, check boxes, buttons and drop-down lists.

The form has a special element, which is **submit** button, which will submit the entries of a form to a server application to process the entries. Each element in the form is assigned a name using the **name** attribute. Users enter values into the text boxes, or make selections from the radio buttons, check boxes, and drop down lists. The values they enter or select are passed with the name of the corresponding form element to the Web server.

### 12.4.1 Attributes frequently used with `<form>` tag

The important attributes used with the `<form>` tag are method and action attributes.

#### Method

The method attribute of the **form** tag is used to identify how the form element names and values will be sent to the server. The **get** method will append the names of the form elements and their values to the URL. The **post** method will send the names and values of the form elements as packets.

#### Action

The **action** attribute identifies the server side program or script that will process the form. The action will be the name of a Common Gateway Interface (CGI) program written in programming languages like Perl, JavaScript, PHP or Active Server Pages (ASP). (This will be discussed with JavaScript in this book).

Figure 12.1 HTML Form Controls

#### General Format of `<form>` tag

```
<Form method=get/post action="back_end_server_script">
```

## Form elements

`</Form>`

### 12.4.2 Form Controls:

In HTML, there are different types of form controls are used to collect data. They are Text box, Password, Checkbox, Radio buttons, Text area, Select box, Submit and Reset Button.

#### 12.4.2.1 `<Input>` Tag

Most of the form controls are created by using `<input>` tag. The `<input>` is an empty tag used to create different form elements or controls such as text box, radio buttons so on.

#### Attributes of `<input>` tag:

##### Type:

This attribute is used define the type of control to be created by `<input>` tag. The values of type attribute is listed below:

Table: 12.1

Value of type attribute	Description
Text	Create a Text Box. The element used to get all kind of text input such as name, address etc.,
Password	Similar as Text box. But, while entering data, the characters are appearing as coded symbols such as asterisk.
Checkbox	Check box is an element appearing like a small square box. When the user click on the square a tiny tick mark will appear inside the square. This element is used to select multiple options.
Radio Button	Radio button is used to select any one of the multiple options from the list. This element looks like a small circle, when the user select an item, a tiny dot will appear within the circle. If the user selects another option, previously selected option will be deselected. This means, user can select any one of the given option form a group.
Reset	It is a special command button used to clear all the entries made in the form.
Submit	It is also a special command button used to submit all the entries made in the form to the backend server.
Button	This is a standard graphical button on the form used to call functions on click.

**Name:**

This attribute of <input> tag is used to assign a name to the input controls. When the form is submitted, the data values are passed to the server along with the names of the controls.

**Value:**

This attribute is used to define default value to some controls.

**Size:**

This is used to set the width of the input text in terms of characters. It is applicable only for textbox and password boxes.

**Maxlength:**

This attribute of <input> tag is used to set the length of the input character (number of characters to be inputted) to the textbox and password boxes.

### Illustration 12.7: An HTML code to demonstrate Form and Form controls (Login form)

```
<html>
<head>
  <title> Login Form </title>
</head>
<body>
<h3 align=center> TamilNadu State Council of Educational Research and Training,
Chennai </h3>
<Form Action = "mailto:abcd.xyz@com" method=post>
  <p> User Name:
  <Input type = text name="user_name" size = 20 maxlength = 15> </p>
  <p> Password:
  <Input type = password name="pass" size = 20 maxlength = 15> </p>
  <Input type = reset value = "Clear">
  <Input type = submit value = "Login">
</Form>
</body>
</html>
```

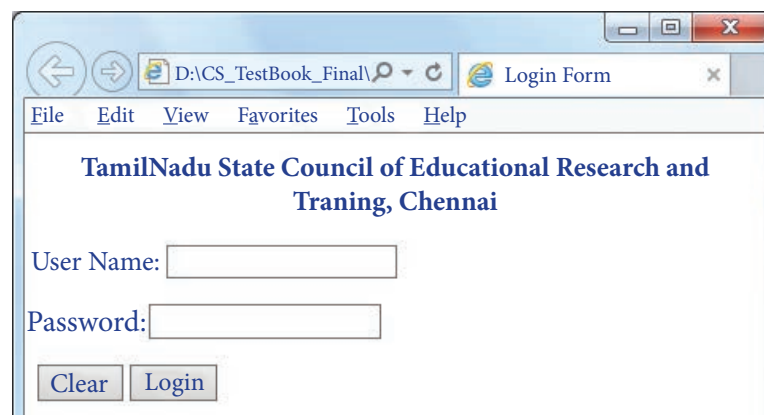
**The output will be:**

**Note:** Data received from the user can send to receiver through mail using “mailto” action.

### Illustration 12.8: An HTML code to demonstrate Form and Form controls (Text box, checkbox and radio buttons)

```

<html>
<head>
  <title> HTML - Form and Controls </title>
</head>
<body>
<h3 align=center> Forms and Controls </h3>
<Form action="mailto:abcd.xyz@com" method=post>
  <p> Student Name:
  <input type=text name=name size=30 maxlength=25></p>
  <p> Gender:
  <input type=radio name=gender value=boy> Boy
  <input type=radio name=gender value=girl> Girl
  </p>
  <p> Subjects:
  <input type=checkbox name=sub value=Tam> Tamil
  <input type=checkbox name=sub value=Tel> Telugu
  <input type=checkbox name=sub value=Eng> English
  <input type=checkbox name=sub value=Phy> Physics
  <input type=checkbox name=sub value=Eco> Economics
  </p>
  <input type=reset name=reset value="Clear">
  <input type=submit name=submit value="Submit">
</Form>
</body>
</html>

```

The output will be:

The screenshot shows a web browser window with the following content:

**Forms and Controls**

Student Name :

Gender:  Boy  Girl

Subjects:  Tamil  Telugu  English  Physics  Economics

### 12.4.2.2 <Select> Tag

The <select> tag is used to create dropdown list box in HTML. It provides a list of various options as a dropdown list. This element is more helpful when a number of options are to be displayed in a limited space. The <option> tag is used to specify list items.

#### Attributes of <Select> tag:

**Name** – Provide the name to the control, which is sent to the server.

**Size** – Determine the style of dropdown list box.

Size = 1 dropdown list box

Size = 2 List box

**Multiple** – Allows user to select multiple values.

#### Attributes of <Option> tag:

**Selected** – Indicate default selection

**Value** – Value to be submitted to server

#### Illustration 12.9: An HTML code to demonstrate Form and Form controls (Dropdown List box)

```
<html>
<head>
  <title> HTML - Form and Controls </title>
</head>
<body>
<h3 align=center> Forms and Controls </h3>
<Form action="mailto:abcd.xyz@com" method=post>
<p> Student Name:
<Input type=text name=name size=30 maxlength=25></p>
<p> City / Town:
<Select name = area size= 1>
  <option value = CHN> Chennai </option>
  <option value = MDR selected> Madurai </option>
  <option value = CBO> Coimbatore </option>
  <option value = KKM> Kanyakumari </option>
</Select> </p>
<input type=reset name=reset value="Clear">
<input type=submit name=submit value="Submit">
</Form>
</body>
</html>
```

The output will be

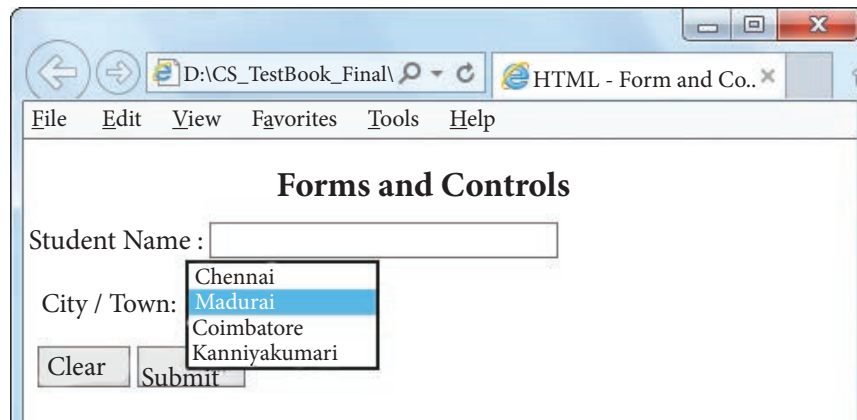

#### 12.4.2.3 <Textarea> tag

The <Textarea> tag is used to receive multi line text data as input. It is a container tag. The main attributes of <Textarea> are

**Name** – Used to define name to the control

**Rows** – Specifies the number of rows in the text area control

**Cols** – Specifies the number of columns in the text area. (number of characters in a line)

#### Illustration 12.10: An HTML code to demonstrate Form and Form controls (Text Area – Multiline input)

```
<html>
<head>
  <title> HTML - Form and Controls </title>
</head>
<body>
<h3 align=center> Forms and Controls </h3>
<Form action="mailto:abcd.xyz@com" method=post>
  <p> Student Name:
  <Input type=text name=name size=30 maxlength=25></p>
  <p> Email:
  <input type=text name=mail size=30 maxlength=25> </p>
  <p> Comments: <br>
  <Textarea rows=5 cols=50 name=comments> </Textarea>
  </p>
  <input type=reset name=reset value="Clear">
  <input type=submit name=submit value="Submit">
</Form>
</body>
</html>
```

The output will be:

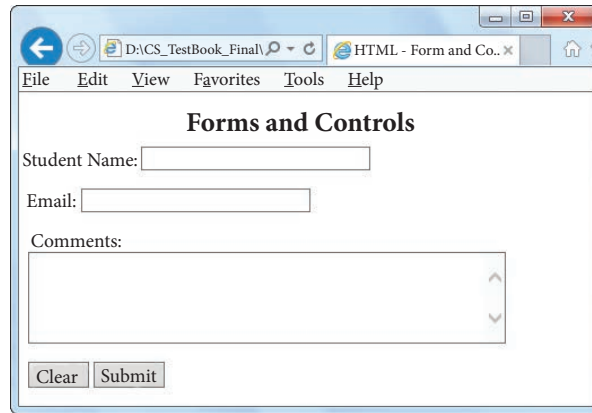

**Illustration 12.11: An HTML code to demonstrate All Form controls discussed in this chapter**

```

<html>
<head>
  <title> HTML - Form and Controls </title>
</head>
<body>
<h3 align=center> Students Data Entry Form </h3>
<Form action="mailto:abcd.xyz@com" method=post>
<p> Student Name:
<input type=text name=name size=30 maxlength=25></p>
<p> Email:
<input type=text name=mail size=30 maxlength=25> </p>
<p> Gender:
<input type=radio name=gender value=boy> Boy
<input type=radio name=gender value=girl> Girl
</p>
<p> Subjects:
<input type=checkbox name=sub value=Tam> Tamil
<input type=checkbox name=sub value=Tel> Telugu
<input type=checkbox name=sub value=Eng> English
<input type=checkbox name=sub value=Phy> Physics
<input type=checkbox name=sub value=Eco> Economics
</p>
<p> City / Town:
<Select name = area>
  <option value = CHN> Chennai </option>
  <option value = MDR selected> Madurai </option>
  <option value = CBO> Coimbatore </option>
  <option value = KKM> Kanyakumari </option>

```

```

</Select> </p>
<p> Comments: <br>
<Textarea rows=5 cols=50 name=comments> </Textarea>
</p>
<input type=reset name=reset value="Clear">
<input type=submit name=submit value="Submit">
</Form>
</body>
</html>

```

The output will be:

The screenshot shows a web browser window with the title 'HTML - Form and Co.'. The browser address bar shows 'D:\CS\_TestBook\_Final\'. The page content is a form titled 'Students Data Entry Form'. The form contains the following elements:

- Student Name:
- Email:
- Gender:  Boy  Girl
- Subjects:  Tamil  Telugu  English  Physics  Economics
- City / Town:
- Comments:
- Buttons: Clear, Submit

### Points to Remember:

- Images are essential element to make an HTML presentation as more attractive manner.
- Most of the browsers supports, GIF, JPEG and PNG images formats.
- The <IMG> tag along with the attribute src (Source) is used to add images in HTML document.
- In HTML, a piece of text or image can be move horizontally or vertically by using <marquee> tag.
- In HTML, a video or audio content may be included as Inline or external data.
- The <embed> tag is used to attach an audio or video file easily within webpage.
- Music can be played in the background to a webpage, while the page is viewed.
- The <bgsound> tag is used to attach an inline sound file in HTML.
- Forms are used to receive information from the user.
- An HTML form starts with <form> and ends with </form> tag.
- Most of the form controls are created by using <input> tag.
- The <select> tag is used to create dropdown list box in HTML.
- The <Textarea> tag used to receive multi line text data as input.



**Workshop:**

1. Write an HTML code insert Image, Music and Video elements
2. Write an HTML code to display an application for as shown below:

**Evaluation****Part - I****Choose the correct answer**

1. Which image format was standardize by W3C?  
(A) JPEG                      (B) SVG                      (C) GIF                      ( D )  
PNG
2. The tag used to insert an image in HTML:  
(A) Image                      (B) Picture                      (C) Img                      (D) Pic
3. In HTML, a piece of text or image can be moved horizontally or vertically by using:  
(A) <marquee>                      (B) <img>                      (C) <embed>                      (D) <text>
4. Inline sound can be inserted using which of the following tag?  
(A) <inline>                      (B) <backgroundsound>                      (C) <bgsound>                      (D) <sound>
5. Which value causes the audio play as long as the page is in view?  
(A) Stop                      (B) Never Stop                      (C) Continue                      (D) Infinite
6. The important attributes used with the <form> tag are  
(A) method and action                      (B) name and size  
(C) post and get                      (D) type and name



7. The tag is used to create dropdown list box in HTML is:  
 (A) <dropdown> (B) <select> (C) <listbox> (D) <input>
8. Match the following:
- |                |   |                     |
|----------------|---|---------------------|
| (a) <textarea> | - | (1) inline          |
| (b) <input>    | - | (2) Video           |
| (c) <bgsound>  | - | (3) Multiline input |
| (d) <embed>    | - | (4) Password        |
- |     |     |     |     |     |
|-----|-----|-----|-----|-----|
|     | (a) | (b) | (c) | (d) |
| (A) | 3   | 1   | 4   | 2   |
| (B) | 3   | 4   | 1   | 2   |
| (C) | 2   | 3   | 4   | 1   |
| (D) | 2   | 1   | 3   | 4   |

### Part - II

#### Very Short Answers

- List out the popular image formats.
- Write down the general format of marquee
- What is inline sound or movie?
- What is the purpose of <input> tag?
- Which tag is used to specify the list of items in dropdown list box?
- What are the major attributes are available in <textarea> tag?

### Part-III

#### Short Answers

- Write a short note on familiar images format.
- How will you scroll the text in HTML?
- Explain the main attributes used with <form> tag.
- Explain the values of <input> tag's type attribute.
- Explain the attributes of <select> and <option> tags.

#### Case study:

Create a website of your own interest which includes all the features learned from these chapters for your school

**GLOSSARY**

<i>GIF</i>	<i>Graphical Interchange Format.</i>
<i>JPEG</i>	<i>Joint Photographic Experts Group.</i>
<i>PNG</i>	<i>Portable Network Graphics.</i>
<i>SVG</i>	<i>Scalable Vector Graphics.</i>
<i>Photoshop</i>	<i>Familiar Photo editing tool developed by adobe.</i>
<i>Picasa</i>	<i>Free image organizer and editing tool developed by Lifescape.</i>
<i>GIMP</i>	<i>Open source image editing tool.</i>
<i>HTML 5</i>	<i>Latest version of HTML authorized by w3c</i>
<i>W3C</i>	<i>The World Wide Web Consortium; an International standards organization for the www.</i>

**References:**

1. Mastering HTML, CSS & JavaScript Web Publishing – Laura Lemay, Rafe Colburn, Jennifer Kyrnin – BPB Publications.
2. Informatics Practices, A text book for CBSE class XII – Sumita Arora – Dhanpat Rai & Co.
3. Computer Application (Commerce) – Text book of XII – Department of Education – SCERT, Kerala.
4. <https://www.w3schools.com/html/default.asp>

## CSS - Cascading Style Sheets

## Learning Objectives:

After learning this chapter, the student will be able to

- Understand the uses of CSS
- How to create separate CSS Files to format various elements of HTML
- How to use a CSS file in HTML 9.1 Necessity of Internet



## Introduction:

In the previous chapters we discussed about the variety of HTML tags and the attributes to design a webpage. As you already know about the formatting tags and its attributes, in some situations, you may need to use a tag uniformly in the entire document. To do so, we can use `<style>` tag. A style tag is used to change the default characteristics of a particular tag in the entire web document wherever that tag is used.

For example, if you want to display `<h3>` tag in a particular font style and size with blue colour in the entire page, you can use `<style>` tag to define its properties in head section as follows.

```
<html>
<head>
<title> Usage of the <style> tag </title>
<style>
  h3
  { color:blue;
    font-family: "Copperplate Gothic Bold";
    font-size:14pt; }
</style>
</head>
<body>
<h3> Welcome to learn HTML </h3>
<h3> Welcome to learn CSS </h3>
<h3> Welcome to learn JavaScript </h3>
</body>
</html>
```

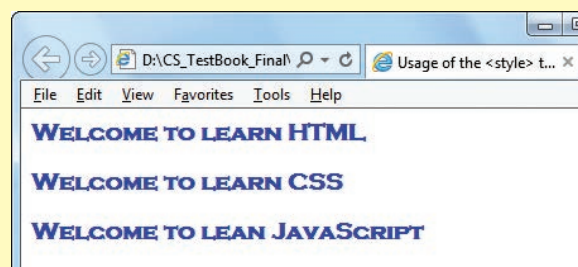

In the above code segment, the style of `<h3>` header tag is clearly defined. So, hereafter, the content between `<h3>` and `</h3>` will be displayed as per its definition. The output of the above code is shown as below:

The `<style>` tag controls the presentation styles of a particular HTML document.

If you want to use a particular tag with the same style applied in one HTML document to another is not possible. Thus, the <style> tags are called as “**Page-Level Styles**” or “**Internal Style sheets**”.

The “Internal Style sheet” is defined and implemented only within an HTML document. If you want use the same style to multiple pages, you should define styles as a separate style file. These separate style files are known as “**Sitewide Style sheets**” or “**External Style Sheets**”. Professional web developers do not use internal styles.

There is another style method called “**Inline style**”, which is used to define style for a particular tag anywhere in an HTML document. You can define styles for any tag within an HTML document. But it is applicable only on that line where it is defined. If you use the same tag, again in the same document, it does not reflect the new style.

In this chapter, we are going to discuss about External Style Sheets or Sitewide Style Sheets that is about CSS.

### Sitewide Style Sheets:

**Cascading Style Sheets (CSS)** are also called as Sitewide Style sheets or external style. CSS is a style sheet language used for describing the formatting of a document written in HTML. Using CSS, you can control the font colour, font style, spacing between pages, columns size, border colour, background image or colour and various other effects in a web page. In external styles, you can store all style information in a separate file and include it in your web pages using an HTML tag. The separate file should be saved with the extension .css

### Advantages of CSS

**Maintainability** -CSS are also defined and stored as separate files. So, the style and appearance of a web page can be dynamically changed and maintain with less effort.

**Reusability** - The styles defined in CSS can be reused in multiple HTML pages.

**Easy to understand** - The tags in web pages are well organized with style specifications and therefore it is easy to understand.



**Hakon Wium Lie**

CSS was invented by **Hakon Wium Lie** on October ,10 1994 and maintained through a group of people within the W3C called the CSS Working Group.



### CSS – Style definition rules

The body of the style sheet consists of a series of rules.



CSS style declaration consists of two major parts; Selector and Declaration. The Selector refers an HTML tag in which you want to apply styles. The Declaration is a block of code contains style definition. It should be surrounded by curly braces. You can include any number of properties for each selector, and they must be separated by semicolons. The property name and its value should be separated by a colon. Each declaration should be terminated by a semicolon ( ; ).

**Example:**

Selector	Declaration of properties and values
P	<pre>{   Font-size : 16pt;   color : red;   font-weight : bold; }</pre>

In the above example, the style properties are defined to <p> tag. Hereafter, whenever you use the <p>, the contents will be displayed with modified properties. If you want to use the above style definition as an internal style then it should be specified within <style> ..... ,</style> block in head section. If you want store the above definition for using all your web pages, you should save the above code as a separate file with extension .css

**CSS – Frequently using Text formatting Properties and Values**

Table: 13.1

Formatting	Properties	Values	Example
Text Colour	Color	Predefined_Color_Name	<pre>P {   color:pink; } H1 {   color : MediumSeaGreen; }</pre>
Text Alignment	Text-align	Center / Left / Right / Justify	<pre>P {   Text-align : center; }</pre>
Font type	Font-family	Font_name	<pre>P {   Font-family : "Times New Roman"; }</pre>
Font Style	Font-style	Normal / Italic	<pre>P {   Font-family : "Times New Roman";   Font-style : Italic; }</pre>

Formatting	Properties	Values	Example
Font Style (Bold)	Font-weight	Normal / Bold	P { Font-family : "Times New Roman"; Font-style : Italic; Font-weight : bold; }
Font size	Font-size	Size in pixels	P { Font-family : "Times New Roman"; Font-style : Italic; Font-size : 14px; }
Background Colour	Background Colour	Predefined_Color_Name	Body { background-color : violet; }
Border Colour	Border	Border thickness <space> border style <space>Predefined_ borderColor_Name	H2 { border : 2px solid red; }
HTML supports nearly 140 color names.			
Background Image	Background-image	URL ("image name with extension")	Body { background-image : url ("Flower.gif"); }
	Background-repeat	norepeat	Body { background-image : url ("Flower.gif"); background-repeat : norepeat; }
	Background-position	Direction	Body { background-image : url ("Flower.gif"); background-repeat : norepeat; background-position : right top; }
Paragraph Margin	Margin-top Margin-bottom Margin-left Margin-right	Margin size in pixels	P { Margin-top : 50px; Margin-left : 50px; }

**Creating CSS style sheets:**

- Open an empty **notepad**.
- Type the style properties and their values as given in the table given above.
- Save the file with extension **.css**

**Illustration 13.1 My First CSS file**

```
P {
font-style : Italic;
color :MediumSeaGreen;
}
H1
{
border:2px solid red;
}
```

The above code should be saved with extension **.css**

**Linking CSS with HTML**

The **<link>** tag is used to add CSS file with HTML in head section. While using **<link>** tag, the following attributes are also included along with standard values.

rel = "stylesheet"

type = "text/css"

The href attribute is used to link the .css file.

**General format of <Link> tag**

**<Link rel = "stylesheet" type = "text/css" href = CSS\_File\_Name\_with\_Extension>**

**Illustration 13.2 Formatting HTML element through CSS****Mystyle.css**

```
H1
{
font-family : "Comic Sans MS";
Font-weight : Bold;
border:2px solid blue; }
P {
font-style : Italic;
color :MediumSeaGreen; }
```

**--- CSS\_Test.htm ---**

```
<html>
<head>
<title> Demonstration of using CSS </title>
<link rel="stylesheet" type="text/css" href="mystyle.css">
</head>
<body>
<H1> Welcome to CSS </H1>
<P>
CSS was invented by HakonWium Lie on October 10, 1994 and maintained through
a group of people within the W3C called the CSS Working Group. The CSS Working
Group creates documents called specifications. When a specification has been
discussed and officially ratified by W3C members, it becomes a recommendation.
</P>
</body>
</html>
```



Output will be:

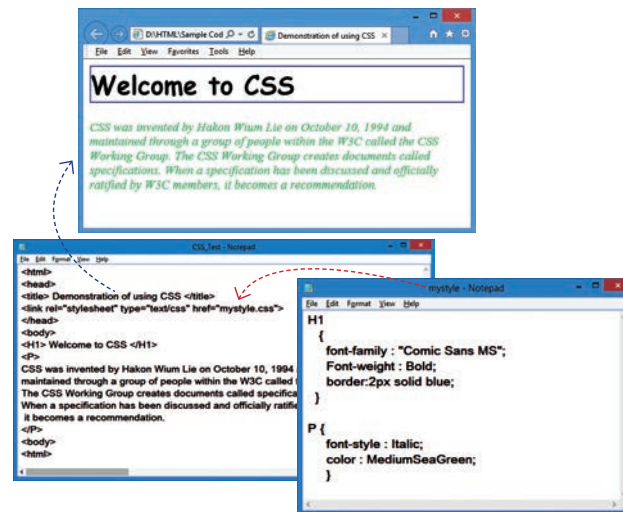

Illustration 13.3 Changing background color of browser using CSS

--- Back\_Color.css ---

```
body
{
background-color : pink;
}
```

--- Background\_CSS.htm ---

```
<html>
  <head>
    <title> Changing Background using CSS </title>
    <link rel = "stylesheet" type="text/css" href="Body_Color.css">
  </head>
  <body>
    <H1> Welcome to CSS </H1>
  </body>
</html>
```

### CSS Comments

Many times, you may need to put additional comments in your style sheet blocks. So, it is very easy to comment any part in style sheet. You can simply put your comments inside /\*.....**this is a comment in style sheet**.....\*/.

### CSS - Workshop

- Develop a web page about your school with CSS.
- Develop a web page describing about your district. Use CSS to format HTML structural tags.

### Points to Remember:

- The <style> tag controls the presentation styles of a particular HTML document.
- The <style> tags are called as “Page-Level Styles” or “Internal Style sheets”.
- Professional web developers do not use internal styles.
- The separate style files are known as “Sitewide Style sheets” or “External Style Sheets” or CSS
- CSS is easy to learn and understand but it provides powerful control over the presentation of an HTML document.
- Most commonly, CSS is combined with the markup languages HTML or XHTML.
- There is another style method called “Inline style” which is used to define style for a particular tag anywhere in an HTML document.
- Electronic governance or e-governance is the application of information and communication technology (ICT) for delivering government services.

### Evaluation



#### Part – I

#### Choose the correct answer

- Expansion of CSS  
 (A) Cascading Style Schools (B) Cascading Style Scheme  
 (C) Cascading Style Sheets (D) Cascading Style Shares
- Which of the following is the page level style?  
 (A) <Page> (B) <Style> (C) <Link> (D) <H>
- CSS is also called as:  
 (A) Sitewide Style Sheets (B) Internal Style Sheets  
 (C) Inline Style Sheets (D) Internal Inline Sheets
- The extension of CSS file is  
 (A) .ssc (B) .css (C) .csc (D) .htm
- What is selector?  
 (A) Property (B) Value (C) HTML tag (D) name
- The Declaration block of CSS is surrounded by  
 (A) ( ) (B) [ ] (C) { } (D) <>
- The declaration should be terminated by  
 (A) : (B) ; (C) . (D) ,
- What is the property to set text as bold?  
 (A) Font-Style (B) Font-Weight (C) Font-Property (D) Font-Bold
- Which of the following indicates that the text included is a comment ?  
 (A) /\* \*/ (B) !\* \*! (C) <\* \*> (D) \\* \*\\

10. Which of the following ways below is correct to write a CSS?
- (A) `p{color:red; text-align:center};`      (B) `p {color:red; text-align:center}`  
 (C) `p {color:red; text-align:center;}`      (D) `p (color:red;text-align:center;)`

### Part – II

#### Very Short Answers

1. What is the use of `<style>` tag?
2. What is CSS?
3. Write the general format of linking CSS with HTML.
4. What is Inline Style?
5. Write down general format of CSS declaration.

### Part-III

#### Short Answers

1. What are the advantages of using CSS?
2. Write a short note on rule of CSS.
3. Write a CSS file to define text color and alignment to `<p>` tag.
4. Write a CSS file to define font type, style and size to `<h1>` tag.

### Part-IV

#### Explain in Detail

1. Write an HTML document to display the following paragraph as per the given description Using CSS:
  - Font Name : Cooper Black
  - Style : Bold Italics
  - Color : Blue

“The State Institute of Education (SIE) was established in 1965 to provide for systematic study of problems relating to School Education under the administration of Directorate of School Education.”
2. List and explain the Font and text element properties and values used CSS.

#### GLOSSARY

Style Sheet	-	A separate file contains the style of appearance.
Selector	-	An HTML element
Property	-	Attribute of an HTML tag
Link	-	Connecting with another file

#### References:

- Mastering HTML, CSS & JavaScript Web Publishing – Laura Lemay, Rafe Colburn, Jennifer Kyrnin – BPB Publications.
- Informatics Practices, A text book for CBSE class XII – Sumita Arora – Dhanpat Rai & Co.

## Introduction to JavaScript

## Learning Objectives:

- To understand about JavaScript Language and advantages of JavaScript
- To understand the importance of Client side code, Steps to follow to JavaScript Programs.
- To understand JavaScript Variables, Declaring Variables and Rules for naming Variables – Scope of Variables and assigning values to variables.
- To develop the skills of Web page development using HTML and CSS
- To acquire the skills of web scripting using JavaScript
- To develop the skills of Internet and Online applications



### 14.1 Introduction to JavaScript:

On December 4, 1995, Netscape and Sun Inc. jointly introduced JavaScript 1.0. JavaScript had truly bridged the gap between the simple world of HTML and the more complex Common Gateway Interface (CGI) programs on the Server. It provides a common scripting language for Web developers to design, test and deploy Internet Applications.

The JavaScript client-side technology provides many advantages over traditional CGI Server-side scripts. For example, JavaScript code can be used to check if the user has entered a valid e-mail address in a form field. The JavaScript code is executed when the user click **Submit** button in the form, and only if all the entries are valid, they would be submitted to the Web Server.

### 14.2 Advantages of JavaScript Programming Language

- In HTML chapter we have learnt how to develop static web pages. But in real life web pages must be interactive. So to develop such interactive pages (Dynamic Web page ) JavaScript programming language is used.
- User entered data in the Dynamic Web page can be validated before sending it to the server. This saves server traffic, which means less load on your server.
- JavaScript includes such items as Textboxes, Buttons, drag-and-drop components and sliders to give a Rich Interface to site visitors. For example Creating a New email account in any service provider.

### 14.3 Using JavaScript in HTML page with <script> tag :

JavaScript can be implemented using <script>... </script> tags. The <script> tag containing JavaScript can be placed anywhere within in the web page, but it is normally recommended that should be kept it within the <head> tags. The <script> tag alerts the

browser program to start interpreting all the text between these tags as a script commands.

The syntax of JavaScript segment in Hyper Text Markup Language (HTML) or Dynamic Hyper Text Markup Language (DHTML) is as follows:

```
<script language="javascript" type="text/javascript">
```

**JavaScript code**

```
</script>
```

The <SCRIPT> tag takes two important attributes –

**Language** – This attribute specifies that the scripting language. Typically, its value will be **javascript**. Although recent versions of HTML (EXtensible HyperText Markup Language - XHTML, its successor) have phased out the use of this attribute is optional.

**Type** – This attribute is used to indicate the scripting language and its value should be set to "text/javascript".

#### 14.3.1 Steps to follow to code JavaScript Language

- Enter HTML and JavaScript code using any text editor.
- Save the latest version of this code.
- Use any browser to see the result. For example : Internet Explorer, Google Chrome, etc.,
- If this is a new document, open the file via browser's **Open Menu**. If the document is already loaded in the Memory, to reload the file into the browser use "**Refresh**" or press **F5** button.

#### 14.3.2 First JavaScript Program

##### Illustration 14.1 Simple JavaScript Program

```
<Html>
  <Head>
    <Title>My First JavaScript Program</Title>
    <script language="javascript" type="text/javascript">
      document.write("Hello World!")
    </script>
  </Head>
  <Body>
</Body>
</Html>
```

##### Output:

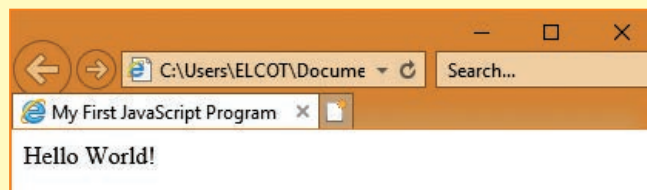

### 14.4 Lexical Structure of a JavaScript Program

The lexical structure of a programming language is the set of elementary rules that specifies how to write programs in that language. It is the lowest-level syntax of a language. The

Lexical structure specifies variable names, the delimiter characters for comments, and how one program statement is separated from the next.

- Though JavaScript is a case-sensitive language. It is good programming practice to type the command in lowercase.
- JavaScript ignores spaces that appear between tokens (identifiers, operators, punctuation, constants and keywords) in programs.
- JavaScript supports two styles of comments. Any text follow a “//” and the end of a line is treated as a single line comment and is ignored by JavaScript. Any text between the characters “/\* \*/” is also treated as a multiline comment.
- JavaScript uses the semicolon (;) to separate statements. Many JavaScript programmers use semicolons to explicitly mark the ends of statements.
- A literal is a data value for variable that appears directly in a program.
- An identifier is simply a name. In JavaScript, identifiers are used to name variables, functions and to provide labels for certain loops in JavaScript code.
- In JavaScript certain **keywords** are used as reserved words, These words cannot used as identifiers in the programs

### 14.5 JavaScript Variables:

Variable is a memory location where value can be stored. Variable is a symbolic name for a value. Variables are declared with the **var** keyword in JavaScript. Every variable has a name, called identifier.

#### 14.5.1 Basic Data types and Declaring variables:

Every variable has a data type that indicates what kind of data the variable holds. The basic data types in JavaScript are Strings, Numbers, and Booleans.

- A **string** is a list of characters, and a string literal is indicated by enclosing the characters in single or double quotes. Strings may contain a single character or multiple characters, including whitespace and special characters such as **\n** (the newline).
- **Numbers** can be integer or floating-point numerical value and numeric literals are specified in the natural way.
- **Boolean** can be any one of two values: **true** or **false**. Boolean literals are indicated by using true or false directly in the source code.

Variables are declared in JavaScript using var keyword that allocates storage space for new data and indicates to the interpreter that a new identifier is in use. Declaring a variable in JavaScript as follows:

```
var no;
var no1,no2;
```

The **var no;** statement tells the interpreter that a new variable **no** is about to be used and **var no1,no2;** tells the interpreter that **no1** and **no2** are variables.

#### 14.5.2 Rules for naming variable

1. The first character must be a letter or an underscore (\_). Number cannot be as the first

character.

2. The rest of the variable name can include any letter, any number, or the underscore. You can't use any other characters, including spaces, symbols, and punctuation marks.
3. JavaScript variable names are case sensitive. That is, a variable named **RegisterNumber** is treated as an entirely different variable than one named **registernumber**.
4. There is no limit to the length of the variable name.
5. JavaScript's reserved words cannot be used as a variable name. All programming languages have a supply of words that are used internally by the language and that cannot be used for variable names.

### 14.5.3 Scope of variables

The scope of a variable is the life time of a variable of source code in which it is defined.

- A global variable has global scope; it can be defined everywhere in the JavaScript code.
- Variables declared within a function are defined only within the body of the function. They are local variables and have local scope.

### 14.5.4 Assigning values to variables

Variables can be assigned initial values when they are declared as follows:

```
var numericData1 = 522;
var stringData = "JavaScript has strings\n It sure does";
var numericData = 3.14;
var booleanData = true;
```

#### Illustration 14.2 Declaring Variables

```
<Html>
<Head>
  <Title>Demo Program - Declaring Variables in JavaScript </Title>
</Head>
<Body>
<script language="javascript" type="text/javascript">
var numericData1 = 522;
var stringData = " JavaScript has strings\n It sure does";
var numericData = 3.14;
var booleanData = true;
document.write("Numeric Data : "+numericData1);
document.write("<br> String Data : "+stringData);
document.write("<br> Floating Data : "+numericData);
</script>
</Body>
</Html>
```

## Output

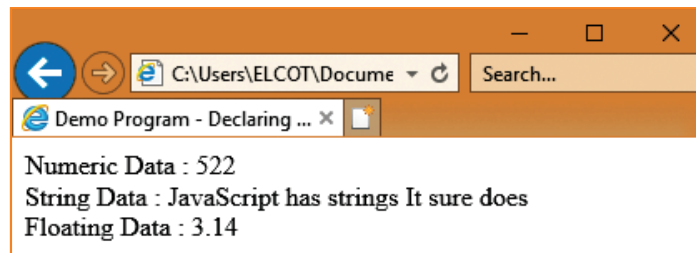

In addition, multiple variables can be declared with one **var** statement, if the variables are separated by commas:

```
var no1=50, no2=5065;
```

JavaScript allows the implicit declaration of variables by using them on the left-hand side of an assignment. In JavaScript there is no need to indicate data type during variable declarations. JavaScript variables are untyped and it is dynamically datatyped which means initially you can assign a value of any data type to a variable and later you can assign a value of different data type to the same variable. For example:

```
var value=100;
```

```
var value="JavaScript";
```

### 14.5.5 JavaScript Literals

A literal is a fixed value given to a variable in source code. Literals are often used to initialize variables. Values may be Integer, Floating point, Character, String and Boolean. For Example,

```
var int_const=250; //Integer constant//
```

```
var float_const=250.85; //Floating point constant//
```

```
var char_const='A'; //Character constant//
```

```
var string_const="Raman"; //String constant//
```

```
var boolean_const=true; //Boolean constant//
```

### write statement:

#### General Syntax:

```
document write ("string " + var);
```

### 14.5.6 Type casting in JavaScript.

Type conversion is the act of converting one data type into a different data type which is also called as casting. In JavaScript there are two type of **casting**,

- Implicit casting and
- Explicit casting

Implicit casting occurs automatically in JavaScript when you change the data stored in a variable:



## 14.6 JavaScript Operators and Expressions

An operator combines the values of its operands in some way and evaluates to a new value. Operators are used for JavaScript's arithmetic expressions, comparison expressions, logical expressions, assignment expressions.

An expression is a phrase of JavaScript that a JavaScript interpreter can evaluate to produce a value. The data types are used directly as literals or within variables in combination with simple operators, such as addition, subtraction, and so on, to create an expressions. An expression is a code fragment that can be evaluated to some data type the language supports. An expression is simply one or more variables and/or constants joined by operators. An expression is evaluated and produces a result. The result of all expressions may be either an integer or floating-point value or Boolean value. There are three types of expressions as follows,

- Arithmetic expressions
- Relational expressions
- Logical expressions

### 14.6.1 Arithmetic Operators

JavaScript supports all the basic arithmetic operators like addition (+), subtraction (-), multiplication (\*), division (/), and modulus (%), also known as the remainder operator).

Table: 14.1 – Arithmetic Operators

Arithmetic Operator	Meaning	Example	Result
+	Addition	var sum = 20 + 120	Variable sum = 140
-	Subtraction	var diff = 20 - 120	Variable diff = 100
*	Multiplication	var prod = 10 * 100	Variable prod = 1000
/	Division	var res = 100/522	Variable res = 5.22
%	Modulus operator	var rem = 100 % 522	Variable rem = 22 (remainder)

#### Illustration 14.3 Using Arithmetic Operators

```
<Html>
<Head>
  <Title>Demo Program – To test Arithmetic Operators in JavaScript
</Title>
</Head>
<Body>
  <script language="javascript" type="text/javascript">
```

```

var value1 = 522, value2=10;
document.write("<br>Data1 : "+value1);
document.write("<br>Data2 : "+value2);
var sum = value1+value2;
var diff = value1-value2;
var prod = value1*value2;
var res = value1/value2;
var rem = value1%value2;
document.write("<br><br>The Sum of Data1 and Data2 : "+sum);
document.write("<br>The Difference of Data1 and Data2 : "+diff);
document.write("<br>The Product of Data1 and Data2 : "+prod);
document.write("<br>The Result after Division of Data1 and Data2 : "+res);
document.write("<br>The Remainder after Division of Data1 and Data2 :
"+rem);
</script>
</Body>
</Html>

```

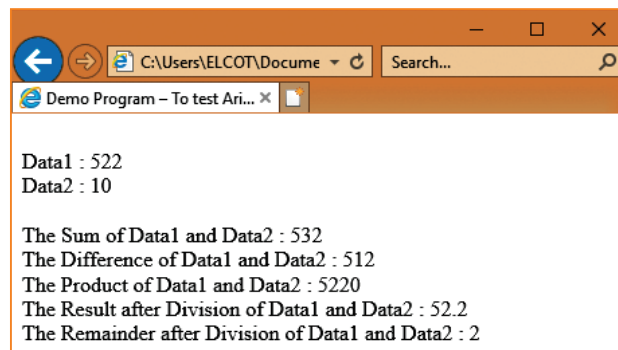
**Output:****14.6.2 Assignment Operator**

An assignment operator is the operator used to assign a new value to a variable. Assignment operator can also be used for logical operations such as bitwise logical operations or operations on integral operands and Boolean operands.

In JavaScript = is an assignment operator, which is used to assign a value to a variable. Often this operator is used to set a variable to a literal value, for example,

```

var number1=10;
var number2=number1;
var name="Computer Science";
var booleanvar=true;

```

The assignment operator is used to assign a value to a single variable, but it is possible to perform multiple assignments at once by stringing them together with the = operator. For example, the statement

**var m = n = z = 25; // sets all three variables to a value of 25//**

The assignment operator can also be used to set a variable to hold the value of an expression. For example,

**var x = 102 + 5 - 50; // x set to 57 //**

JavaScript supports some shorthand arithmetic operators like +=, -=, \*=, /= and %= to evaluate arithmetic calculations.

Table: 14.2 Shorthand Arithmetic operators

Shorthand Arithmetic Operator	Meaning	Example	Result
+=	Add and assign	var sum = 120; sum += 20;	Variable sum = 140
-=	Subtract and assign	var diff = 120; diff -= 20;	Variable diff = 100
*=	Multiply and assign	var prod = 100; prod *=10;	Variable prod = 1000
/=	Division	Var res = 522; Res/=100	Variable res = 5.22
%=	Modulus operator	Var rem = 522; rem %= 100	Variable rem = 22 (remainder)

#### Illustration 14.4 Using Arithmetic Shorthand Operators

```
<Html>
  <Head>
    <Title>Demo Program - To test Arithmetic Shorthand Operators in JavaScript
  </Title>
  </Head>
</Html>
<Head>
  <Title>Demo Program - To test Arithmetic Shorthand Operators in JavaScript
</Title>
</Head>
<Body>
  <script language="javascript" type="text/javascript">
    var value1 = 522, value2=10;
    document.write("<br>Data1 : "+value1);
    document.write("<br>Data2 : "+value2);
    var sum = value1; sum+=value2;
    var diff = value1; diff-=value2;
    var prod = value1; prod*=value2;
    var res = value1; res/=value2;
```

```

var rem = value1; rem%=value2;
document.write("<br><br>The Sum of Data1 and Data2 Using += : "+sum);
document.write("<br>The Difference of Data1 and Data2 Using -= : "+diff);
document.write("<br>The Product of Data1 and Data2 Using *= : "+prod);
document.write("<br>The Result after Division of Data1 and Data2 using /= : "+res);
document.write("<br>The Remainder after Division of Data1 and Data2 Using %= : "+rem);
</script>
</Body>
</Html>

```

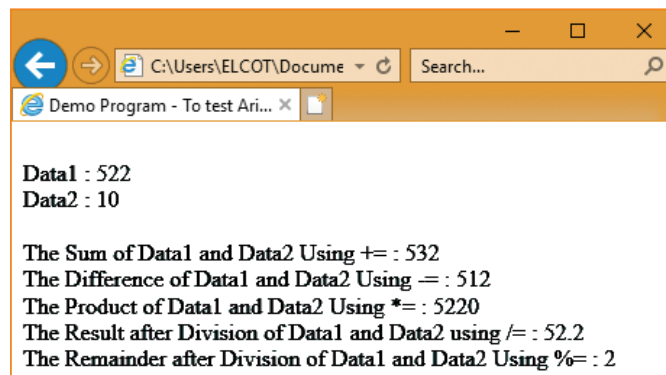
**Output:****Assignment:****Develop JavaScript code for the following:**

1. To find Simple Interest for the given Principle, Number of years and Rate of interest.
2. To find Compund Interest for the given Principle, Number of years and Rate of interest.
3. To find difference between Simple Interest and Compound Interst.

**14.6.3 Relational or Comparison Operators:**

Relational operators are also called as Comparison operators, they compares two values and the result is true or false. JavaScript provides a rich set of relational operators including == (equal to), != (not equal to), < (less than), > (greater than), <= (less than or equal to), and >= (greater than or equal to). Using a relational operator in an expression causes the expression to evaluate as true if the condition holds or false if otherwise.

Table: 14.3 Relational or Comparison operators

Relational (Comparison) Operator	Meaning	Example	Result
Assume x=10 and y=20			
==	Equality	x==y	False
!=	In-equality	x!=y	True
<	Less-than	x<y	True
>	Greater-than	x>y	False
<=	Less-than or equal to	x<=y	True
>=	Greater-than or equal to	x>=y	False

**Illustration 14.5 Using Relational Operators**

```

<Html>      <Head>
<Title>Demo Program - To test Relational(Comparison) Operators in JavaScript </Title>
</Head>      <Body>
      <script language="javascript" type="text/javascript">
var value1 = 522, value2=10;
document.write("<br>Data1 : "+value1);
document.write("<br>Data2 : "+value2);
document.write("<br><br>Whether Data1 = Data2 : "+(value1==value2));
document.write("<br>Whether Data1 < Data2 : "+(value1<value2));
document.write("<br>Whether Data1 > Data2 : "+(value1>value2));
document.write("<br>Whether Data1 <= Data2 : "+(value1<=value2));
document.write("<br>Whether Data1 >= Data2 : "+(value1>=value2));
document.write("<br>Whether Data1 != Data2 : "+(value1!=value2)); </script>
</Body> </Html>

```

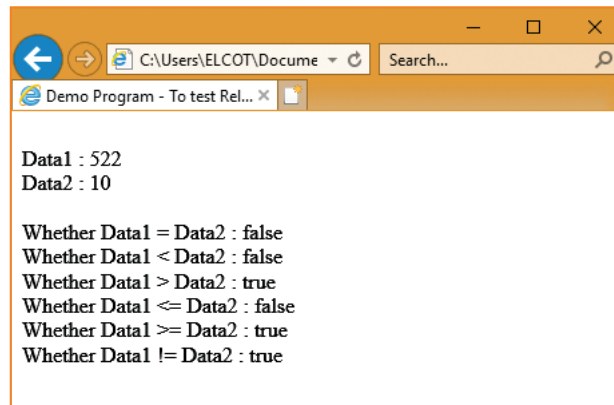
**Output:****14.6.4 Logical Operators:**

Logical operators perform logical (boolean) operations. Logical operators combine or invert boolean values. Once comparisons are made, the logical operators && (AND), || (OR) and ! (NOT) can be used to create more complex conditions.

Table: 14.4 Logical or Boolean operators

Logical Operator	Example	Meaning	Result
&&	((4<5) && (10>5)) ((expr1) && (expr2))	(Logical AND) Returns true if expr1 and expr2 both true.	True
	((4<5)    (10>5)) ((expr1)    (expr2))	(Logical OR) Returns true if either expr1 or expr2 is true, or both are true.	True
!	!(10>5) !(expr1)	(Logical NOT) Returns true if expr1 is false; otherwise, returns false.	False

**Usage :**

Best practice is to use logical operators on boolean operands. However, operands of any type can be combined. The strict rules are as follows:

- For && (AND) the result is false if the first operand is false; otherwise, the result is the Boolean value of the second operand.
- For || (OR) the result is true if the first operand is true; otherwise, the result is the Boolean value of the second operand.
- For ! (NOT) the result is true if the operand is false; otherwise, the result is true.

**Illustration 14.6 Using Logical Operators**

```
<Html>
<Head>
  <Title>Demo Program - To test Logical Operators in JavaScript </Title>
</Head>
<Body>
<script language="javascript" type="text/javascript">
  var value1 = 522, value2=10;
  document.write("<br>Data1 : "+value1);
  document.write("<br>Data2 : "+value2);
  var res1=((value1>100) && (value1>601));
  var res2=((value1>100) || (value1>601));
  var res3=(!(value1!=value2));
  document.write("<br><br>Whether Data1>100 AND Data1>601 : "+res1);
  document.write("<br><br>Whether Data1>600 OR Data1>601 : "+res2);
  document.write("<br>Whether !Data1 != Data2 : "+res3);
</script>
</Body>
</Html>
```

**Output:**

```

Data1 : 522
Data2 : 10

Whether Data1>100 AND Data1>601 : false

Whether Data1>600 OR Data1>601 : true
Whether !Data1 != Data2 : false

```

### 14.6.5 String Operators:

One of the built-in features of JavaScript is the ability to concatenate strings. The + operator performs addition on numbers but also serves as the concatenation operator for strings. Because string concatenation has precedence over numeric addition, + will be interpreted as string concatenation if any of the operands are strings. + operator which is also called as the string concatenation operator. For example:

#### Illustration 14.7 Using + Operator for concatenating String

```
<Html>
<Head>
  <Title>Demo Program - To Concatenating (+) Operators in JavaScript </Title>
</Head>
<Body>
  <script language="javascript" type="text/javascript">
    var String1 = "Java";
    var String2 = "Script";
    var String3=String1+String2;
    document.write("<br>String1 : "+String1);
    document.write("<br>String2 : "+String2);
    document.write("<br><br>Concatenated String of String1 and String2 : "+String3);
  </script>
</Body>
</Html>
```

#### Output:

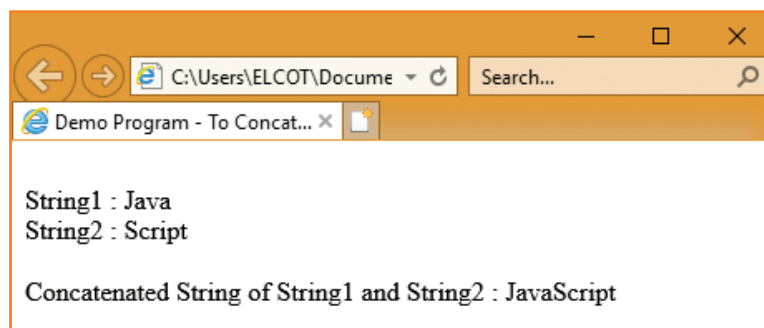

### 14.6.6 Increment and Decrement Operators:

The ++ operator increments its single operand. The operator converts its operand to a number, adds 1 to that number, and assigns the incremented value back into the variable. The return value of the ++ operator depends on its position relative to the operand. When ++ is used before the operand, where it is known as the pre-increment operator, it increments the operand and evaluates to the incremented value of that operand. When used after the operand, where it is known as the post-increment operator, it increments its operand but evaluates to the un-incremented value of that operand. Consider the difference between these two lines of code:

```
var m = 1, n = ++m; // m and n are both 2
```

```
var m = 1, n = m++; // m is 2, n is 1
```

The -- operator decrements its single operand. It converts the value of the operand to a number, subtracts 1, and assigns the decremented value back to the operand. Like the ++ operator, the return value of -- depends on its position relative to the operand. When used before the operand, it decrements and returns the decremented value. When used after the operand, it decrements the operand but returns the undecremented value.

```
var m = 2, n = --m; // m and n are both 1
```

```
var m = 2, n = m--; // n is 2, m is 1
```

#### Illustration 14.8 Using ++ and -- Operator – both Prefix and Suffix

```
<Html>
<Head>
  <Title>Demo Program - ++ and -- Operators in JavaScript </Title>
</Head>
<Body>
  <script language="javascript" type="text/javascript">
    var number1 = 150;
    var number2 = number1++;
    document.write("<br><h4>Post Increment - number++</h4>");
    document.write("Number1 = "+number1+" Number2 = "+number2);
    document.write("<br><h4>Pre Increment - ++number</h4>");
    var number1 = 150;
    var number2 = ++number1;
    document.write("Number1 = "+number1+" Number2 = "+number2);
    var number1 = 150;
    var number2 = number1--;
    document.write("<br><h4>Post Decrement - number--</h4>");
    document.write("Number1 = "+number1+" Number2 = "+number2);
    document.write("<br><h4>Pre Decrement - --number</h4>");
    var number1 = 150;
    var number2 = --number1;
    document.write("Number1 = "+number1+" Number2 = "+number2);
  </script>
</Body>
</Html>
```



**Output:**

```

Post Increment - number++
Number1 = 151 Number2 = 150
Pre Increment - ++number
Number1 = 151 Number2 = 151
Post Decrement - number--
Number1 = 149 Number2 = 150
Pre Decrement - --number
Number1 = 149 Number2 = 149

```

**14.6.7 Unary + and - Operator:**

+ has no effect on numbers but causes non-numbers to be converted into numbers

- Negation (changes the sign of the number or converts the expression to a number and then changes its sign)

**14.6.8 typeof Operator:**

The **typeof** operator is used to get the data type (returns a string) of its operand. The operand can be either a literal or a data structure such as a variable, a function, or an object. The operator returns the data type.

**Syntax**

**typeof operand**

**or**

**typeof(operand)**

typeof returns: boolean, function, number, string, and undefined. The following table summarizes possible values returned by the typeof operator.

**Table: 14.5**

Type of Operand	Result
Number	"number"
Boolean	"Boolean"
String	"string"
Functions	"function"
Undefined	"undefined"

**Illustration 14.9 typeof operator**

```

<Html>
<Head>
  <Title>Demo Program - To test typeof Operator in JavaScript </Title>
</Head>
<Body>
  <script language="javascript" type="text/javascript">
    var value1 = 522, value2="JavaSript"; value3=true;
    document.write("<br>Value1 =" +value1+" and its data Type is : "+typeof(value1));
    document.write ("<br>Value2 =" +value2+" and its data Type is : "+typeof(value2));
    document.write ("<br>Value3 =" +value3+" and its data Type is : "+typeof(value3));
  </script>
</Body>
</Html>

```

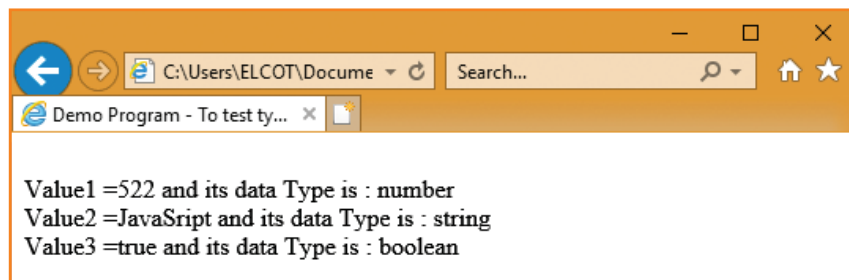
**Output:****14.6.9 Conditional Operator (?:)**

The `?:` is the conditional operator in JavaScript, which requires three operands, hence it is called the ternary operator. The syntax is

**var variablename=(condition) ? value1 : value2;**

In the syntax condition may be relational expression or logical expression. First condition will be evaluated, if the condition returns true then the value of the left side of the colon is assigned to the variable otherwise the value of the right side of the colon will be assigned the variable. For example,

```
var result=(10>15) ?100 :150;
```

In the above example, since the condition returns false the value 150 will be assigned to result.

**Illustration 14.10 Conditional Operator**

```

<Html>
<Head>
  <Title>Demo Program - To test Conditional Operator in JavaScript </Title>
</Head>
<Body>
  <script language="javascript" type="text/javascript">
    var value1 = 522, value2=150, value3;
    value3=(value1<value2) ? value1: value2;
    document.write("<br>The Value of Data1 = "+value3);
  </script>
</Body>
</Html>

```

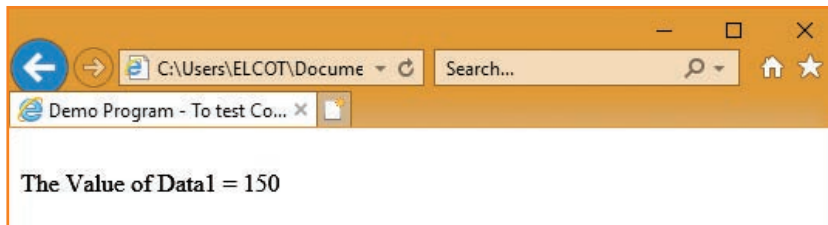
**Output:****14.7 JavaScript Popup or Dialog Boxes:**

JavaScript supports three important types of dialog boxes. Dialog boxes are also called as Popup Boxes. These dialog boxes can be used to raise an alert, or to get confirmation on any input or to have a kind of input from the users. JavaScript supports three kind of popup boxes: Alert box, Confirm box, and Prompt box.

**14.7.1 Alert Dialog Box:**

An **alert dialog box** is mostly used to give a warning message to the users. For example, if one input field requires to enter some text but the user does not provide any input, then as a part of validation, you can use an alert box to give a warning message. Alert box gives only one button "OK" to select and proceed.

**The syntax of alert box is**

```
Alert("Message");
(or) Window.alert("Message");
```

Example:

```
alert("Name is compulsory entry");
(or) window.alert("Name is compulsory entry");
```

**Illustration 14.11** Alert Dialog Box

```

<Html>
<Head>
  <Title>Demo Program - To test Alert Dialog Box in JavaScript </Title>
</Head>
<Body>
  <script language="javascript" type="text/javascript">
    var value1 = 522, value2=10;
    window.alert("Data1 : "+value1);
    alert("Data1 :"+value2);
  </script>
</Body>
</Html>

```

Output:

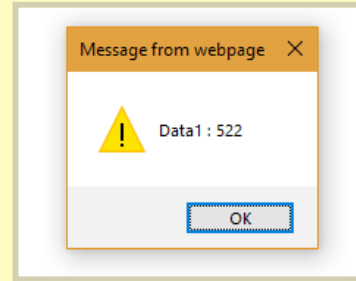
**14.7.2 Confirm Dialog Box:**

A confirmation dialog box is mostly used to take user's consent on any option. It displays a dialog box with two buttons: **OK** and **Cancel**. If the user clicks on the **OK** button, the `confirm()` will return true. If the user clicks on the **Cancel** button, then `confirm()` returns false.

**The syntax of confirm dialog box is**

```

confirm("message");
      (or)
window.confirm("message");

```

Example:

```

confirm("Hai Do you want to continue.");
      (or)
window.confirm("Hai Do you want to continue.");

```

**Illustration 14.12** Confirm Dialog Box

```

<Html>
<Head>
  <Title>Demo Program - To test Confirm Dialog Box in JavaScript </Title>
</Head>
<Body>
  <script language="javascript" type="text/javascript">
    var value1 = 522, value2=10;
    window.confirm("Data1 : "+value1);
    confirm("Data2 :"+value2);
  </script>
</Body>
</Html>

```

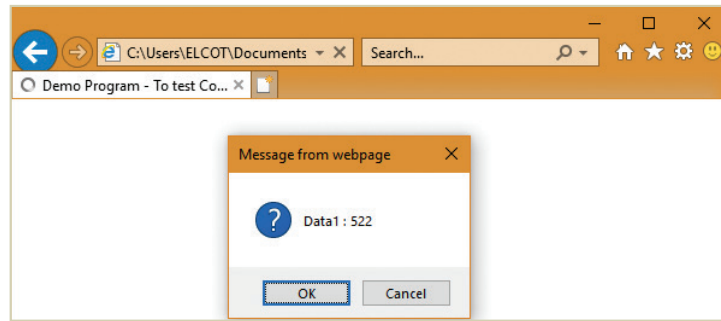
**Output:****14.7.3 Prompt Dialog Box:**

The prompt dialog box is very useful when the user want to pop-up a text box to get user input. Thus, it enables you to interact with the user. The user needs to fill in the text box field and then click OK.

The prompt dialog box is displayed using a method called `prompt()` which takes two parameters: (i) a label which you want to display in the text box and (ii) a default string to display in the text box. This dialog box has two buttons: OK and Cancel. If the user clicks the OK button, the `prompt()` will return the entered value from the text box. If the user clicks the Cancel button, the `prompt()` returns null. The Syntax of prompt dialog box is,

**Prompt("Message","default Value");**

(or)

**window.prompt("sometext", "defaultText");**

**Example:**

`prompt("Enter Your Name:","Name");`

(or)

`window.prompt("Enter Your Name:","Name");`

**Illustration 14.13 Prompt Dialog Box**

```
<Html>
<Head>
  <Title>Demo Program - To test Prompt Dialog Box in JavaScript </Title>
</Head>
<Body>
  <script language="javascript" type="text/javascript">
    var sname = prompt("Please enter your name", "Name");
  </script>
</Body>
</Html>
```

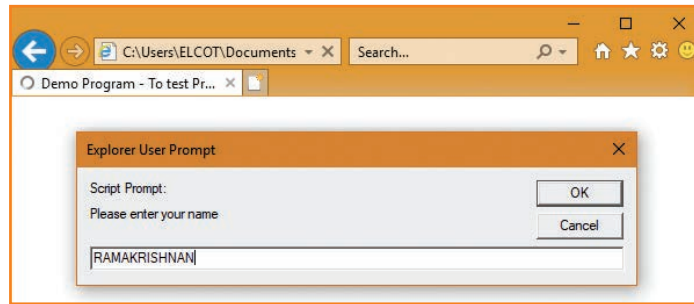
**Output:****14.8 Comments in JavaScript:**

Very important aspect of good programming style is to insert remarks and commentary directly in source code, making it more readable to yourself as well as to others. Any comments you include will be ignored by the JavaScript interpreter. There are two types of comments, **Single line** and **Multiple lines** comments. Single-line comments begin with a double slash (`//`), causing the interpreter to ignore everything from that point to the end of the line. Multiple line comments begins with `/*` and ends with `*/`.

**For example:**

```
// JavaScript single line comment//
```

Multiple line comments begins with `/*` and ends with `*/`

**Points to Remember:**

- The `<script>` tag alerts the browser program to start interpreting all the text between these tags as a script
- JavaScript is a case sensitive language
- The scope of a variable is the life time of a variable of source code in which it is defined
- A literal is a fixed value given to a variable in source code.
- An expression is a code fragment that can be evaluated to some data type the language supports.
- Java Script supports all basic arithmetic operators like `+`, `-`, `*`, `/` & `%`
- Java scripts has an in built feature of concatenating strings.
- The `typeof` operator is used to get the data type of a variable.
- JavaScript supports important types of dialog boxes also called as pop up boxes, alert box, confirm dialog box and prompt dialog box.
- `?:` is the conditional operator in Java Script also called as ternary operator.

## Evaluation



### Part-I

Choose the correct answer:

- Which provided a common scripting language to web developers to design, test and deploy Internet Application  
A) C    B) C++    C) Java    D) JavaScript
- Expand CGI  
A) Common Gateway Interface                          B) Complex Gateway Information  
C) Common Gateway Information                          D) Complex Gateway Interface
- JavaScript programming language is used to develop the  
A) Dynamic Web Page                  B) Window                  C) Web Page                  D) Home Page
- The Dynamic Web Page help to save server's  
A) Work    B) Route    C) Traffic    D) Pvath
- User entered data, is validated before sending it to server is called  
A) Server traffic    B) Dynamic Web Page  
C) Server Route    D) Web server
- Java Scripts can be implemented using which statements?  
A) <head>    B) <Java>    C) <script>    D) <text>
- Expand  
A) Distance Hyper Text Markup language                          B) Dynamic Hyper Text Markup language  
C) Distance High Text Markup language                          D) Dynamic High Text Markup language
- How many attributes specifies that <script> tag in the scripting  
A) 2    B) 3    C) 4    D) 5
- Which attribute is used to indicate the scripting language and its value should be sent to "Text/JavaScript"  
A) Language    B) Text1    C) Type    D) Body
- The file reload into the browser use the shortcut key is  
A) F2    B) F3    C) F4    D) F5
- JavaScript ignores spaces that appear between  
A) Command    B) Scripts    C) Tokens    D) Text
- A Data value for variable that appears directly in a program by using a  
A) loop    B) Literal    C) Statement    D) Text
- Which is mostly used to give a warning message to users?  
A) Alert Dialog Box    B) Confirm box  
C) Prompt box    D) Display box

14. In the below snippet, value of x is `var x = 250 + 2 - 200;`  
A) 50                      B) 52                      C) 48                      D) 42

### Part - II

#### Very Short Answers

1. Write a syntax of <script> tag
2. What is scope of variables and types of scope variable?
3. Write a notes to type casting in JavaScript
4. How many Literals in JavaScript and mention its types.
5. What is conditional operator give suitable example.
6. What are the comments in Java Script?
7. Write note on types of Operator.
8. Write the role of variable in JavaScript.
9. What is the uses of prompt dialog box?

### Part-III

#### Short Answers

1. What are the advantages of programming language?
2. Brief the basic data types in Java Scripts.
3. Write note on string Operator.
4. Write about <script> tag
5. What are the uses of Logical Operators?
6. Difference between the increment and Decrement operator.

### Part -IV

#### Explain in Detail

1. Explain about the popup dialog boxes in JavaScript.
2. Explain about the Arithmetic operator with suitable example.

#### Case study:

Develop a program for online registration form with some of the client side validation features

#### Reference :

1. Title - Pure JavaScript Author : R.Allen Wyke, Jason D. Gilliam and Charlton Ting, Publisher : Techmedia
2. Computer Application Text Book – Govt. of Kerala



## Control Structure in JavaScript

## Learning Objectives:

- To learn about control structures
- To learn about logical operators in JavaScript
- To learn about loops and their types
- To acquire knowledge of developing JavaScript programs.



## 15.1 Conditional Statements in JavaScript:

Statements are executed in the order they are found in a script. Conditional statements execute or skip one or set of statements depending on the value of a specified conditional expression. There are two types of controls,

- Branching / Selection
- Looping / repetitive

## 15.1.1 Branching Statements:

JavaScript supports branching statements which are used to perform different actions based on different conditions. Branching is a transfer of control from the current statement to another statement or construct in the program unit. A branch alters the execution sequence. There are different branching statements. They are,

- **if** statement
- **if ... else** statement
- **else if** statement
- **switch** statement

## 15.1.1.1 if and if..else Statement:

The **if** statement is the fundamental control statement that allows JavaScript to make decisions to execute statements conditionally. This statement has two forms. The form is for only true condition. The syntax is

```
if (condition)
{
    True block;
}
```

In the **if** form, condition contains relational/logical expression is evaluated. If the resulting value is true the true block is executed. True block may contain one or more than one statement. For example

### Illustration 15.1 Demo to Test if command

```

<Html>
<Head>
  <Title>Demo Program - To test if command in JavaScript </Title>
</Head>
<Body>
  <script language="javascript" type="text/javascript">
    var age = prompt("Please enter your Age :", "0");
    if(age>=16)
    {
      alert("You Are Eligible to Vote ....");
    }
  </script>
</Body>
</Html>

```

The output will be

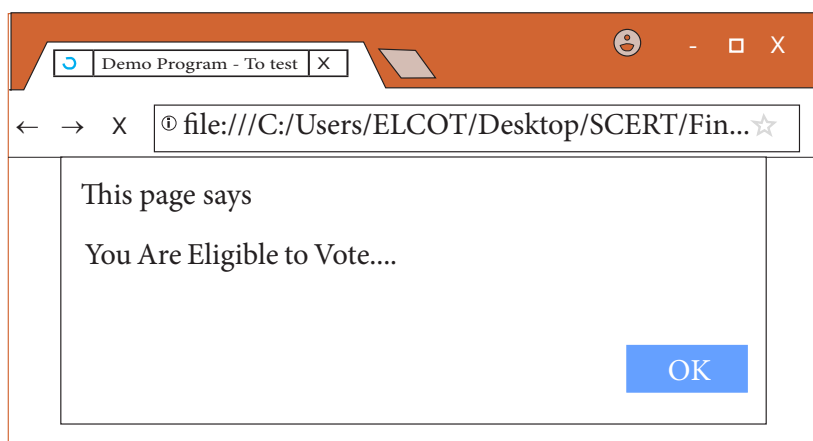
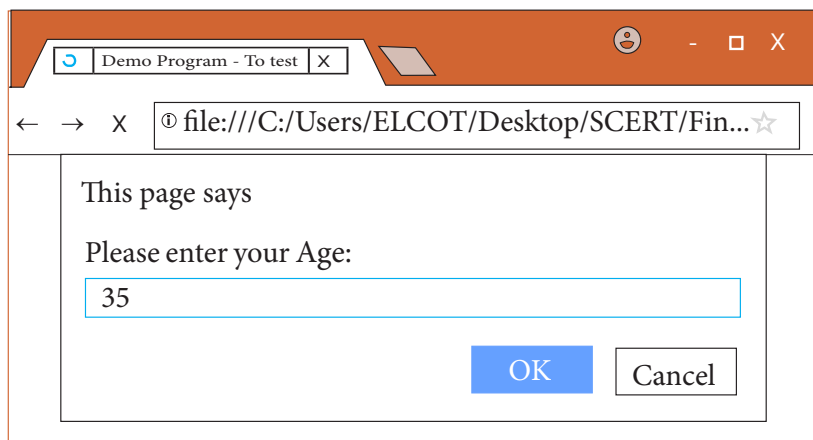

The second form of the **if** statement is an **else** clause that is the program to follow either of two branches depending on the condition. In the simple if construction, no special processing is performed when the condition evaluates to false. But if processing must follow one of two paths, hence need to use **if...else** format. Its **syntax** is:

```

if (expression)
  { statements if true }
else
  { statements if false }

```

This form is similar to if statement but the only difference is the **else** keyword, which provides an alternate path for execution to follow if the condition evaluates to false.

### Illustration 15.2 Using if.. else statement

```

<Html>
<Head>
  <Title>Demo Program - To test if..else command in JavaScript </Title>
</Head>
<Body>
  <script language="javascript" type="text/javascript">
    var age = prompt("Please enter your Age :", "0");
    if(age>=18)
    {
      alert("You Are Eligible to get Driving Licence..");
    }
    else
    {
      alert("You Are Not Eligible to get Driving Licence..");
    }
  </script>
</Body>
</Html>

```

The output will be

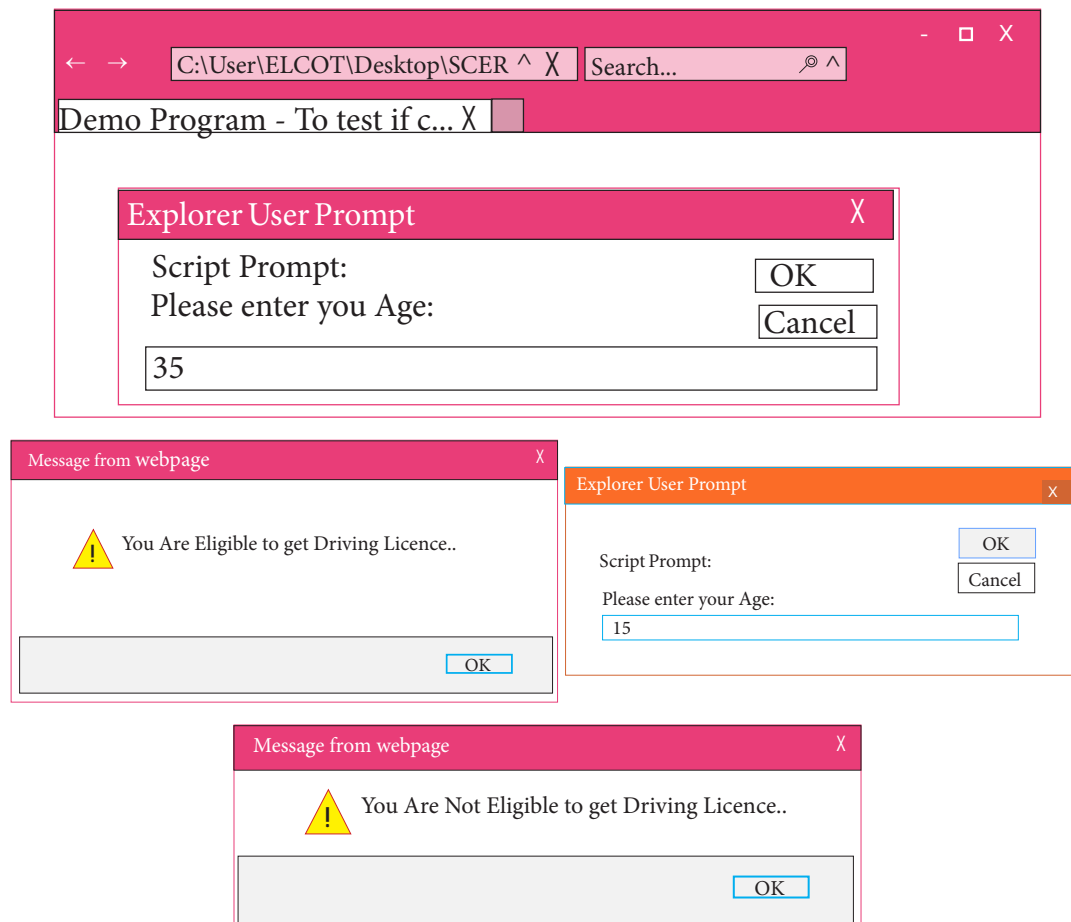

### 15.1.1.2 else if Statement:

The **if ... else** statement evaluates an expression and executes one of two pieces of code, depending on the outcome. The **else if** statement to specify a new condition if the first condition is false.

```

if (n == 10)
{           // Execute code block #1   }
else if (n == 20)
{           // Execute code block #2   }
else if (n == 30)
{           // Execute code block #3   }
else
{           // If all else fails, execute block #4 }

```

#### Illustration 15.3 Using Logical Operators and else if Statement

```

<Html>
<Head>
  <Title>Program - To test else ..if command in JavaScript </Title>
</Head>
<Body>
<script language="javascript" type="text/javascript">
  var marks = prompt("Please enter your Marks/100 :", "0");
  if(marks>90)
  {    document.write("Your Grade is Outstanding.."); }
  else if((marks>70) && (marks<=90))
  {    document.write("Your Grade is Excellent..");   }
  else if((marks>50) && (marks<=70))
  {    document.write("Your Grade is Good..");        }
  else if((marks>40) && (marks<=50))
  {    document.write("Your Grade is Satisfactory.."); }
  else
  { document.write("Your Grade Poor and have to re-appear Exam.."); }
</script>  </Body>  </Html>

```

The output will be

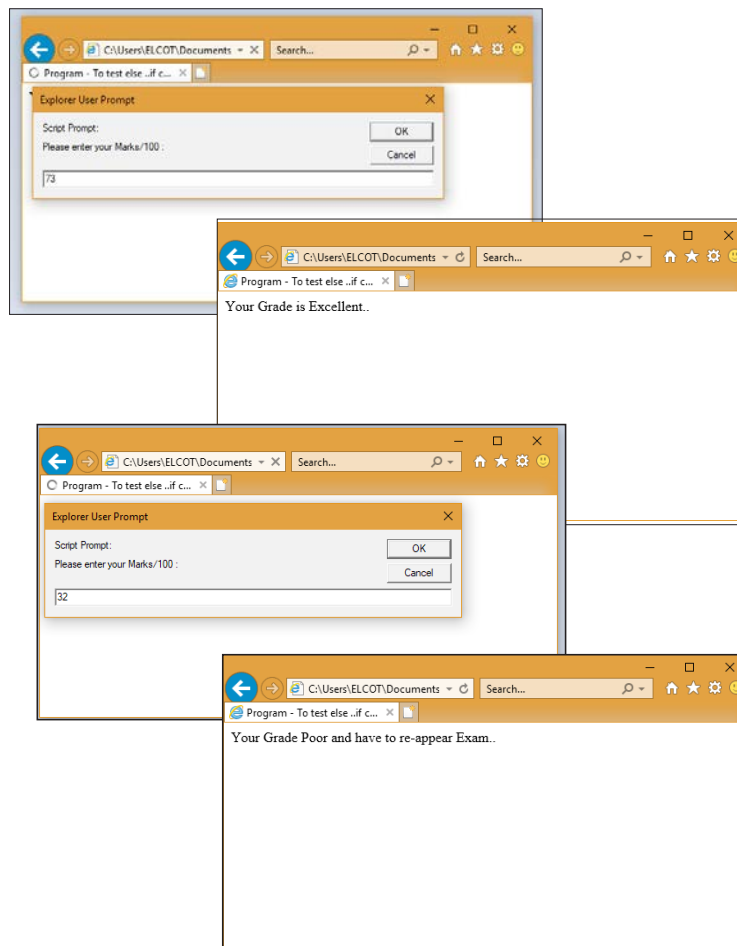

There is nothing special about this code. It is just a series of **if** statements, where each following **if** is a part of the **else** clause of the previous statement. Using the else if idiom is preferable to, and more legible than, writing these statements out in their syntactically equivalent, fully nested form:

```

if (n == 10)
{    // Execute code block #1    }
else
{
    if (n == 20)
    {    // Execute code block #2    }
    else
    {
        if (n == 30)
        {    // Execute code block #3    }
        else
        {    // If all else fails, execute block #4    }
    }
}
}

```

### 15.1.1.3 switch case Statement:

JavaScripts offers the **switch** statement as an alternate to using **if...else** structure. The switch statement is especially useful when testing all the possible results of an expression. The syntax of a switch structure as the following:

```
switch(expression)
{
    case label1:
        statements1;
        break;
    case label2:
        statements2;
        break;
    case labeln;
        statements - N;
        break;
    default:
        statements;
}
```

### 15.1.1.4 Break and Default Statement

The switch statement begins by evaluating an expression placed between parenthesis, much like the if statement. The result compared to labels associated with case structure that follow the switch statement. If the result is equal to a label, the statements in the corresponding case structure are executed. The **default** structure is can be at the end of a switch structure if the result of the expression that do not match any of the case labels. The **break** statement is also used commonly within switch to exit the statement once the appropriate choice is found.

#### Illustration 15.4 Using Switch Statement

```
<Html>
    <Head>
    <Title>Program - To test witch command in JavaScript </Title>
    </Head>
    <Body>
    <script language="javascript" type="text/javascript">
    var grade=0;
    var marks=prompt("Please enter your marks/100:");
    if(marks>90)
    {grade=1;}
    else if(marks>70)&&(marks<=90)
    {grade=2;}
    else if(marks>50)&&(marks<=70)
    {grade=3;}
    </script>
    </Body>
</Html>
```

```

else if(marks>40v)&&(marks<=50)
{grade=4;}
else
{grade=5;}
switch(grade)
{
case 1:
document.write("Your Grade is Outstanding..");
    break;
case 2:
document.write("Your Grade is Excellent..");
    break;
case 3:
document.write("Your Grade is Good..");
    break;
case 4:
document.write("Your Grade is Satisfactory..");
    break;
default:
document.write("Your Grade Poor and have to re-appear Exam..");
}
</script>
</Body>
</Html>

```

The output will be

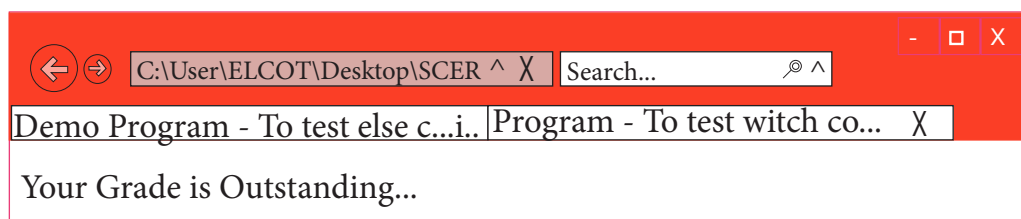
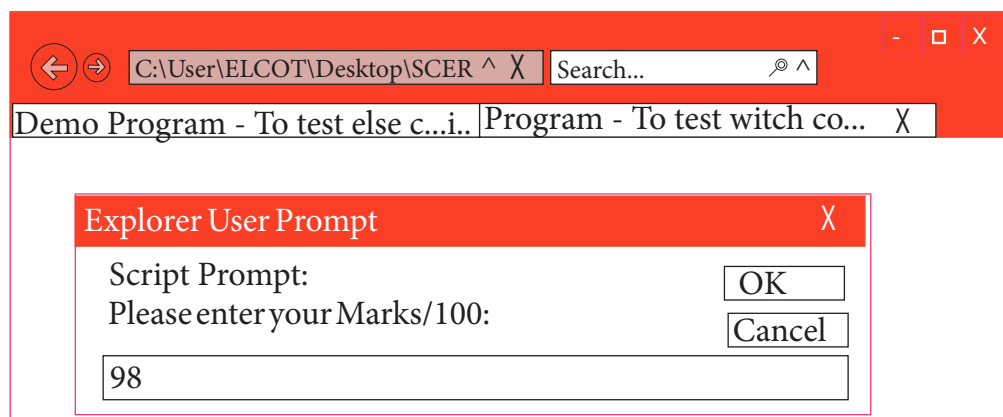

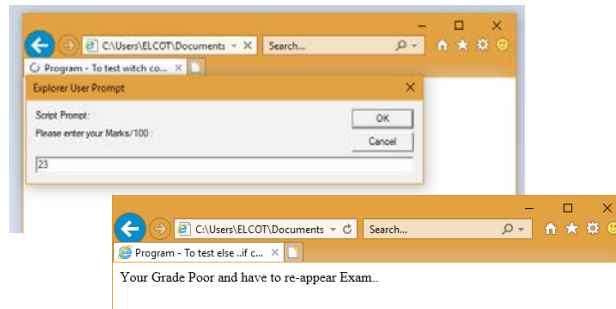

## 15.2 Looping / repetitive

In JavaScript there are times when the same portion of code needs to be executed many times with slightly different values is called Loops. JavaScript supports three kinds of looping statements. They are

- **for** loop
- **while** loop
- **do..while** loop

### 15.2.1 for loop

The **for** loop is a very rigid structure that loops for a pre-set number of times. In JavaScript **for** structure is very flexible, which makes this type is very useful. The syntax of the **for** loop looks like the following:

**for(initialization; condition; increment/decrement)**

```
{
    Body of the loop;
}
```

The for structure within parenthesis there are three parts each separated by semicolon. They are,

1. The first part of the loop initialize a variable which is also called as control variable. In most case the control variable is declared as well as initialized.
2. The second part is the conditional statement that determines how many times the loop will be iterated.
3. The third and final part determines how the value of control variable is changed (Incremented/Decrement)



### Illustration 15.5 Using for loop

```

<Html>
<Head>
  <Title> Program - To test for statement in JavaScript </Title>
</Head>
<Body>
  <script language="javascript" type="text/javascript">
    var no1 = prompt("Please enter Table You want :", "0");
    document.write("<h2> Multiplication for your need </h2>");
    for( var no2=0;no2<=10;no2++)
    {
      document.write(no1+" x "+no2+" = "+no1*no2+"<br>");
    }
  </script>
</Body>
</Html>

```

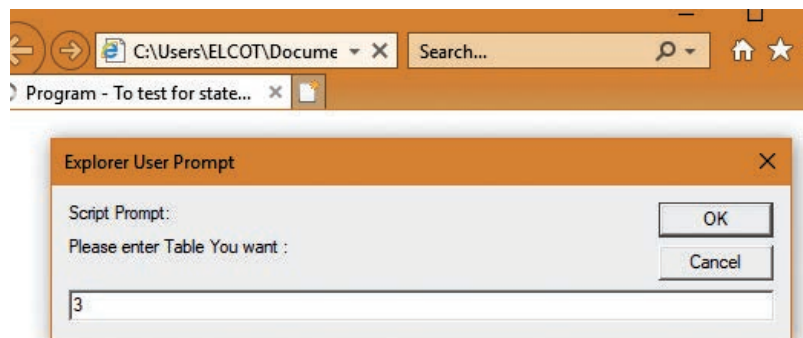

### 15.2.2 break and continue statement

JavaScript also supports statements used to modify flow control, specifically **break** and **continue**. The **break** statement will terminate the loop early. For example,

```
for(var n=0;n<=10;n++)
{
    if(n==5)
        { break;      }
    document.write(n+"<br>");
}
```

In the above example, which writes out the value of n starting from 0, when n is equal to 5 the break statement is executed and the loop is terminated and the output is as follows,

#### Illustration 15.6 Using break statement

```
<Html>
<Head>
  <Title>Demo Program - To test Break command in JavaScript </Title>
</Head>
<Body>
  <script language="javascript" type="text/javascript">
    document.write("<h2> Using Break Statement </h2>");
    for( var no2=0;no2<=10;no2++)
    {
      if(no2==5)
        {break;}
      document.write(no2+" ");
    }
  </script>

</Body>
</Html>
```

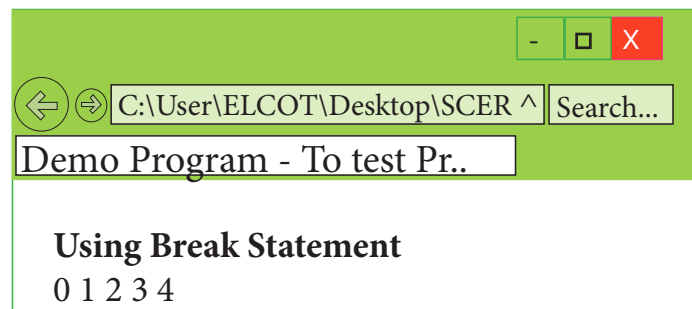

The **continue** statement will skip back to the loop condition check. When the **continue** statement is executed, the current iteration of the enclosing loop is terminated, and the next iteration begins. For example,

```

for(var n=0;n<=10;n++)
{
    if(n==5)
    {
        continue;
    }
    document.write(n+"<br>");
}

```

In the above example, which writes out the value of n starting from 0, when n is equal to 5 the continue statement is executed and the **continue** statement continues the loop without printing the value 5 and the output is as follows,

#### Illustration 15.7 Using continue statement

```

<Html>
<Head>
  <Title>Demo Program - To test Continue command in JavaScript </Title>
</Head>
<Body>
  <script language="javascript" type="text/javascript">
    document.write("<h2> Using continue Statement </h2>");
    for( var no2=0;no2<=10;no2++)
    {
      if(no2==5)
      {continue;}
      document.write(no2+" ");
    }
  </script>
</Body>
</Html>

```

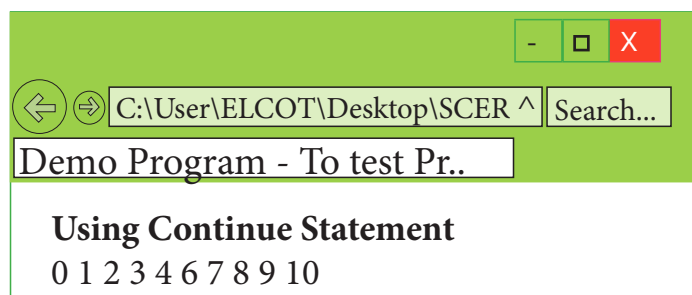

### 15.2.3 while loop

In JavaScript **while** loop is another most basic loop. The purpose of a **while** loop is to execute a statement /block of statement repeatedly as long as an expression is true.

The while statement creates a loop that executes a specified statement as long as the test condition evaluates to true. The condition is evaluated before executing the statement.

The syntax is:

```
while (condition)
{
    body of the loop
}
```

#### Illustration 15.8 Using while loop

```
<Html>
<Head>
    <Title>Program - To test while statement in JavaScript </Title>
</Head>
<Body>
    <script language="javascript" type="text/javascript">
        document.write("<h2> Using while Statement </h2>");
        var no2=0;
        while(no2<=5)
        {
            document.write(no2+" ");
            no2=no2+1;
        }
    </script>
</Body>
</Html>
```

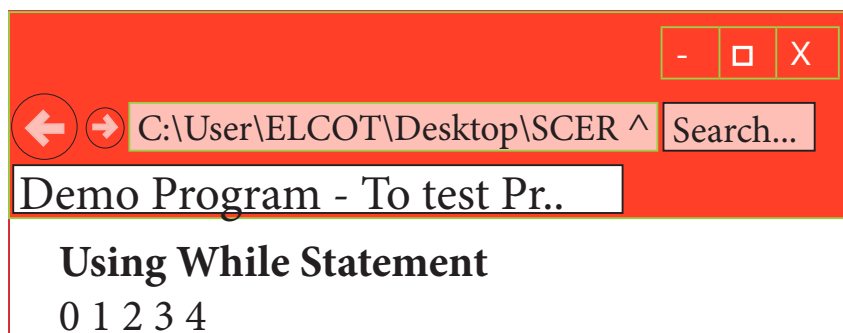

To execute a while statement, the interpreter first evaluates expression. If the value of the expression is true the interpreter executes the statement and repeats, jumping back to the top of the loop and evaluating expression again. In the above example let us see how the while command is executed,

1. Initial value of the variable no2 is set to 0
2. The expression in the while statement is executed
3. If the condition is true then body of the loop will be executed once otherwise body of the loop will be skipped and control will jump to next statement to end of the loop.
4. Then the value of the control variable is executed and control jumps to condition again go

to step 3

#### 15.2.4 do .. while loop

The **do..while** loop is like a while loop, except that the loop expression is tested at the end of the loop rather than at the beginning. This means that the body of the loop is always executed at least once. The syntax is:

```
do
{
    body of the loop
} while (expression);
```

An important difference between while and do..while statement is in the do..while loop body of the loop always executed at least once before the condition can be executed. In a while loop, first condition will be evaluated and then only based on the result of the condition the body of the loop will be executed or not.

#### Illustration 15.9 Using do..while loop

```
<Html>
<Head>
    <Title>Program - To test do..while statement in JavaScript </Title>
</Head>
<Body>
    <script language="javascript" type="text/javascript">
        document.write("<h2> Using do..while Statement </h2>");
        var no2=0;
        do
        {
            document.write(no2+" ");
            no2=no2+2;
        }while(no2<=10);
    </script>
</Body>
</Html>
```

#### Output:

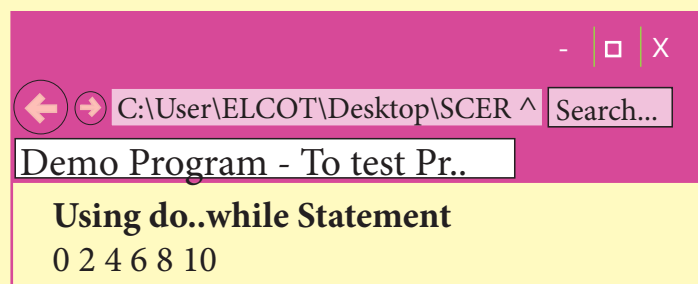

#### Exercise

Write a JavaScript Program for the following:

- To display Odd number from 1 to N numbers.
- To display any Multiplication table as the user required.
- To display as 10,9,8,.....0

### Points to Remember:

- Conditional Statements help to alter the normal sequence of execution of a program by two types of controls - Branching and Looping.
- The three logical operators in Java Script are &&, !! & !.
- The break statement is commonly used to exit the statement once the appropriate choice is found.
- The for is a very rigid, flexible structure that loops for a pre set number of times.
- The break statement terminates the loop irrespective of the condition and the continue statement executes the next iteration of the loop.

### Evaluation



#### Part-I

#### Choose the correct answers:

- Which conditional statement is used to transfer control from current statement to another statement?  
(a) Branching      (b) Sequencing      (c) Looping      (d) Interating
- \_\_\_\_\_ statement can be used as alternative to if-else statement.  
(a) While      (b) If      (c) Else-if      (d) Switch
- Which statement in switch case is used to exit the statement once the appropriate choice is found?  
(a) Exit      (b) Default      (c) Case      (d) Break
- Which of the following is not a looping statement?  
(a) Switch      (b) While      (c) Do-While      (d) For
- Which part of the loop statement determines the number of times, the loop will be iterated? (MOT)  
(a) First      (b) Second      (c) Third      (d) Final
- Which of the following is not a branching statement?  
(a) Loop      (b) If-else      (c) Switch      (d) For
- What will be the output for the following snippet:  
For (var n=0; n<10; n+1)  
{  
  if (n==3)  
  {  
    break;  
  }  
}

```
document.write(n+"<br>");
}
```

- (a) 0 1 2                      (b) 0 1 2 3                      (c) 0 1 2 3 4                      (d) 0, 1, 3
8. In which loop the condition is evaluated, before executing a statement? (MOT)  
 (a) While                      (b) Do while                      (c) Break                      (d) Continue
9. The \_\_\_\_\_ statement is especially useful when testing all the possible results of an expression. (LOT)  
 (a) While                      (b) Do while                      (c) Switch                      (d) If
10. In the \_\_\_\_\_ loop, body of the loop always executed at least once before the condition can be executed. (LOT)  
 (a) For                      (b) While                      (c) If                      (d) Do while
11. `<script type = "text / javascript">`  
`x = 6 + "3";`  
`document.write (x);`  
`</script>` what will be the output?  
 (a) 6                      (b) 9                      (c) 63                      (d) Error

## Part – II

### Very Short Answers

1. What are the different types of control statement used in JavaScript?
2. What is meant by conditional statements in JavaScript?
3. List out the various branching statements in JavaScript?
4. Write the general syntax for switch statement
5. Differentiate the break and continue statement.

## Part-III

### Short Answers

1. What is if statement and write its types.
2. Write the syntax for else-if statement.
3. What is called a loop and what are its types?
4. Differentiate between while and do while statements

5. What message will be displayed, if the input for age is given as 20, for the following snippet.

```
if (age >= 18 )
{
alert ("you are eligible to get Driving licence")
}
else
alert ("you are not eligible to get driving licence");
}
```

### Part –IV

#### Explain in Detail

1. Explain for loop with example
2. Explain switch case statement with example
3. Write the output for the following program

```
<Html>
<Head>
<Title> for statement</title>
<Head>
<Body>
<script language= "java Script" type = "text / javaScript">
var no1= prompt ("please enter table you want:", "0" );
document write ("<h2> multiplication for your need </h2>")
for (Var no2= 0; no2<=10; no2++)
{
document write (no1+ "x" + no2+ "=" + no1*no2+ "<br>");
}
</script>
</body>
</Html>
```

4. Write a Java Script program using while statement to display 10 numbers.



## JavaScript Functions

### Learning Outcomes

The students will learn the following:

- How to implement the function in JavaScript
- How to use Pre-defined functions
- How to create and use user-defined functions
- To create an Online application



### 16.1 Introduction

A function is a block of JavaScript code that is defined once but may be executed or invoked any number of times. Functions are used to encapsulate code that performs a specific task. Sometimes functions are defined for commonly required tasks to avoid the repetition entailed in typing the same statements over and over. More generally, they are used to keep code that performs a particular job in one place in order to enhance reusability and program clarity.

JavaScript functions are parameterized or non-parameterized. A parameterized function definition may include a list of identifiers, known as parameters that work as local variables for the body of the function. Function invocations provide values or arguments for the function's parameters. Functions often use their argument values to compute a return value that becomes the value of the function invocation expression.

JavaScript supports two types functions. They are

- Pre-defined or Library Functions
- User-defined Functions

### 16.2 Some common pre-defined functions.

Pre-defined functions are already defined in the JavaScript library which are also called Library functions. For example `isNaN()`, `toUpperCase()`, `toLowerCase()`, `length()`, `alert()`, `prompt()`, `write()` etc., are pre-defined functions.

Table: 16.1 Predefined functions

Function	Description	Example	Result
toUpperCase()	Used to convert given string into uppercase	x="java" x.toUpperCase();	JAVA
toLowerCase()	Used to convert given string into lowercase	x="JAVA" x.toLowerCase();	java
length	Used to find length of the given string	x="JAVA" x.length();	4
parseInt()	Used to convert the given float value into an integer	parseInt(34.234);	34
parseFloat()	Used to convert the given string into a integer	parseFloat("34.23");	34.23

### 16.3 User defined functions

User-defined functions allow the programmer to modularize a program. Most computer programs that solve real-world problems are much large, occupy more space in the computer memory and takes more time to execute. Hence such large programs are divided into small programs are called **modules**.

#### Function Definition

The format of a function definition is

```
Function function-name(parameters list)
{
  Declaration of variable
  Executable statements;
}
```

Function Body

#### Note:

- The function-name is any valid identifier.  
For Example: sum
- The parameter list contains one or more valid variable name.
- Parameter list contains more than one variable then comma must be there between the variable. For example: function sum(x,y)
- The function body must be enclosed by braces.

#### Example:

```
function sum(x,y)
{
    var m=x+y;
    return m;
}
```

**Listing 16.1 Using Function**

```

<html>
<head>
<title>Function Example</title>
<script type="text/JavaScript">
<!--
var input1=window.prompt("Enter Value1 :", "0");
var input2=window.prompt("Enter Value2 :", "0");
var v1=parseInt(input1);
var v2=parseInt(input2);
var s=sum(v1,v2);
document.writeln("<br><h4><u>Example for Function</u></h4>");
document.writeln("First No : " + v1 + " <br>Second No : " + v2 + " <br> The Sum = " + s);
function sum(x, y)
{
var s=x+y;
return s;
}
//-->
</script>    </head>    <body>    </body>    </html>

```

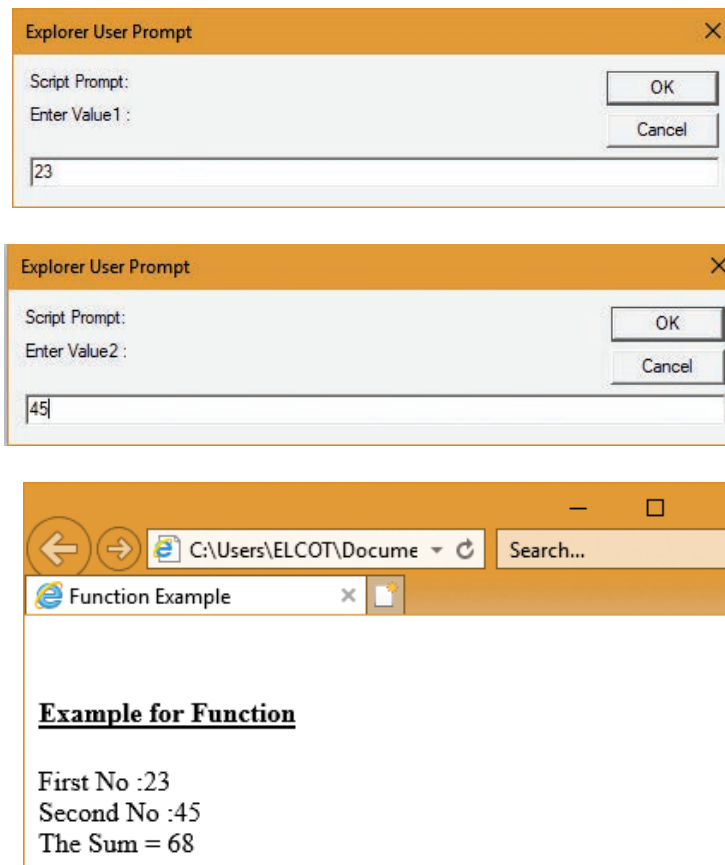
**Output:**

The isNaN() function is used to check whether the given value or variable is valid number. This function returns true if the given value is not a number. For example isNaN("12"), isNaN("A").

### Listing 16.2 Using isNaN() Function

```
<html>
<title>Example Program to test isNaN() Function</title>
<head> </head>
<body>
<h4><u>Example Program to test isNaN() Function</u></h4>
<script language="JavaScript">
function checknum()
{
var n=document.form1.text1.value;
if(isNaN(n)==true)
{ document.form1.text2.value="Not a Number : "+n; }
else
{ document.form1.text2.value="It is Number : "+n; }
}
</script>
<form name="form1">
Enter a Number1:
<input type="text" name="text1" size=3>
<br><br>
<input type="button" value="Click to Check" onClick="checknum()">
<input type="text" name="text2" size=30>
<br> </form> </body> </html>
```

### Output:

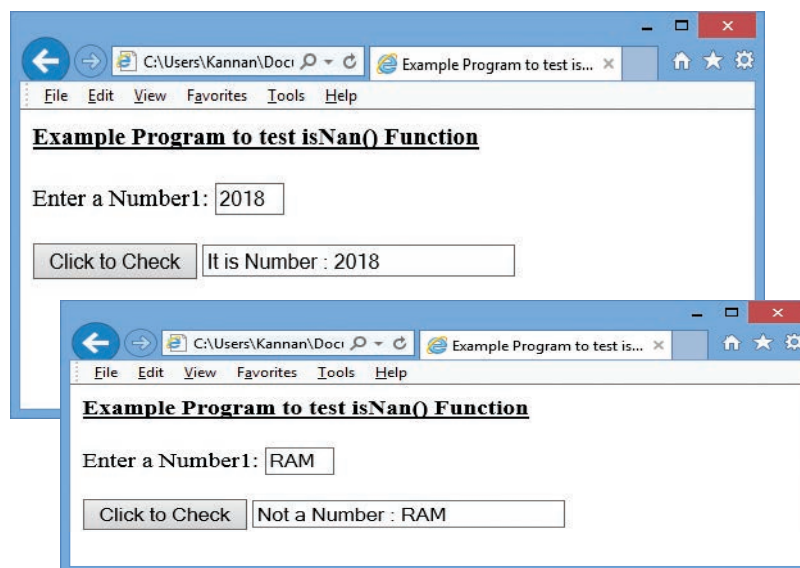

**Listing 16.3 Using Function (on-line quiz)**

```

<html>
<head>
<title>On-line Quiz</title>
<script type="text/JavaScript">
function checkAnswer()
{
    //var myQuiz=document.getElementById("myQuiz");
    if ( document.getElementById("myQuiz").elements[0].checked)
        alert("Congratulations, Your Answer is correct");
    else
        alert("Your Answer is incorrect, Please try Again");
}
</script>    </head>
<body>
<form id="myQuiz" action="JavaScript:checkAnswer()">
<p> Which is not a Programming Language: <br>
<input type="radio" name="radiobutton" value="Word" />
<label> MS-Word</label>
<input type="radio" name="radiobutton" value="Cobol" />
<label> COBOL</label>
<input type="radio" name="radiobutton" value="CPP" />
<label> C++</label>
<input type="radio" name="radiobutton" value="VB" />
<label>Visual BASIC</label><br><br>
<input type="submit" name="submit" value="Submit" />
<input type="reset" name="reset" value="Reset" />
</p> </form>    </body>    </html>

```

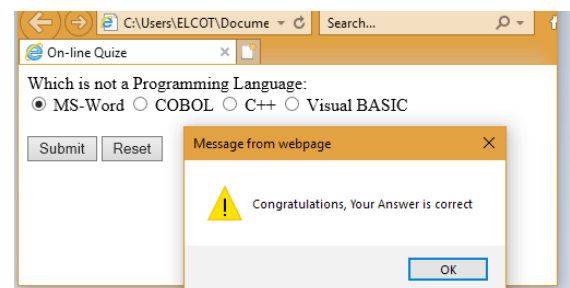
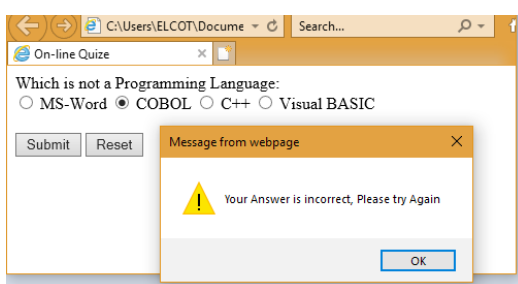
**Output:****Note:**

- The **getElementById()** method returns the element that has the ID attribute with the specified value. (In this example, ID is received from form tag).
- **elements[0]** indicates the first option given in the question (Ms-word)

### Points to Remember:

- A function is a block of JavaScript code that is defined once but can be invoked for any number of times.
- There are 2 types of functions predefined and user defined functions
- Predefined functions are also called Library function
- User defined functions allow the programmer to modularize a program
- Larger programs divided into smaller are called modules.

### Evaluation



#### Part-I

Choose the correct answer:

- The parameters work as
 

A) Local variable	B) Global Variable
C) File variable	D) block variable
- Predefined functions are also called as
 

A) Library functions	B) storage functions
C) instructions	D) commands
- Larger programs are divided into smaller are called
 

A) modules	B) block
C) sets	D) Group
- Which of the following is used to enhance reusability and program clarity.
 

A) functions	B) modules
C) sets	D) instructions
- Which of the following allow the programmer to modularize a program
 

A) Library functions	B) user defined functions
C) Normal functions	D) Ordinary functions

#### Part - II

#### Very Short Answers

- What is a function in JavaScript?
- What is the use of function?
- Write a note on Library functions.
- Write a note on user defined functions.
- Write the syntax of functions.

#### Part-III

#### Short Answers

- Write a program in JavaScript to find the cube of a number using function
- Write a program in JavaScript to find the sum of 10 numbers using function.

#### Case study

Display a menu as web page, Accept the choice as input and display the result using function.

The menu to be displayed is

- Sum of numbers upto a given limit
- Sum of numbers from a starting limit to ending limit.

## Computer Ethics and Cyber Security

### Learning Objectives

After learning this chapter, the students will be able to

- To know about cyber-crimes.
- To understand the guidelines and need for ethics in cyber-world.
- To understand issues related to cyber-crimes.
- To know the functionality of firewalls and proxy servers.
- To learn about encryption and decryption.
- To gain knowledge on IT Act.



### 17.1 INTRODUCTION

Internet is a communication media which is easily accessible and open to all. Information Technology is widespread through computers, mobile phones and internet. There is a lot of scope and possibility for misuse of Information Technology.

Computer systems in general are vulnerable. Special care must be taken explicitly in order to ensure that the valuable data do not get into wrong hands. Hence, the data need to be protected.

A cyber-crime is a crime which involves computer and network. This is becoming a growing threat to society.

### ETHICS

Ethics is a set of moral principles that govern the behavior of an individual in a society, and Computer ethics is set of moral principles that regulate the use of computers by users.

### GUIDELINES OF ETHICS

Generally, the following guidelines should be observed by computer users:

1. **Honesty:** Users should be truthful while using the internet.
2. **Confidentiality:** Users should not share any important information with unauthorized people.
3. **Respect:** Each user should respect the privacy of other users.
4. **Responsibility:** Each user should take ownership and responsibility for their actions



Ethics is a set of moral principles that govern the behavior of an individual in a society, and Computer ethics is set of moral principles that regulate the use of computers by users.

### 17.2 ETHICAL ISSUES

An Ethical issue is a problem or issue that requires a person or organization to choose between alternatives that must be evaluated as right (ethical) or wrong (unethical). These issues must be addressed and resolved to have a positive influence in society.

Some of the common ethical issues are listed below:

- Cyber crime
- Software Piracy
- Hacking
- Use of computers to commit fraud

- Sabotage in the form of viruses
- Making false claims using computers

**CYBER CRIME**

Cybercrime is an intellectual, white-collar crime. Those who commit such crimes generally manipulate the computer system in an intelligent manner.

For example – illegal money transfer via internet.

Examples of some Computer crimes and their functions are listed below in **Table 17.1:**

Table 17.1 Computer Crime

Crime	Function
Malware	Malicious programs that can perform a variety of functions including monitoring user’s computer activity without their permission.
Harvesting	A person or program collects login and password information from a legitimate user to illegally gain access to others’ account(s).
Spam	Distribute unwanted e-mail to a large number of internet users.

**SOFTWARE PIRACY**

Software Piracy is “unauthorized copying of software”.

**Figure 17.2** shows a diagrammatic representation of software piracy.

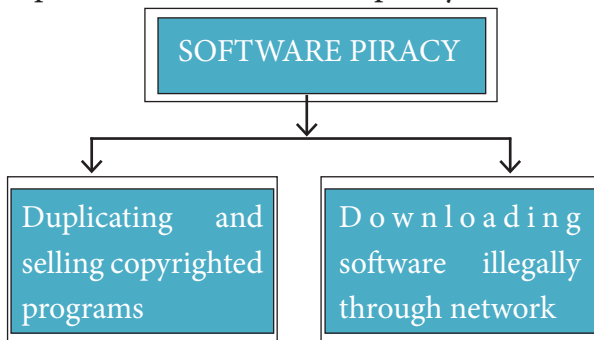

Figure 17.2- Diagrammatic representation of Software piracy

An entirely different approach to software piracy is called **Shareware**. Shareware publishers encourage users to give copies of programs to friends and colleagues but ask everyone who uses that program regularly to pay a registration fee to the program’s author directly. Commercial programs that are made available to the public illegally are often called **Warez**.

**HACKING**

Hacking is intruding into a computer system to steal personal data without the owner’s permission or knowledge (like to steal a password). It is also gaining unauthorized access to a computer system, and altering its contents. It may be done in pursuit of a criminal activity or it may be a hobby. Hacking may be harmless if the hacker is only enjoying the challenge of breaking systems’ defenses, but such ethical hacking should be practiced only as controlled experiments. **Figure 17.3** shows a diagrammatic representation of Hacking.

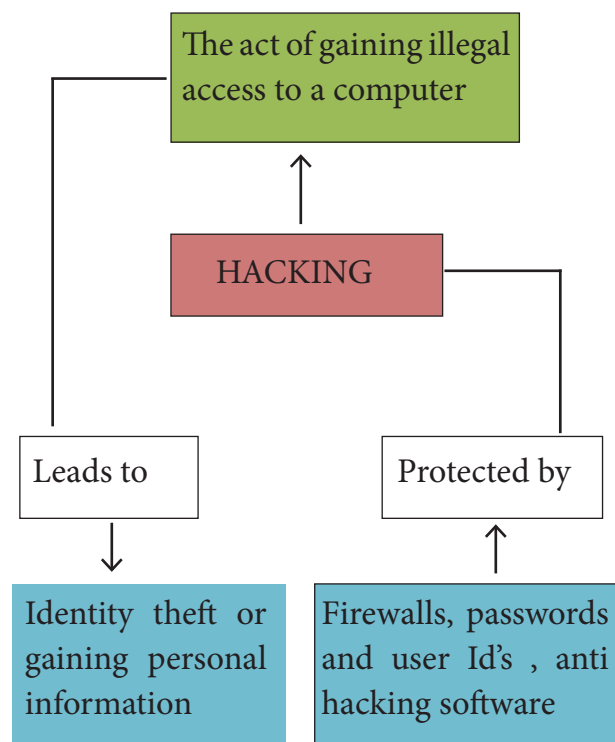

Figure 17.3 Diagrammatic representation of Hacking



To prevent unauthorized access, Firewalls, **Intrusion Detection Systems (IDS)**, Virus and Content Scanners, Patches and Hot fixes are used.

### CRACKING

Cracking is where someone edits a program source so that the code can be exploited or modified. A cracker (also called a black hat or dark side hacker) is a malicious or criminal hacker. “Cracking” means trying to get into computer systems in order to steal, corrupt, or illegitimately view data.

A cracker is someone who breaks into someone else's computer system, often on a network, bypassing passwords or licenses in computer programs.

They may send official e-mail requesting some sensitive information. It

may look like a legitimate e-mail from bank or other official institution.

### 17.3 Cyber Security and Threats

Cyber attacks are launched primarily for causing significant damage to a computer system or for stealing important information from an individual or from an organization. Cyber security is a collection of various technologies, processes and measures that reduces the risk of cyber attacks and protects organizations and individuals from computer based threats.

#### TYPES OF CYBER ATTACKS

Malware is a type of software designed through which the criminals gain illegal access to software and cause damage. Various types of cyber-attacks and their functions are given in **Table 17.2**.

Table 17.2 – Cyber Attacks and Functions

S.No.	Cyber Attack	Function
1.	Virus	A virus is a small piece of computer code that can repeat itself and spreads from one computer to another by attaching itself to another computer file. One of the most common virus is <b>Trojan</b> . A Trojan virus is a program that appears to perform one function (for example, virus removal) but actually performs malicious activity when executed.
2.	Worms	Worms are self-repeating and do not require a computer program to attach themselves. Worms continually look for vulnerabilities and report back to the author of the worm when weaknesses are discovered.
3.	Spyware	Spyware can be installed on the computer automatically when the attachments are open, by clicking on links or by downloading infected software.
4.	Ransomware	Ransomware is a type of malicious program that demands payment after launching a cyber-attack on a computer system. This type of malware has become increasingly popular among criminals and costs the organizations millions each year.

## Cyber Security Threats

In recent years, most of the individuals and enterprises are facing problems due to the weaknesses inherent in security systems and compromised organizational infrastructures. Different types of Cyber Security Threats are categorized as below:

### Phishing

Phishing is a type of computer crime used to attack, steal user data, including login name, password and credit card numbers e.t.c. through emails.

### Pharming

Pharming is a scamming practice in which malicious code is installed on a personal computer or server, misdirecting users to fraudulent web sites without their knowledge or permission. Pharming has been called "**phishing without a trap**". It is another way hackers attempt to manipulate users on the Internet. It is a cyber-attack intended to redirect a website's traffic to a fake site.

### Cookies

A cookie is a small piece of data sent from a website and stored on the user's computer memory (Hard drive) by the user's web browser while the user is browsing internet.

Web sites typically use cookies for the following reasons:

- To collect demographic information about who has visited the Web site.
- Sites often use this information to track how often visitors come to the site and how long they remain on the site.

### Firewall and Proxy Servers

A firewall is a computer network security based system that monitors and controls incoming and outgoing network traffic based on predefined security rules. A firewall commonly establishes a block between a trusted internal computer

network and entrusted computer outside the network.

A proxy server acts as an intermediary between the end users and a web server. The proxy server examines the request, checks authenticity and grants the request.

### Encryption and Decryption

Encryption and decryption are processes that ensure confidentiality that only authorized persons can access the information.

Encryption is the process of translating the plain text data (plaintext) into random and mangled data (called cipher-text).

Decryption is the reverse process of converting the cipher-text back to plaintext. Encryption and decryption are done by cryptography. In cryptography a key is a piece of information (parameter) that determines the functional output of a cryptographic algorithm.

Encryption is used to protect data in communication system, for example data being transferred via networks (e.g. the Internet, ecommerce), mobile telephones, wireless microphones, wireless intercom systems, Bluetooth devices and bank automatic teller machines.

## 17.4 INTRODUCTION TO INFORMATION TECHNOLOGY ACT

In the 21st century, Computer, Internet and ICT or e-revolution has changed the life style of the people. Apart from positive side of e-revolution there is also negative side of computer, that

is, the internet and ICT in the hands of criminals. To tackle the problems of cyber crimes Cyber Law or Cyber Space Law or Information Technology Law or Internet Law were introduced.

In India Cyber law and IT Act 2000, modified in 2008 are being articulated to prevent computer crimes. IT Act 2000 is an act to provide legal recognition for transactions carried out by means of **Electronic Data Interchange (EDI)** and other means of electronic communication. It is the primary law in India dealing with cybercrime and electronic commerce (e-Commerce). e-Commerce is electronic data exchange or electronic filing of information.

### PREVENTION

25% of cyber crime remains unsolved. To protect the information the following points are to be noted:

- Complex password setting can make your surfing secured.
- When the internet is not in use, disconnect it.
- Do NOT open spam mail or emails that have an unfamiliar sender.
- When using anti-virus software, keep it up-to-date.

### Evaluation



#### PART - I

Choose the best Answer.



1. Which of the following is a set of moral principles that regulate the use of computers?
  - a. piracy
  - b. programs
  - c. virus
  - d. computer ethics
2. Commercial programs made available to the public illegally are known as
  - a. freeware
  - b. warez
  - c. free software
  - d. software
3. Which one of the following are self-repeating and do not require a computer program to attach themselves?
  - a. viruses
  - b. worms
  - c. spyware
  - d. Trojans
4. Which one of the following tracks a user visits a website?
  - a. spyware
  - b. cookies
  - c. worms
  - d. Trojans
5. Which of the following is not a malicious program on computer systems?
  - a. worms
  - b. Trojans
  - c. spyware
  - d. cookies
6. A computer network security that monitors and controls incoming and outgoing traffic is
  - a. Cookies
  - b. Virus
  - c. Firewall
  - d. worms
7. The process of converting cipher text to plain text is called
  - a. Encryption
  - b. Decryption
  - c. key
  - d. proxy server
8. e-commerce means
  - a. electronic commerce
  - b. electronic data exchange
  - c. electric data exchange
  - d. electronic commercialization.
9. Distributing unwanted e-mail to others is called.
  - a. scam
  - b. spam
  - c. fraud
  - d. spoofing

10. Legal recognition for transactions are carried out by
- Electronic Data Interchange
  - Electronic Data Exchange
  - Electronic Data Transfer
  - Electrical Data Interchange

### Part – II

#### Very Short Answers

- What is Harvesting ?
- What are Warezs?
- Write a short note on cracking.
- Write two types of cyber attacks.
- What is a Cookie?

### Part-III

#### Short Answers

- What is the role of firewalls?
- Write about encryption and decryption.

- What are the guidelines to be followed by any computer user?
- What are ethical issues? Name some.

### Part –IV

#### Explain in Detail

- What are the various crimes happening using computer?
- What is piracy? Mention the types of piracy? How can it be prevented?
- Write the different types of cyber attacks.

#### Reference :

- Computer Network Security and Cyber Ethics by Joseph MiggaKizza
- “Investigating Cyber Law and Cyber Ethics: Issues, Impacts and Practices: 1” by Alfreda Dudley and James Braman

## GLOSSARY

WORD	MEANING
Authenticity	The quality of being real or true.
Computer Crime	Computer crime is an intellectual crime to manipulate computer system.
Ethics	Moral principles that govern a person's behaviour or the conducting of an activity.
Hacking	Hacking is gaining unauthorized access to computer system without the owner's permission.
Perpetrator	A person who carries out a harmful, illegal, or immoral act.
Software Piracy	Software Piracy is the copyright violation of software created originally by one person and illegally used by someone else.

## Tamil Computing



## 18.1 Introduction

“ பிறநாட்டு நல்லறிஞர் சாத்திரங்கள்  
தமிழ்மொழியிற் பெயர்த்தல் வேண்டும்;  
இறவாத புகழுடைய புதுநூல்கள்  
தமிழ்மொழியில் இயற்றல் வேண்டும்;  
மறைவாக நமக்குள்ளே பழங்கதைகள்  
சொல்வதிலோர் மகிமை இல்லை;  
திறமான புலமையெனில் வெளிநாட்டோர்;  
அதை வணக்கஞ் செய்தல் வேண்டும்.”

- மகாகவி பாரதி

Human civilization developed with the innovation of computer in the twentieth century. Computer development began as a early calculating tool and has now become a essential ingredient for gigantic growth for the existence of human life without computers.

It is true that any language will be outdated when it does not have the ability to adapt itself to the changing technologies. Tamil is a living language for thousands of years. Development of modern technologies, does not affect the growth of classical Tamil as it is ready to adopt the growing technological changes. **Tamil is not just a language, it is our identity, our life and our sense.**

“எங்கள் வாழ்வும், எங்கள் வளமும் மங்காத  
தமிழென்று சங்கே முழங்கு” – புரட்சி கவி.

## 18.2 Tamil in Internet

We know that the internet today plays a vital role in every man's life. Internet is the best information technological device, through which we get know information.

In 2017 a study conducted by KPMG a Singapore based organization along with google, reported that, Tamil topped the list, among the most widely used languages in India, where 42% are using the Internet in Tamil

68%<sup>(9)</sup> Internet users consider local language digital content to be more reliable than English

Currently, Tamil (42%<sup>(9)</sup>) has the highest internet adoption levels followed by Hindi and Kannada among the Indian language users

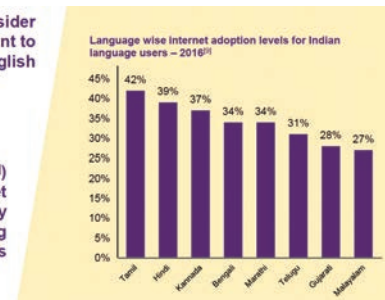

As per study, by 2021, 74% of people in India will access internet using Tamil and it will be in the top usage of Internet in India.

By 2021, the number of Hindi internet users will be more than English users

Marathi, Bengali, Tamil and Telugu internet users are expected to form 30%<sup>[12]</sup> of the total Indian language internet user base

Tamil and Kannada speakers have the highest propensity to adopt internet in future with the Indian language enablement of the ecosystem

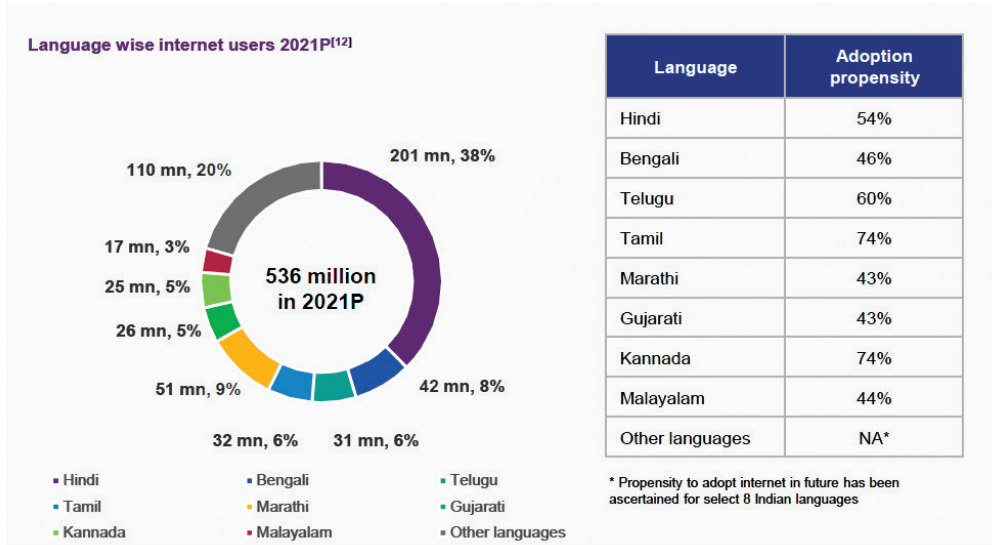

These statistical data will be useful to improve internet services in Tamil.

### 18.3 Search Engines in Tamil

The “Search Engines” are used to search any information from the cyber space. Although there are many search engines, but only a few of them are frequently in use. In the top ten search engines, Google, Bing and Yahoo take first three places respectively. Google and Bing provide searching facilities in Tamil, which means you can search everything through Tamil. The Google search engine gives you an inbuilt Tamil virtual keyboard.

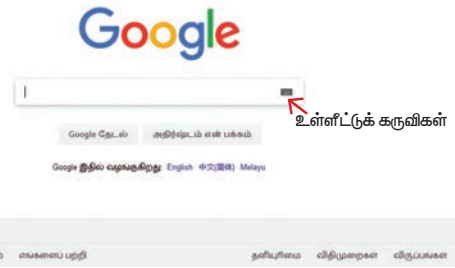

Figure 18.1(b) Google Search Engine (Singapore)

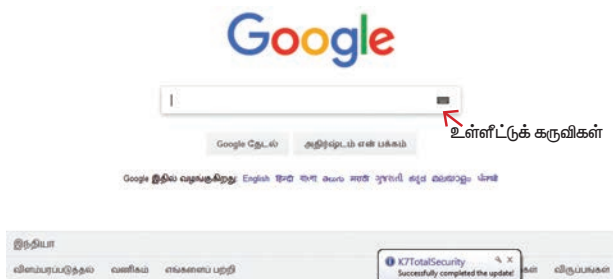

Figure 18.1(a) Google Search Engine (India)

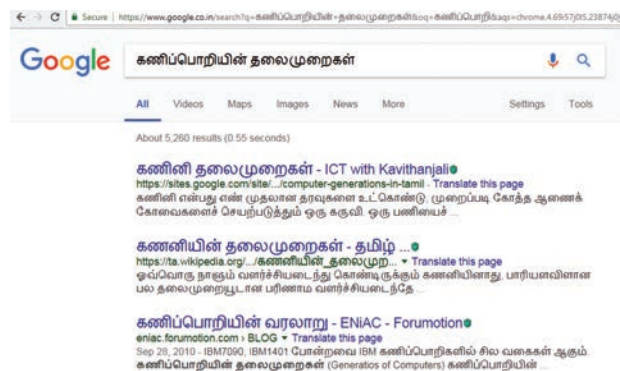

Figure 18.2 Searching in Tamil

### 18.4 e – Governance:

Getting Government services through internet is known as e-Governance. Govt. of Tamilnadu has been giving its services through Internet. One can communicate with Govt. of Tamilnadu from any corner of the World. One can get important announcements, government orders, and government welfare schemes from the web portal of Govt. of. Tamilnadu.



Figure 18.3 Official Website of Govt. of Tamilnadu

E-Governance through Tamil	Web Address
Official Website of Govt. of Tamilnadu	<a href="http://www.tn.gov.in/ta">http://www.tn.gov.in/ta</a>
Department of Agricultural Engineering	<a href="http://www.aed.tn.gov.in/">http://www.aed.tn.gov.in/</a>
Department of Environment	<a href="http://www.environment.tn.nic.in/">http://www.environment.tn.nic.in/</a>
Directorate of Govt. Examinations	<a href="http://www.dge.tn.nic.in/">http://www.dge.tn.nic.in/</a>
Tamilnadu Health Department	<a href="http://www.tnhealth.org/">http://www.tnhealth.org/</a>
Tamilnadu Micro, Small and Medium Enterprises Department	<a href="http://www.msmeonline.tn.gov.in/">http://www.msmeonline.tn.gov.in/</a>
Rural Development and Panchayat Raj Department	<a href="http://www.tnrd.gov.in/">http://www.tnrd.gov.in/</a>
Backward, Most Backward and Minorities Welfare Department	<a href="http://www.bcmbcmw.tn.gov.in/">http://www.bcmbcmw.tn.gov.in/</a>
Tamilnadu Forest Department	<a href="https://www.forests.tn.gov.in/">https://www.forests.tn.gov.in/</a>
Hindu Religious and Charitable Endowments Department.	<a href="http://www.tnhrce.org/">http://www.tnhrce.org/</a>
Tamil Nadu Public Service Commission (TNPSC)	<a href="http://www.tnpsc.gov.in/tamilversion/index.html">http://www.tnpsc.gov.in/tamilversion/index.html</a>
Official Website of Govt. of Srilanka	<a href="https://www.gov.lk/index.php">https://www.gov.lk/index.php</a>

Outside India, Government of Srilanka provides all their services through the official website in Tamil.

### 18.5 e-Library

E-Libraries are portal or website of collection of e-books. Tamil e-Library

services provide thousands of Tamil Books as ebooks mostly at free of cost. It is the most useful service to Tamil people who live far away from their home land.

Tamil e-Library	Website address
Tamilnadu School Education and Teacher Education Training Textbooks and Resource Books	<a href="http://www.textbooksonline.tn.nic.in/">http://www.textbooksonline.tn.nic.in/</a>
Tamil Virtual Academy	<a href="http://www.tamilvu.org/library/libindex.htm">http://www.tamilvu.org/library/libindex.htm</a>
Connemara Public Library	<a href="http://connemarapubliclibrarychennai.com/Veettukku_oru_noolagam/index.html">http://connemarapubliclibrarychennai.com/Veettukku_oru_noolagam/index.html</a>
Tamil Digital Library	<a href="http://tamildigitallibrary.in/">http://tamildigitallibrary.in/</a>
Chennai Library	<a href="http://www.chennaiLibrary.com/">http://www.chennaiLibrary.com/</a>
Thamizhagam	<a href="http://www.thamizhagam.net/parithi/parithi.html">http://www.thamizhagam.net/parithi/parithi.html</a>
Project Madurai	<a href="http://www.projectmadurai.org/pmworks.html">http://www.projectmadurai.org/pmworks.html</a>
Old Books and Manuscripts	<a href="http://www.tamilheritage.org/old/text/ebook/ebook.html">http://www.tamilheritage.org/old/text/ebook/ebook.html</a>
Noolaham	<a href="http://www.noolaham.org/wiki/index.php/">http://www.noolaham.org/wiki/index.php/</a>
Anna Centenary Libraray	<a href="http://www.annacentenarylibrary.org/">http://www.annacentenarylibrary.org/</a>

## 18.6 Tamil Typing and Interface software

Tamil is mostly used to type documents in word processors and search information on the internet. Typing Tamil using Tamil interface software is a familiar one among the different methods of typing. This is the simplest method of typing Tamil in both Computer and Smart phones.

### 18.6.1 Familiar Tamil Keyboard Interface:

- NHM Writer, E-Kalappai and Lippikar – are familiar Tamil keyboard interfaces software that is used for Tamil typing which works on Tamil Unicode, using phonetics.
- Sellinam and Ponmadal – are familiar Tamil keyboard layouts that works on Android operating system in Smart phone using phonetics.



Figure 18.4 eKalappai Opening screen

## 18.7 Tamil Office Automation Applications

Famous Office automation software like Microsoft Office, Open Office etc., provides complete Tamil interface facility. These softwares are downloadable and installed in your computer. After installation, your office automation software environment will completely change to Tamil. Menu bars, names of icons, dialog boxes will be shown in Tamil. Moreover, you can save files with Tamil names and create folders with Tamil names.



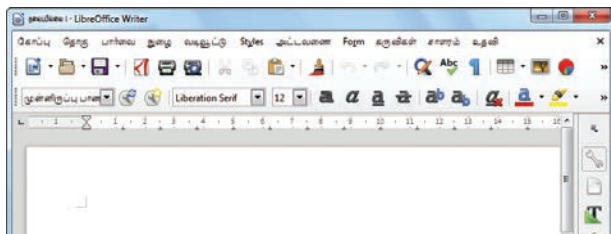

Figure 18.5 Libra Office Writer Environments in Tamil

Apart from that Tamil Libra Office, Tamil Open Office, Azhagi Unicode Editor, Ponmozhi, Menthamiz, Kamban, Vani are office automation software working exclusively for Tamil. You can use these applications to work completely in Tamil.

### 18.8 Tamil Translation Applications

Thamizpori (தமிழ்பொறி) is a Tamil translation application having more than 30000 Tamil words equalent to English words. Using this application, we can translate small english sentences into Tamil. Google also gives an online translation facility.

### 18.9 Tamil Programming Language

Programming languages to develop software in computers and smart phones are available only in English. Based on Python programming language, the first Tamil programming language “Ezhil” (எழில்) is designed.

### 18.10 Tamil Information Interchange Coding Systems

**TSCII (Tamil Script Code for Information Interchange)**

Computers handle data and information as binary system. Computers use ASCII encoding system to handle data and information. The ASCII encoding system is applicable only for handling English language. Therefore, TSCII (Tamil Script Code for Information Interchange) is the first coding system to handle our

Tamil language. This encoding scheme was registered in IANA (Internet Assigned Numbers Authority) a unit of ICANN.

**ISCH (Indian Script Code for Information Interchange)**

This is one of the encoding schemes specially designed for Indian languages including Tamil. It was unified with Unicode.

**Unicode:**

Unicode is an encoding system, designed to handle various world languages, including Tamil. Its first version 1.0.0 was introduced in October 1991. Unicode is the best suitable to handle Tamil.

### 18.11 Tamil Operating System

An operating system is needed to access electronic systems such as computer and smart phone. Microsoft Windows is very popular operating system for personal computers. Linux is another popular open source operating system. Operating systems are used to access a computer easily. An operating system should be easy to work and its environment should be in an understandable form. Thus, all operating systems used in computers and smart phones are offered in Tamil environment.

Windows Tamil Environment interface should be downloaded and installed from the internet. It displays all window elements such as Taskbar, desktop elements, names of icons, commands in Tamil.

### 18.12 Organisation and projects to develop Tamil

**Tamil Virtual Academy:**

With the objectives of spreading Tamil to the entire world through internet, Tamil Virtual University was established on 17th February 2001 by the Govt. of

Tamilnadu. Now, this organisation functions with the name of “Tamil Virtual Academy”. It offers different courses in Tamil language, Culture, heritage etc., from kindergarten to under graduation level.

Website: <http://www.tamilvu.org/index.php>

### Tamil Language Council, Singapore

With the objectives of promoting the awareness and greater use of Tamil among the Singaporeans, in 2001 the council of Tamil Language was formed by the ministry of Information Communications and Arts, Govt. of Singapore. The council is called as “வளர்தமிழ் இயக்கம்”.

Website: <http://tamil.org.sg/ta>

### Madurai Project

Project Madurai is an open and voluntary initiative to collect and publish free electronic editions of ancient tamil

literary classics. This means either typing-in or scanning old books and archiving the text is one of the most readily accessible formats for use on all popular computer platforms.

Since its launch in 1998, Project Madurai etexts released are in Tamil script form as per TSCII encoding. Since 2004 we have started releasing etexts in Tamil unicode as well.

Web Site: <http://www.projectmadurai.org/>

### Tamil Wikipedia:

Wikipedia is a open source encyclopedia where any person can write an article about any subject. There are more than One lakh articles in Tamil Wikipedia.

Web Site: <https://ta.wikipedia.org/>

In order to make Tamil as a living language, it is the duty of every Tamilian to actively use Tamil in the development of technology.

### Points to Remember:

- Tamil topped the list of the most widely used regional languages in India by the end of 2016, among 42% are using the Internet.
- Google and Bing provide searching facilities in Tamil.
- Getting Government services through internet is known as e-Governance.
- Tamil e-Library services provide thousands of Tamil Books as ebooks mostly at free of cost.
- Thamizpori (தமிழ்பொறி) is a Tamil tranlation application having more than 30000 Tamil words equalent to English words.
- The first Tamil programming language is “Ezhil” (எழில்)
- Unicode is an encoding system, designed to handle various world languages, including Tamil.
- Windows Tamil Environment interface should be downloading and install from internet.

### Evaluation



#### Very Short Answers

1. List the search engines supported by Tamil language.
2. What are the keyboard layouts used in Android?
3. Write a short note about Tamil Programming Language.
4. What is TSCII?
5. Write a short note on Tamil Virtual Academy.



### Practical Programs – Hand Book

#### Instructions:

1. One exercise from **Writer, Calc** and **CSS**, Three exercises from **HTML**, and Four exercises from **JavaScript** are to be practiced in the practical classes.
2. Answer to any one question from Practical Book with internal choice
3. Distribution of Marks

I. Internal Assessment: 5 Marks

Record Book 5 Marks

II. External Assessment: 15 Marks

(a) Writer or Calc – Procedure 10 Marks  
HTML or CSS or JavaScript – Coding

(b) Execution & Output 5 Marks

<b>Total</b>	<b>20 Marks</b>
--------------	-----------------

#### INDEX

Sl. No.	Question Number	Program Name
1	CA1	Open Office Writer - Formatting Invoice
2	CA2	Open Office Calc – Interest Calculation
3	CA3	HTML – Form Design
4	CA4	HTML – Height and Weight Table
5	CA5	HTML – Nested List
6	CA6	CSS – Formatting Webpage
7	CA7	JavaScript – Display Text
8	CA8	JavaScript – Multiplication Table
9	CA9	JavaScript – Display Weekdays in Words
10	CA10	JavaScript – Login Form

## CA1 – FORMATTING INVOICE

CA-1

Type the following Invoice in OpenOffice Writer and apply the formatting features as given below:

<b>Invoice</b>			
<b>SAIRAM MEDICAL STORES</b>			
Mobile No : 9002416000		P.B.No: 617	
Mail Address : sairam@gmail.com		70, New Avadi Road,	
		Chennai 600 010.	
No: 70/162			
M/s. <b>Eswari Medical Stores,</b>		23rd Nov 2017	
No: 72, N.S.C. Bose Road,			
Puduchery - 6210110			
Quantity (Nos)	Particulars	Rate	Amount
20	Johnson Baby Powder	25	500
10	Nestle Milk Powder	100	1000
5	Wood Wards Gripe Water	70	350
<b>Total</b>			
	Add: GST @ 3%		
<b>Net Payable</b>			

For Sriram Medical Stores  
Sales Manager

- Use formula to calculate Total and Net Payable

**Procedure**

**Step-1.** OpenOffice Writer and choose Text document or **File** → **New** → **Text Document**.

**Step-2.** Type the text and apply the format as per the given format.

**Note:** Select the required text before formatting.

Text	Format	Method
INVOICE	Center and apply red	<b>Ctrl + E</b> and choose <b>Red</b> color from font color pallete or any method.
SAIRAM MEDICAL STORES	Center and apply blue	<b>Ctrl + E</b> and <b>Blue</b> color from font color pallete or any method.
Eswari Medical Stores	Bold	<b>Ctrl + B</b> or any method.

**Step-3** Create a table using any one of the method **Ctrl + F12** or **Insert → Table or Table → Insert → Table** or **Insert Table** icon from toolbar. with 4 columns and 7 rows

**Step-4.** Enter the data as per the given format.

**Step-5.** Select first three columns in 5th Row and **Right Click → Cell → Merge** and type as "Total"

**Step-6.** Repeat Step-5 for 7th Row, and type as "Net payable"

**Step-7.** To find the Total, Enter the following formula at Total → Amount Column as =<D2>+<D3>+<D4> OR = Sum (<D2:D4>)

**Step-8.** To find the GST @ 3% Enter the formula as = <B5> \*0.03

**Step-9.** To calculate Netpayable amount, Enter the formula as =<B5>+<D6>

### Output

<b>Invoice</b>			
<b>SAIRAM MEDICAL STORES</b>			
Mobile No : 9002416000		P.B.No: 617	
Mail Address : sairam@gmail.com		70, New Avadi Road,	
		Chennai 600 010.	
No: 70/162			
M/s. <b>Eswari Medical Stores,</b>		23rd Nov 2017	
No: 72, N.S.C. Bose Road,			
Puduchery - 6210110			
Quantity (Nos)	Particulars	Rate	Amount
20	Johnson Baby Powder	25	500
10	Nestle Milk Powder	100	1000
5	Wood Wards Gripe Water	70	350
<b>Total</b>			<b>1850</b>
	Add: GST @ 3%		55.5
<b>Net Payable</b>			<b>1905.5</b>
For Sriram Medical Stores			
Sales Manager			

### CA2 - INTEREST CALCULATION

**CA-2** Create statement of interest using OpenOffice Calc with the following particulars:

Sara Ltd., sells goods. Their policy is to charge interest @ 2% p.a., for the number of days. From the following data, find out the amount to be collected from each customer. Assume 365 days in the year.

Customer	Sales	Date of Sale	NO. of days	Date of settlement
Tharani	25000	10/04/2017	60	
Mahalakshmi	14000	28/05/2017	30	
Kumar	28000	14/07/2017	45	
Arulmozhi	54000	03/08/2017	90	

### Procedure

Step -1. Open OpenOffice Calc and choose Spreadsheet or **File** → **New** → **Spreadsheet**.

Step -2. Type the Headings in cell A1 to E1 (*Customer, Sales, Date of Sale, Number of days and Date of settlement*) as per the given data.

Step -3. In cell F1 and G1 type (*Interest Amt and Amount to be paid*) respectively.

Step -4. In cell E2 enter the formula = C2 + D2 to arrive the date of settlement and to the remaining cells (E2 to E5). Use **Edit** → **Fill** → **Down** command

Step -5. In cell F2 enter the formula =ROUND((B2\*2/100)\*D2/365) to arrive the Interest amount to the remaining cells (F2 to F5). Use **Edit** → **Fill** → **Down** command

Step -6. In cell G2 enter the formula = B2 + F2 to arrive the Amount to be paid to the remaining cells (G2 to G5). Use **Edit** → **Fill** → **Down** command

### Output

	A	B	C	D	E	F	G
1	Customer	Sales	Date of Sale	No.of days	Date of Settlement	Interest Amt	Amount to be Paid
2	Tharani	25000	10-04-2017	60	09-06-2017	82	25082
3	Mahalakshmi	14000	28-05-2017	30	27-06-2017	23	14023
4	Kumar	28000	14-07-2017	45	28-08-2017	69	28069
5	Arulmozhi	54000	03-08-2017	90	01-11-2017	266	54266

## CA3 – FORM DESIGN

**CA-3** Write an HTML code to design a form like the one shown below.

### Registration Form

User Name:

Password:

Re-type Password:

Gender:  Male  Female

#### Additional Information

Optional Subject:

Put me on mail list

### Coding

```

<html>
<head>
<title> User Registration </title>
</head>
<body>
<h1 align = center> Registration Form </h1>
<form id=reg_form method = post action = " ">
User Name: <input type = text name=uname > <br><br>
Password: <input type = password name=pword1 > <br><br>
Re-type Password: <input type = password name=pword2 > <br><br>
Gender:
<input type = radio name=male value="M" > Male
<input type = radio name=female value="F" > Female
<h2 align=center> Additional Information </h2>
Optional Subject:
<select name=subj>
    <option value = CT> Computer Technology
    <option value = Paint> Painting
    <option value = SG> Sports and Games
</select>
<br><br>
<input type = checkbox name=mail > Put me on mail list <br> <br>
<input type = reset value=Reset >
<input type = submit value=Submit >
</form>
</body>
</html>

```

### Output

## CA4 - HEIGHT AND WEIGHT TABLE

**CA-4** Write an HTML code to display the following.**Height and Weight**

Name	Class	Height	Weight
Mani	XII - G	5'0"	45
Vasu	XI - H	5'4"	49
Murali	XI - B	5'1"	51
Pallavai	XII - D	4'5"	50

**Coding**

```
<html>
<head>
<title> Height and Weight Table </title>
<head>
<body>
<table border=10>
<caption> Height and Weight </caption>
<tr>
<th width=40%> Name </th>
<th width=20%> Class </th>
<th width=20%> Height </th>
<th width=20%> Weight </th>
</tr>
<tr>
<td> Mani </td>
<td> XII - G </td>
<td> 5'0" </td>
<td> 45 </td>
</tr>
<tr>
<td> Vasu </td>
<td> XI - H </td>
<td> 5'4" </td>
<td> 49 </td>
</tr>
<tr>
<td> Murali </td>
<td> XI - B </td>
```



```

<td> 5'1" </td>
<td> 51 </td>
</tr>
<tr>
<td> Pallavai </td>
<td> XII - D </td>
<td> 4'5" </td>
<td> 50 </td>
</tr>
</table>
</body>
</html>

```

### Output

Height and Weight			
Name	Class	Height	Weight
Mani	XII - G	5'0"	45
Vasu	XI - H	5'4"	49
Murali	XI - B	5'1"	51
Pallavai	XII - D	4'5"	50

### CA5 - NESTED LIST

#### CA-5

Write an HTML code to create a webpage to display the following sets of lists:

1. Tamilnadu a. Chennai b. Madurai	<ul style="list-style-type: none"> <li>• Languages               <ul style="list-style-type: none"> <li>o Tamil</li> <li>o Malayalam</li> <li>o Telugu</li> </ul> </li> </ul>
2. Andhra Pradesh a. Amaravathi b. Vijayawada	<ul style="list-style-type: none"> <li>• Science               <ul style="list-style-type: none"> <li>o Physics</li> <li>o Chemistry</li> <li>o Zoology</li> </ul> </li> </ul>
3. Kerala a. Thiruvananthapuram b. Cochin	<ul style="list-style-type: none"> <li>• Humanities               <ul style="list-style-type: none"> <li>o History</li> <li>o Commerce</li> <li>o Economics</li> </ul> </li> </ul>

**Coding**

```

<html>
<head>
<title> Sets of Lists </title>
</head>
<body>
<OL>
  <LI> Tamilnadu
    <OL type=a>
      <LI> Chennai
      <LI> Madurai
    </OL>
  <LI> Andhra Pradesh
    <OL type=a>
      <LI> Amaravathi
      <LI> Vijayawada
    </OL>
  <LI> Kerala
    <OL type=a>
      <LI> Thiruvananthapuram
      <LI> Cochin
    </OL>
</OL>
</UL>
<LI> Languages
  <UL type=circle>
    <LI> Tamil
    <LI> Malayalam
    <LI> Telugu
  </UL>
<LI> Science
  <UL type=circle>
    <LI> Physics
    <LI> Chemistry
    <LI> Zoology
  </UL>
<LI> Humanities
  <UL type=circle>
    <LI> History
    <LI> Commerce
    <LI> Economics
  </UL>
</UL>
</body>
</html>

```

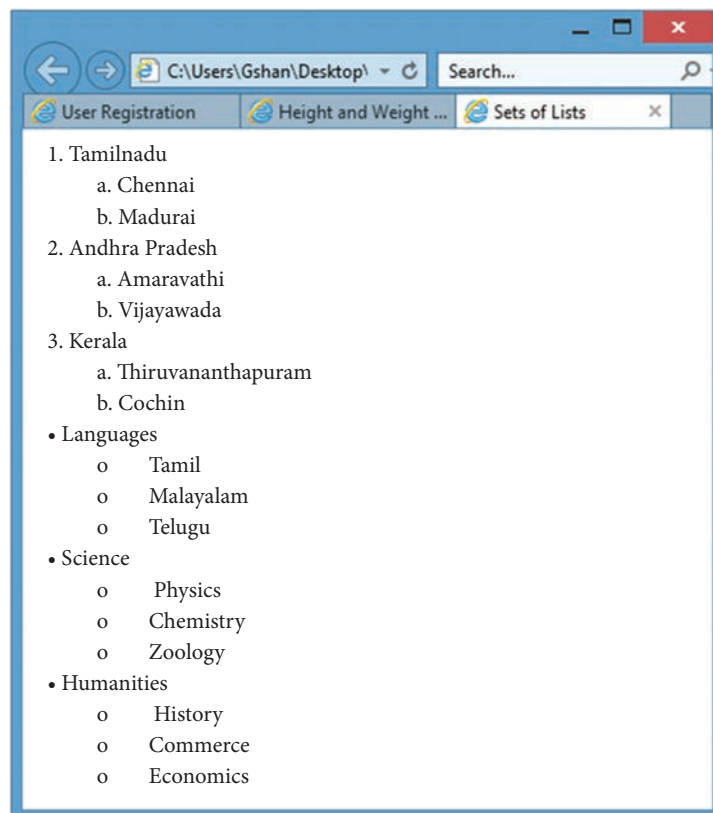
**Output**

## CA6 - FORMATTING WEBPAGE

## CA-6 Create a webpage as given description using CSS

## Tamil

Tamil is a Dravidian language predominantly spoken by the Tamil people of India and Sri Lanka, and by the Tamil diaspora, Sri Lankan Moors, Burghers, Douglas, and Chindians. Tamil is an official language of two countries: Sri Lanka and Singapore.

It has official status in the Indian state of Tamil Nadu and the Indian Union Territory of Puducherry. It is used as one of the languages of education in Malaysia, along with English, Malay and Mandarin.

Tamil is spoken by significant minorities in the four other South Indian states of Kerala, Karnataka, Andhra Pradesh and Telangana and the Union Territory of the Andaman and Nicobar Islands. It is one of the 22 scheduled languages of India.

## Description:

Element	Font	Style	Alignment	Color
H1	Arial Black	-	Center	Border 2px solid blue
P1	Century	Bold	-	Red
P2	Bookman Old Style	Italic	-	Blue
P3	Century Gothic	-	-	Green

**Note:** Create two files. 1. Mystyle.css and 2. CA6.html

## Coding -1

## Mystyle.css

```
H1
{
font-family: "Arial Black";
text-align:center;
border : 2px solid blue;
}
P1
{
font-family: "Century";
font-style : Bold;
```

```
color : Red;
}
P2
{
font-family: "Bookman Old Style";
font-style : Italic;
color : Blue;
}
P3
{
font-family: "Century Gothic";
color : Green;
}
```

**Coding -2****CA6.html**

```

<html>
<head>
<title> Tamil </title>
<link rel="stylesheet" type="text/css"
      href="mystyle.css">
</head>
<body>
<H1> Tamil </H1>
<P1>
Tamil is a Dravidian language predominant-
ly spoken
by the Tamil people of India and Sri Lanka,
and by the
Tamil diaspora, Sri Lankan Moors, Bur-
ghers, Douglas,
and Chindians. Tamil is an official language
of two countries:
Sri Lanka and Singapore.
</P1> <br> <P2>

```

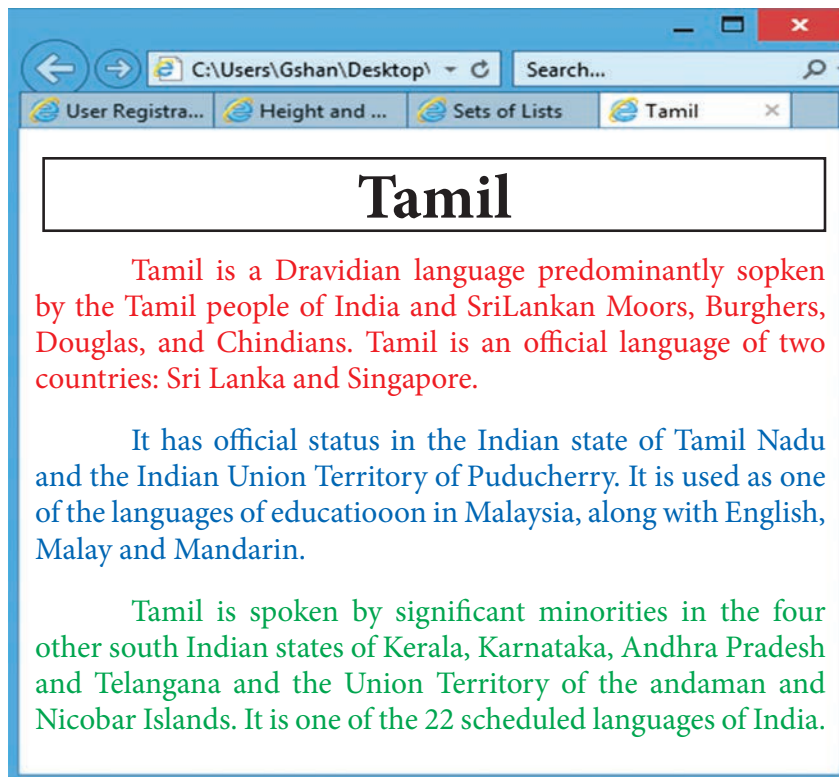
**Output**

It has official status in the Indian state of Tamil Nadu and the Indian Union Territory of Puducherry.

It is used as one of the languages of education in Malaysia, along with English, Malay and Mandarin.

</P2> <br> <P3>

Tamil is spoken by significant minorities in the four other

South Indian states of Kerala, Karnataka, Andhra Pradesh

and Telangana and the Union Territory of the Andaman and

Nicobar Islands. It is one of the 22 scheduled languages of

India.

</P3>

</body>

</html>

## CA7 - DISPLAY TEXT

**CA-7** Create a webpage using JavaScript to display the following text.

**Welcome to JavaScript  
State Council of Educational Research and Training (SCERT),  
Tamilnadu, Chennai.**

**Coding**

```
<html>
<head>
<title> Display text using JavaScript </title>
</head>
<body align=center>
<p>
<script>
document.write ("<h1 align=center>Welcome to JavaScript <br>");
document.write ("State Council of Educational Research and Training (SCERT),<br>");
document.write ("Tamilnadu, Chennai. </h1>");
</script>
</p>
</body>
</html>
```

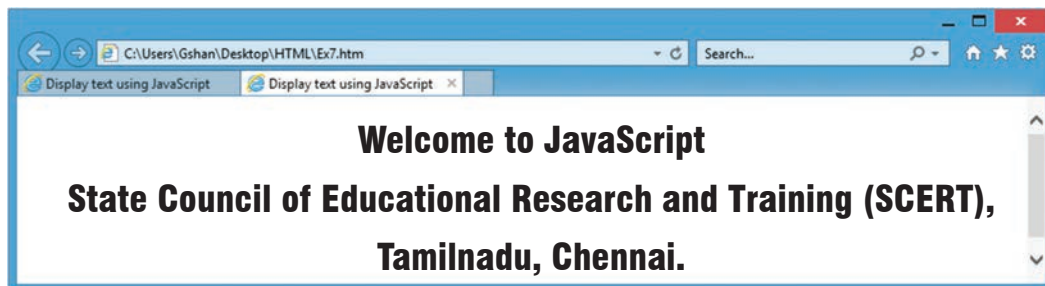
**Output**

## CA8 - MULTIPLICATION TABLE

**CA-8** Create a webpage using JavaScript to display multiplication table by prompting number of rows and columns.

**Coding**

```
<html>
<head>
<title>Multiplication Table</title>
<script type="text/javascript">
var rows = prompt("How many rows for your multiplication table?");
var cols = prompt("How many columns for your multiplication table?");
```

```

if(rows == "" || rows == null)
    rows = 10;
if(cols == "" || cols == null)
    cols = 10;
createTable(rows, cols);
function createTable(rows, cols)
{
    var j=1;
    var output = "<table border='1' width='500'
cellspacing='0'cellpadding='5'>";
    for(i=1;i<=rows;i++)
    {
        output = output + "<tr>";
        while(j<=cols)
        {
            output = output + "<td>" + i*j + "</
td>";
            j = j+1;
        }
        output = output + "</tr>";
        j = 1;
    }
    output = output + "</table>";
    document.write(output);
}
</script>
</head>
<body>
</body>
</html>

```

## Output

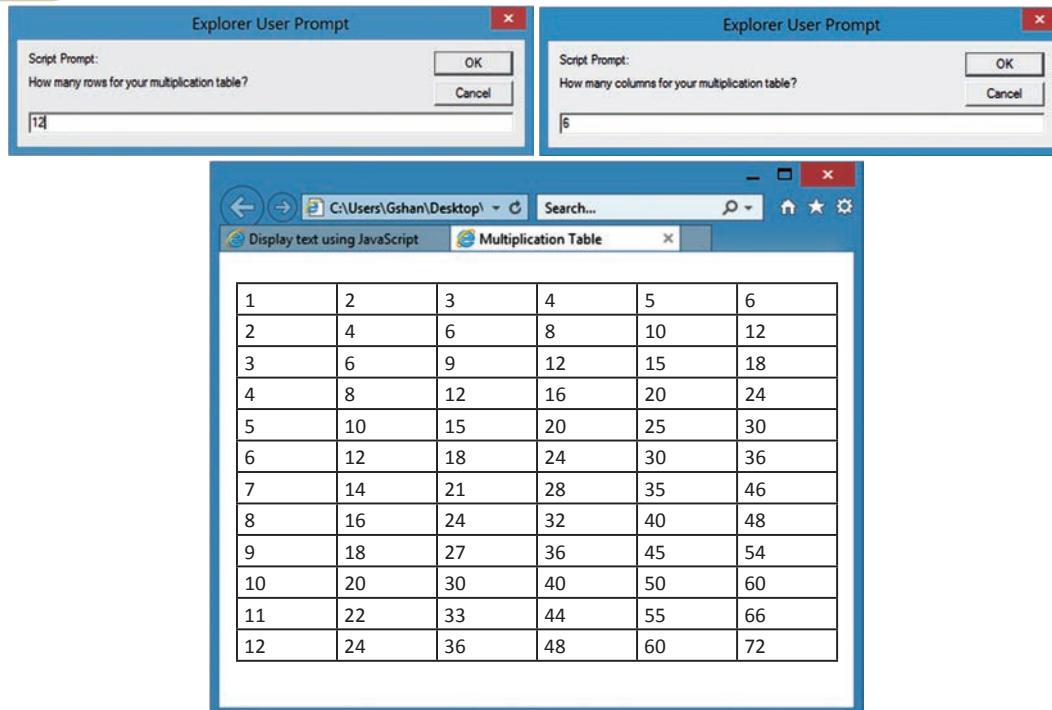

## CA9 - DISPLAY WEEKDAYS IN WORDS

**CA-9** Create a webpage using JavaScript to display Weekday in words by getting input as a number using switch.

### Coding

```

<html>
<head>
<title> Weekday </title>
<script type="text/javascript">
var n=prompt("Enter a number between 1
and 7");
switch (n)

```

```

{
case (n="1"):
document.write("Sunday");
break;
case (n="2"):
document.write("Monday");
break;
case (n="3"):

```

```

document.write("Tuesday");
break;
case (n="4"):
document.write("Wednesday");
break;
case (n="5"):
document.write("Thursday");
break;
case (n="6"):
document.write("Friday");
break;
case (n="7"):
document.write("Saturday");
break;
default:
document.write("Invalid Weekday");

```

```

break;
}
</script>
</head>
</html>

```

### Output

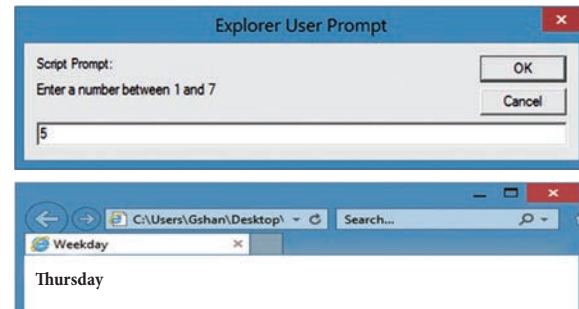

## CA10 - LOGIN FORM

**CA-10** Create a Form using JavaScript to get username, password and address, validate the inputs.

### Coding

```

<html>
<head>
<script type="text/javascript">
function sub()
{
if(document.getElementById("t1").
value == "")
alert("Please enter your name");
else if(document.getElementById("t2").
value == "")
alert("Please enter a password");
else if(document.getElementById("t2").
value != document.getElementById("t3").
value)
alert("Please enter correct password");
else if(document.getElementById("t4").
value == "")
alert("Please enter your address");
else
alert("Form has been submitted");
}
</script>
</head>
<body>
<form>

```

```

<p align="center">
User Name:<input type="text"
id="t1"><br><br>
Password:<input type="text"
id="t2"><br><br>
Confirm Password:<input type="text"
id="t3"><br><br>
Address:<textarea rows="2" cols="25"
id="t4"></textarea><br><br>
<input type="button" value="Submit" on-
click="sub()">
<input type="reset" value="Clear All">
</p>
</form>
</body>
</html>

```

### Output



# COMPUTER APPLICATIONS – XI

## List of Authors and Reviewers

### Domain Experts

#### Dr. T.V. Gopal

Professor,  
Dept. of Computer Science and Technology,  
College of Engineering, Guindy, Anna University, Chennai.

#### Mrs. Bagyalakshmi P.

Asst. Professor and Head of the Department,  
Dept. of Computer Applications, Queen Mary's College, Chennai.

#### Mrs. Sasikala k

Associate Professor, Dept of Computer Science, Queen Mary's College, Chennai

#### Dr. Chitra Babu

Professor and Head of the Department, Dept of Computer Science and Engineering, SSN  
College of Engineering, Chennai

#### Dr. Radha P

Assistant Professor, Dept of Information Technology,  
Govt. Arts & Science College (A), Coimbatore

#### Dr. Nester Jeyakumar M

Associate Professor and Head Of the Department,  
Dept of Computer Science, Loyola College, Chennai

#### Dr. Srinivasan N

Professor, Dept of Computer Science and Engineering,  
Sathyabama Institute of Science & Technology, Chennai

#### Dr. Chandra Mohan B

Associate Professor, School of Computer Science and Engineering, Vellore Institute of  
Technology, Vellore

#### Mr. Sethuraman R

Assistant Professor, Dept of Computer Science and Engineering, Sathyabama Institute of  
Science & Technology, Chennai

#### Mr. Sankar K

Assistant Professor, Dept of Computer Science,  
RKM Vivekananda College, Mylapore, Chennai

### Reviewers

#### Dr. Ranjani Parthasarathi

Professor,  
Dept. of Info Science and Technology,  
College of Engineering, Guindy, Anna University, Chennai.

#### Mr. Munivel E

Scientist/Engineer 'C' IT Group (Information Security), NIELIT  
Calicut (MeitY, Govt. of India), NIT Campus, Calicut - KL (IN).

### Content Experts

#### Dr. Radha P

Assistant Professor,  
Dept. of Information Technology,  
Govt. Arts & Science College (A), Coimbatore.

#### Dr. Nester Jeyakumar M

Associate Professor and Head of the Department,  
Dept. of Computer Science, Loyola College, Chennai.

## Art and Design Team

#### Layout

THY Designers and Computers  
Chennai

#### QC

Manohar Radhakrishnan  
Gopu Rasuvel

#### Wrapper Design

Kathir Arumugham

#### Co-ordination

Ramesh Munisamy

#### Typist

T. Meena

### Authors

#### Mr. Ramakrishnan V. G.

Post Graduate Teacher,  
Karnataka Sangha Hr Sec School, T.Nagar, Chennai.

#### Mr. Kannan K.

Post Graduate Teacher,  
Chennai Girls Hr. Sec School, Rotler Street, Chennai.

#### Mrs. Bindhu Mohandas

Post Graduate Teacher,  
Vijayanta Model Hr. Sec. School, H.V.F Estate, Avadi, Chennai.

#### Mr. Gowrisankar N.V.

Post Graduate Teacher,  
Chennai Girls Hr. Sec School, Nungambakkam, Chennai.

#### Mr. Sreenivasan R.

Post Graduate Teacher,  
Santhome Hr. Sec. School, Mylapore, Chennai.

#### Mr. Lenin K.

Post Graduate Teacher,  
Chennai Girls Hr Sec School, Saidapet, Chennai

#### Miss. Sangeetha A.

Post Graduate Teacher,  
Govt. Hr. Sec. School, Rajanthangal, Thiruvannamalai.

#### Dr. Valarmathi K.E.

Post Graduate Teacher,  
Academic Council, Velammal Vidhyashram, Surapet, Chennai.

#### Mrs. Gajalakshmi R.

Post Graduate Teacher,  
Jaigopal Garodia Hindu Vidyalaya Hr. Sec School, West Mambalam,  
Chennai.

#### Dr. (Mrs). Vidhya H.

Post Graduate Teacher,  
DAV Boys Senior Seconary School, Gopalapuram, Chennai.

### Academic Coordinators

#### Mr. Ravikumar Arumugam

Deputy Director,  
State Council of Educational Research and Training, Chennai.

#### Mrs. Tamil Selvi R.

B.T. Assistant,  
Government High School, Poonampalayam, Trichy Dist.

#### Mr. A. Palanivel Raj

Assistant Professor, SCERT, Chennai

#### Mrs. Nevedha Selvaraj

Assistant Professor, SCERT, Chennai

### QR Code Team

#### R. Jaganathan,

S.G.T., PUMS, Ganesapuram- Polur, Thiruvannamalai Dist.

#### N. Jagan,

B.T. Asst., GBHSS, Uthiramerur, Kancheepuram Dist.

#### J.F. Paul Edwin Roy,

B.T. Asst., PUMS, Rakkipatti, Salem Dist.

This book has been printed on 80 G.S.M.  
Elegant Maplitho paper.

Printed by offset at: